

Quantitative Risk Assessment of the State-Licensed Radioactive Waste Disposal Area



Prepared for
New York State Energy Research and Development Authority
West Valley, New York
August 11, 2009

Quantitative Risk Assessment of the State-Licensed Radioactive Waste Disposal Area

Prepared by

B. John Garrick, Study Director
John W. Stetkar, Principal Investigator
Andrew A. Dykes
Thomas E. Potter
Stephen L. Wampler

Prepared for
New York State Energy Research and Development Authority
West Valley, New York
August 11, 2009

ACKNOWLEDGMENTS

This quantitative risk assessment (QRA) of the State-Licensed Radioactive Waste Disposal Area (SDA) had many contributors, including the investigators and authors of the numerous technical reports forming the general knowledge base of the Western New York Nuclear Service Center. Two groups were especially important to making this study possible.

The first is the New York State Energy Research and Development Authority (NYSERDA) staff associated with the West Valley Site Management Program, West Valley, New York. The SDA QRA team wishes to especially acknowledge the contributions of Paul J. Bembia, Program Director, and members of the technical staff Tom H. Attridge, John C. Kelly, Andrea L. Mellon, Michael R. Weishan, Jean L. Williams, and Marty J. Willett.

The second group is the NYSERDA Independent Expert Review Team (IERT), whose chairman served as the Study Director of the SDA QRA. Members of IERT making major contributions to the SDA QRA were Sean J. Bennett, Robert H. Fakundiny, Shlomo P. Neuman, Peter N. Swift, and Michael P. Wilson.

ACRONYMS AND ABBREVIATIONS

ALARA	As Low As Reasonably Achievable
Center	Western New York Nuclear Service Center
CDF	Complementary Distribution Function
DEIS	Draft Environmental Impact Statement
DOE	U.S. Department of Energy
EIS	Environmental Impact Statement
EPRI	Electric Power Research Institute
HLW	High level Waste
IERT	Independent Expert Review Team
KRS	Kent Recessional Sequence
KRU	Kent Recessional Unit
KT	Kent Till
LLNL	Lawrence Livermore National Laboratory
LLW	Low Level Waste
LOCA	Loss of Coolant Accident
LTR	License Termination Rule
MOA	Military Operations Area
NASA	National Aeronautics and Space Administration
NCRP	National Council on Radiation Protection
NDA	NRC-Licensed Disposal Area
NFS	Nuclear Fuel Services
NGVD	National Geodetic Vertical Datum
MMI	Modified Mercalli Intensity
NRC	U.S. Nuclear Regulatory Commission
NTS	Nevada Test Site
NTSB	National Transportation Safety Board
NYSERDA	New York State Energy Research and Development Authority
PGA	Peak Ground Acceleration
PMP	Probable Maximum Precipitation
PSHA	Probabilistic Seismic Hazard Assessment
PVC	Poly Vinyl Chloride
QRA	Quantitative Risk Assessment
RCRA	Resource Conservation and Recovery Act
SDA	State-Licensed Disposal Area
SSHAC	Senior Seismic Hazard Analysis Committee
SOG	Seismicity Owners Group
TEDE	Total Effective Dose Equivalent
TFI	Technical Facilitator Integrator
TRU	Transuranic
ULT	Unweathered Lavery Till
USGS	US Geological Survey
VFR	Visual Flight Rules
VLDPE	Very Low Density Polyethylene
WIPP	Waste Isolation Pilot Plant
WLT	Weathered Lavery Till

ACRONYMS AND ABBREVIATIONS (continued)

WMA	Waste Management Area
WNYNSC	Western New York Nuclear Service Center
WVDP	West Valley Demonstration Project
WVSMP	West Valley Site Management Program
YMP	Yucca Mountain Project

TABLE OF CONTENTS

Section	Page
ACRONYMS	iv
EXECUTIVE SUMMARY	ES-1
1 BACKGROUND AND INTRODUCTION	1-1
1.1 References	1-3
2 QRA METHODOLOGY	2-1
2.1 References	2-3
3 QRA SCOPE	3-1
3.1 Definition of Risk	3-1
3.2 Locations and Characteristics of Receptors	3-1
3.3 Transport Pathways	3-2
3.4 Locations and Types of Radiation Hazards	3-2
3.5 Site Administrative Controls and Operations	3-3
3.6 Scope of Analyzed Threats	3-3
4 DESCRIPTION OF THE STATE-LICENSED DISPOSAL AREA	4-1
4.1 History of Operations	4-1
4.2 Site Geohydrology	4-3
4.3 Trench Data and Radionuclide Inventories	4-4
4.4 References	4-5
4A Appendix – SDA Trench Radionuclide Inventories	4-12
5 THREAT ANALYSIS	5-1
5.1 Screening of SDA Threats	5-2
5.1.1 Disruptive Events	5-2
5.1.2 Nominal Events and Processes	5-12
5.1.3 References	5-15
5.2 Precipitation	5-24
5.2.1 Data Sources	5-24
5.2.2 Extrapolation of Historic Experience	5-27
5.2.3 Composite Precipitation Exceedance Curves	5-28
5.2.4 References	5-29
5.3 High Winds	5-52
5.3.1 Data Sources	5-52
5.3.2 Extrapolation of Historic Experience	5-54
5.3.3 Composite High Wind Exceedance Curves	5-55
5.3.4 References	5-56

TABLE OF CONTENTS (continued)

Section	Page
5.4	Tornadoes 5-62
5.4.1	Tornado Touchdown Frequency 5-62
5.4.2	Tornado Damage Area 5-63
5.4.3	Frequency of Tornado Impacts at SDA Site 5-64
5.4.4	References 5-65
5.5	Seismic Hazard 5-80
5.5.1	Available Hazard Analyses 5-80
5.5.2	Evaluation of Uncertainties and Extrapolation of Hazard Curves 5-81
5.5.3	Composite Seismic Hazard Curves 5-82
5.5.4	References 5-83
5.6	Aircraft Crashes 5-94
5.6.1	Commercial Aircraft Crash Frequency 5-94
5.6.2	Military Aircraft Crash Frequency 5-103
5.6.3	General Aviation Aircraft Crash Frequency 5-105
5.6.4	References 5-109
5.7	Meteorite Impacts 5-113
5.7.1	Data Sources 5-113
5.7.2	Frequency Extrapolations 5-113
5.7.3	Meteorite Impact Frequencies 5-114
5.7.4	References 5-115
5.8	Fires 5-121
5.8.1	Wildfires 5-121
5.8.2	Gas Pipeline Fires 5-124
5.8.3	References 5-127
6	FRAGILITY ANALYSES 6-1
6.1	Expert Elicitations 6-2
6.1.1	Elicitation Sessions 6-2
6.1.2	Participating Experts 6-2
6.1.3	Elicitation Process 6-3
6.1.4	Evaluated Issues 6-3
6.1.5	Additional Expert Consultations 6-4
6.1A	Appendix – Expert Elicitation Methodology 6-6
6.2	Seismic-Induced Slope Failure Analyses 6-26
6.2.1	Analysis Methodology and Models 6-26
6.2.2	Seismic-Induced Slope Failures 6-31
6.2.3	Seismic-Induced Slope Failure Fragilities for SDA Models 6-36
6.2.4	References 6-38
6.3	Landslides from Non-Seismic Causes 6-56
6.3.1	Localized Failures of SDA Slopes 6-56
6.3.2	A Regionally Disruptive Landslide 6-58
6.3.3	Extension and Application of the Analyses 6-59
6.3.4	References 6-64

TABLE OF CONTENTS (continued)

Section	Page	
6.4	Trench Cap and Slope Gully Erosion	6-77
6.4.1	Introduction	6-77
6.4.2	Rill and Gully Erosion on the SDA with the Cover Removed	6-77
6.4.3	Gully Erosion on the Slopes Adjacent to the SDA	6-83
6.4.4	Application of the Analyses	6-86
6.4.5	References	6-89
6.5	Groundwater Pathways	6-106
6.5.1	Problem Statement	6-106
6.5.2	Proposed Transport Model	6-106
6.5.3	Flow Model	6-108
6.5.4	Assessment of Uncertainty	6-109
6.5.5	Application of the Analyses	6-110
6.5.6	References	6-116
6.5A	Appendix – Groundwater Flow / Transport Models	6-117
6.5B	Appendix – Uncertainties in Water Flow from Trenches	6-136
6.6	Trench Fluid Volumes and Release Volumes	6-140
6.6.1	Trench Fluid Volumes and Overflow Scenarios	6-140
6.6.2	Other Trench Filling Scenarios	6-141
6.6.3	References	6-143
6.7	Trench Water Levels	6-147
6.7.1	Conditions for Water Intrusion	6-147
6.7.2	Analysis Methodology and Models	6-149
6.7.3	Data and Assumptions	6-152
6.7.4	Analyses	6-155
6.7.5	Summary of Results	6-170
6.7.6	References	6-171
7	MITIGATION SYSTEMS ANALYSIS	7-1
7.1	Mitigation Responses	7-2
7.1.1	Scenario 1 – Aircraft Crash	7-2
7.1.2	Scenario 2 – Tornado	7-3
7.1.3	Scenario 3 – Earthquake	7-4
7.1.4	Scenario 4 – Slope Erosion	7-5
7.1.5	Scenario 5 – Trench Overflow	7-6
7.1.6	Scenario 6 – Groundwater Outflow	7-7
7.1.7	References	7-8
7.2	Geomembrane Unavailability	7-10
7.2.1	System Description	7-10
7.2.2	Inspection and Maintenance History	7-11
7.2.3	Contributors to Unavailability	7-12
7.2.4	Quantification of Unavailability	7-14
7.2.5	References	7-19

TABLE OF CONTENTS (continued)

Section	Page
7.3 Trench Cap Erosion	7-25
7.3.1 Trench Cap Erosion Fragilities	7-25
7.3.2 Precipitation Events	7-25
7.3.3 Quantification of Failure Frequency	7-26
8 SCENARIO ANALYSIS	8-1
8.1 Scenario Framework	8-2
8.1.1 Risk Model Framework	8-2
8.1.2 Release Mechanisms	8-4
8.2 Release Mechanism 1	8-7
8.2.1 Threat Conditions	8-7
8.2.2 Analysis Framework	8-7
8.2.3 Analyzed Scenarios	8-15
8.2.4 General Characteristics of Releases	8-16
8.2.5 References	8-17
8.3 Release Mechanism 2	8-19
8.3.1 Threat Conditions	8-19
8.3.2 Analysis Framework	8-19
8.3.3 Analyzed Scenarios	8-20
8.3.4 General Characteristics of Releases	8-21
8.4 Release Mechanism 3	8-23
8.4.1 Threat Conditions	8-23
8.4.2 Analysis Framework	8-23
8.4.3 Analyzed Scenarios	8-28
8.4.4 General Characteristics of Releases	8-45
8.5 Release Mechanism 4	8-49
8.5.1 Threat Conditions	8-49
8.5.2 Analysis Framework	8-49
8.5.3 Analyzed Scenarios	8-50
8.5.4 General Characteristics of Releases	8-56
8.6 Release Mechanism 5	8-60
8.6.1 Threat Conditions	8-60
8.6.2 Analysis Framework	8-60
8.6.3 Analyzed Scenarios	8-61
8.6.4 General Characteristics of Releases	8-61
8.7 Scenario Interdependencies	8-62
8.7.1 Damaging Events without Correlated Precipitation	8-62
8.7.2 Damaging Events with Correlated Precipitation	8-63
8.7.3 Precipitation without Correlated Damage	8-63

TABLE OF CONTENTS (continued)

Section	Page
9 RELEASE CATEGORIES	9-1
9.1 General Discussion	9-2
9.2 Trench Radionuclide Inventories and Concentrations	9-4
9.2.1 References	9-7
9.3 Release Category Quantification	9-12
9.3.1 Release Mechanisms 1 and 2 – Groundwater Releases	9-12
9.3.2 Release Mechanism 3 – Trench Overflow	9-14
9.3.3 Release Mechanism 4 – Trench Wall Breach-Solids Releases	9-14
9.3.4 Release Mechanism 4 – Trench Wall Breach-Water Releases	9-16
9.3.5 Release Mechanism 5 – Trench Cap Breach-Airborne Release	9-17
9.3.6 Release Summary	9-21
9.3.7 References	9-21
10 TRANSPORT ANALYSES	10-1
10.1 Watershed Parameters	10-2
10.2 Stream Modeling	10-2
10.3 Precipitation Events	10-5
10.4 Solids Transport	10-5
10.5 Modeling Results	10-8
10.5.1 Stream Flows	10-8
10.5.2 Liquid Transport	10-8
10.5.3 Solids Transport	10-9
10.6 References	10-11
11 DOSE ANALYSIS	11-1
11.1 Introduction	11-1
11.1.1 Consequence Endpoint	11-1
11.1.2 Site Administrative Controls and Operations	11-1
11.1.3 Transport Pathways	11-2
11.1.4 Locations and Characteristics of Receptors	11-2
11.2 Site Model	11-2
11.3 Dose Assessment Methodology	11-4
11.4 Methodology Implementation	11-7
11.5 Results	11-10
11.5.1 Releases of Trench Water	11-10
11.5.2 Releases of Trench Solids to Streams	11-12
11.5.3 Releases of Trench Solids to Air	11-14
11.6 Additional Parameters	11-15
11.7 References	11-16

TABLE OF CONTENTS (continued)

Section	Page
12 SCENARIO QUANTIFICATION	12-1
12.1 Risk from Liquid Releases	12-1
12.2 Risk from Solids Releases	12-3
12.3 Risk from Airborne Releases	12-5
12.4 References	12-6
13 SUMMARY OF RESULTS	13-1
13.1 Risk from the SDA	13-1
13.1.1 SDA Risk Curves and their Interpretation	13-1
13.1.2 Conclusions and General Observations	13-3
13.2 Summary of Risk Contributors	13-13
13.2.1 Scenario 1 – 2	13-13
13.2.2 Scenario 4 – 1c	13-15
13.2.3 Scenario 4 – 1	13-17
13.2.4 Scenario 2 – 1	13-18
13.2.5 Scenario 1 – 3	13-19
13.2.6 Scenario 3 – 4	13-20
13.2.7 Scenario 1 – 4	13-23
13.2.8 Scenario 1 – 1	13-25
13.2.9 Scenario 3 – 3	13-26
13.2.10 Additional Risk Contributors	13-29
13.3 Understanding the Uncertainties	13-52
14 CONCLUSIONS AND RECOMMENDATIONS	14-1
14.1 Conclusions	14-1
14.2 Recommendations	14-2
15 PUBLIC COMMENTS AND REVIEWS	15-1
15.1 Criticality	15-1
15.2 Terrorism	15-1
15.3 Climate Change	15-4
15.3.1 Historic Weather Data	15-4
15.3.2 Sensitivity Analyses	15-5

TABLES

Table	Page
4-1 Trench Liquid and Solid Waste Volumes	4-7
4-2 SDA Radionuclide Inventories	4-8
4A-1 SDA Trench 1 Radionuclide Inventory	4-13
4A-2 SDA Trench 2 Radionuclide Inventory	4-17
4A-3 SDA Trench 3 Radionuclide Inventory	4-21
4A-4 SDA Trench 4 Radionuclide Inventory	4-25
4A-5 SDA Trench 5 Radionuclide Inventory	4-29
4A-6 SDA Trench 6 Radionuclide Inventory	4-33
4A-7 SDA Trench 7 Radionuclide Inventory	4-39
4A-8 SDA Trench 8 Radionuclide Inventory	4-43
4A-9 SDA Trench 9 Radionuclide Inventory	4-47
4A-10 SDA Trench 10 Radionuclide Inventory	4-51
4A-11 SDA Trench 11 Radionuclide Inventory	4-55
4A-12 SDA Trench 12 Radionuclide Inventory	4-59
4A-13 SDA Trench 13 Radionuclide Inventory	4-63
4A-14 SDA Trench 14 Radionuclide Inventory	4-67
5.1-1 Potential SDA Threats	5-16
5.1-2 Threats Included in the SDA Risk Assessment	5-19
5.1-3 SDA Fissile Nuclide Inventories	5-20
5.1-4 Distribution of U-235 in SDA Trench 4	5-23
5.2-1 Historic Maximum Total Precipitation	5-31
5.2-2 Parameters for SDA QRA 24-Hour Precipitation Exceedance Curves	5-32
5.2-3 Parameters for SDA QRA 48-Hour Precipitation Exceedance Curves	5-33
5.2-4 Parameters for SDA QRA 3-Day Precipitation Exceedance Curves	5-34
5.2-5 Parameters for SDA QRA 7-Day Precipitation Exceedance Curves	5-35
5.2-6 Parameters for SDA QRA 14-Day Precipitation Exceedance Curves	5-36
5.3-1 Historic Maximum Wind Speeds	5-57
5.3-2 Parameters for SDA QRA High Wind Exceedance Curves	5-58
5.4-1 Tornado Events in 50-Mile Radius of West Valley Site, 1950-2006	5-66
5.4-2 Fujita Tornado Intensity Scale	5-71
5.4-3 Bayesian Analysis Results for Tornado Touchdown Frequency per Unit Area	5-72
5.4-4 Distribution for Tornado Intensity F0 Effective Impact Area	5-73
5.4-5 Distribution for Tornado Intensity F1 Effective Impact Area	5-74
5.4-6 Distribution for Tornado Intensity F2 Effective Impact Area	5-76
5.4-7 Distribution for Tornado intensity F3 Effective Impact Area	5-77
5.4-8 Distribution for Tornado Intensity F4 Effective Impact Area	5-78
5.4-9 SDA Tornado Impact Frequencies	5-79
5.5-1 Parameters for Modified URS Seismic Hazard Curves	5-84
5.5-2 Parameters for Modified USGS Seismic Hazard Curves	5-86
5.5-3 Parameters for SDA QRA Composite Seismic Hazard Curves	5-88
5.6-1 Airports and Airfields within 50 Miles of West Valley Site	5-110
5.6-2 Air Traffic Control Corridors in Vicinity of West Valley Site	5-112
5.7-1 SDA Meteorite Impact Frequencies	5-116
5.8-1 Wildfire Ignition Frequency Estimates	5-128
5.8-2 Estimated Distribution of Wildfire Sizes	5-129

TABLES (continued)

Table	Page
5.8-3 Effective Damage Area for SDA Analyses	5-130
6.2-1 SDA Soil Properties for Slope Stability Analyses	6-39
6.2-2 Probability Weights for Slope Model Input Parameters	6-40
6.2-3 SDA North Slope Seismic Failure Results	6-41
6.2-4 SDA East Slope (North End) Seismic Failure Results	6-45
6.2-5 SDA East Slope (South End) Seismic Failure Results	6-47
6.2-6 Correlation of North Slope and East Slope Failures	6-49
6.2-7 Seismic Slope Failure Fragilities for SDA Risk Models	6-50
6.3-1 Probability Assigned to Physical Condition Variations	6-65
6.3-2 Factors of Safety that a Failure Plane (Slip Circle) will Occur	6-66
6.3-3 Probabilities that a Failure Plane (Slip Circle) will Occur	6-67
6.3-4 Probability of Slope Failure at SDA within 30 Years	6-68
6.3-5 Probability of Trench Interception by Landslides within 30 Years (Assuming no Gully or Seismic Impacts)	6-69
6.3-6 Slope Stability Computation Results for Non-Seismic Conditions	6-70
6.3-7 Adjusted Slope Failure Likelihoods within 30 Years	6-72
6.3-8 Failure Surface Trench Intersections, from Seismic Analyses	6-74
6.3-9 Updated Failure Surface Trench Intersections	6-75
6.4-1 Summary of Trench Characteristics	6-91
6.4-2 Gully Headcuts Parallel to Trenches	6-92
6.4-3 Rills Incision Perpendicular to Trenches	6-93
6.4-4 Summary of Potential Gully Locations	6-94
6.4-5 Gullies Adjacent to the SDA	6-95
6.4-6 Gully Intersection with SDA Trenches	6-96
6.6-1 Total Fluid Release Volumes in SDA Trenches	6-144
6.6-2 Required Precipitation to Fill Trenches	6-145
6.7-1 Trench Reference Levels	6-173
6.7-2 Trench Levels and Precipitation, Years Before Geomembranes Installed	6-174
6.7-3 46-Day Precipitation Exceedance	6-181
6.7-4 56-Day Precipitation Exceedance	6-182
6.7-5 75-Day Precipitation Exceedance	6-184
6.7-6 91-Day Precipitation Exceedance	6-186
6.7-7 112-Day Precipitation Exceedance	6-188
6.7-8 150-Day Precipitation Exceedance	6-190
6.7-9 196-Day Precipitation Exceedance	6-192
6.7-10 252-Day Precipitation Exceedance	6-195
6.7-11 356-Day Precipitation Exceedance	6-198
7.2-1 Geomembrane Damage Threat Frequencies	7-21
7.2-2 Geomembrane Unavailability Results	7-22
7.3-1 Composite Trench Cap Erosion Fragilities	7-27
8.2-1 Scenarios for Release Mechanism 1	8-18
8.3-1 Scenario for Release Mechanism 2	8-22
8.4-1 Scenarios for Release Mechanism 3	8-46
8.5-1 Scenarios for Release Mechanism 4	8-58
9.2-1 Trench Radionuclide Inventory, Ci, Total (less Trenches 6 and 7) and by Trench	9-8

TABLES (continued)

Table	Page
9.2-2 Summary of Trench Water Concentration Measurement Results, pCi/L	9-9
9.2-3 Kd Values for Trench Water Nuclide Concentration	9-10
9.2-4 Trench Water Nuclide Concentration Calculation	9-11
9.3-1 Trench Solids Nuclide Concentrations, Ci/g	9-22
9.3-2 Summary of Release Category Data	9-23
10.5-1 Stream Flow Determined by HEC-HMS	10-12
10.5-2 Solids Combined by Releases from Direct Trench Wall Breach	10-13
10.5-3 Typical HEC-RAS Model Result – Sediment Deposition	10-14
12-1 SDA Risk Scenario Quantification Parameters	12-7
13.2-1 SDA Risk Scenarios	13-30
13.2-2 Geomembrane Unavailability, Trench Caps Intact, Quantification Parameter GEOMUI	13-33
13.2-3 Geomembrane Unavailability, Clay Caps Damaged, Quantification Parameter GEOMUD	13-34
15.3-1 Maximum 24-Hour Precipitation	15-12
15.3-2 Climate Change Sensitivity Analysis Results	15-13

FIGURES

Figure	Page
2-1	2-4
2-2	2-5
2-3	2-6
4-1	4-10
4-2	4-11
5.2-1	5-37
5.2-2	5-38
5.2-3	5-39
5.2-4	5-40
5.2-5	5-41
5.2-6	5-42
5.2-7	5-43
5.2-8	5-44
5.2-9	5-45
5.2-10	5-46
5.2-11	5-47
5.2-12	5-48
5.2-13	5-49
5.2-14	5-50
5.2-15	5-51
5.3-1	5-59
5.3-2	5-60
5.3-3	5-61
5.5-1	5-90
5.5-2	5-91
5.5-3	5-92
5.5-4	5-93
5.7-1	5-117
5.7-2	5-118
5.7-3	5-119
5.7-4	5-120
6.1A-1	6-24
6.1A-2	6-25
6.2-1	6-52
6.2-2	6-53
6.2-3	6-54
6.2-4	6-55

FIGURES (continued)

Figure	Page
6.3-1 Example Results from Modified-Bishop Slope Stability Analyses for Rotational Landslides	6-76
6.4-1 Conceptual Framework for the Gully Headcut Erosion through the Clay Cap	6-97
6.4-2 Fragility Curves Derived for Gully Headcuts Occurring along the Top (parallel to) the Trenches	6-98
6.4-3 Conceptual Framework for the Rill Erosion of the Clay Cap	6-99
6.4-4 Fragility Curves Derived for >1-m of Rill Incision Occurring along the Trenches Side-Slopes	6-100
6.4-5 Scaled Drawing of Actively Migrating Headcut Scour Hole	6-101
6.4-6 Postulated Gully Erosion Locations along the Eastern Portion of the SDA	6-102
6.4-7 Postulated Gully Erosion Locations along the Northwestern Portion of the SDA	6-103
6.4-8 Fragility Curves Derived for Actively Migrating Gullies from the Surrounding Areas of the SDA to Intersect the SDA Boundaries	6-104
6.4-9 Fragility Curves for Actively Migrating Gullies from the Surrounding Areas to Intersect the SDA Trenches, Geomembrane Covers Not Intact, Derived by QRA Team	6-105
6.6-1 Schematic Representation of Trench Fluid Fill Elevations	6-146
6.7-1 46-Day Precipitation Exceedance Curves	6-202
6.7-2 56-Day Precipitation Exceedance Curves	6-203
6.7-3 75-Day Precipitation Exceedance Curves	6-204
6.7-4 91-Day Precipitation Exceedance Curves	6-205
6.7-5 112-Day Precipitation Exceedance Curves	6-206
6.7-6 150-Day Precipitation Exceedance Curves	6-207
6.7-7 196-Day Precipitation Exceedance Curves	6-208
6.7-8 252-Day Precipitation Exceedance Curves	6-209
6.7-9 356-Day Precipitation Exceedance Curves	6-210
7.1-1 Surface Water Sampling Points	7-9
7.2-1 SDA Trenches	7-23
7.2-2 Geomembrane Covers	7-24
8.1-1 Functional Framework of SDA Risk Assessment Models	8-6
8.4-1 Release Mechanism 3 Scenario Logic	8-47
8.4-2 Buttermilk Creek Flow Correlation	8-48
8.7-1 Damaging Events without Correlated Precipitation	8-65
8.7-2 Damaging Events with Correlated Precipitation	8-66
8.7-3 Precipitation without Correlated Damage	8-67
10.1-1 Buttermilk Creek Basin Topographic Map	10-15
13.1-1 SDA Risk Curves, Exceedance Frequency Format	13-5
13.1-2 Release Frequency for Exceeding a Dose of 0.1 mrem in 1 Year, Probability Density Format	13-6
13.1-3 Release Frequency for Exceeding a Dose of 100 mrem in 1 Year, Probability Density Format	13-7
13.1-4 Uncertainty in Dose for Release Frequency of 1.0E-03 Event per Year, Probability Density Format	13-8
13.1-5 SDA Risk Curves, Exceedance Frequency Format (Expanded Scale)	13-9

FIGURES (continued)

Figure	Page
13.1-6 SDA Risk Curves, 30-Year Operation Period Exceedance Format	13-10
13.1-7 SDA Risk Curves, 30-Year Operation Period Exceedance Format (Expanded Scale)	13-11
13.1-8 Releases in SDA 30-Year Operation Period with Doses that Exceed 100 mrem in One Year	13-12
13.2-1 Uncertainty in Conditional Dose from Releases during Scenario 1 – 2	13-35
13.2-2 Uncertainty in Groundwater Releases during Scenario 1 – 2	13-36
13.2-3 Uncertainty in Frequency of Localized Landslides and Seismic Damage Condition 1	13-37
13.2-4 Uncertainty in Conditional Dose from Releases during Scenario 4 – 1c	13-38
13.2-5 Uncertainty in Conditional Dose from Releases during Scenario 4 – 1	13-39
13.2-6 Uncertainty in Conditional Dose from Releases during Scenario 2 – 1	13-40
13.2-7 Uncertainty in Groundwater Releases during Scenario 2 – 1	13-41
13.2-8 Uncertainty in Conditional Dose from Releases during Scenario 1 – 3	13-42
13.2-9 Uncertainty in Groundwater Releases during Scenario 1 – 3	13-43
13.2-10 Uncertainty in Exceedance Frequency for 9 inches Precipitation in 14 Days, Parameter IPRE9	13-44
13.2-11 Uncertainty in Conditional Dose from Releases during Scenario 3 – 4	13-45
13.2-12 Uncertainty in Conditional Dose from Releases during Scenario 1 – 4	13-46
13.2-13 Uncertainty in Groundwater Releases during Scenario 1 – 4	13-47
13.2-14 Uncertainty in Conditional Dose from Releases during Scenario 1 – 1	13-48
13.2-15 Uncertainty in Groundwater Releases during Scenario 1 – 1	13-49
13.2-16 Uncertainty in Exceedance Frequency for 1 inch Precipitation in 14 Days, Parameter IPRE1	13-50
13.2-17 Uncertainty in Conditional Dose from Releases during Scenario 3 – 3	13-51
15.3-1 Annual Precipitation Data	15-16

EXECUTIVE SUMMARY

The New York State Energy Research and Development Authority (NYSERDA) manages a 15-acre low-level radioactive waste disposal area, known as the "State-Licensed Disposal Area" (SDA), located at the Western New York Nuclear Service Center (Center) in western New York State. The U.S. Department of Energy (DOE) currently manages 179 acres of the Center for the West Valley Demonstration Project (WVDP), including the approximately 8-acre "NRC-Licensed Disposal Area" (NDA). NYSERDA also manages the balance of the 3,300-acre Center property.

The Final Environmental Impact Statement for decommissioning of the Center is being prepared jointly by DOE and NYSERDA. In the Draft Environmental Impact Statement (DEIS), NYSERDA's preferred alternative was to manage the SDA in place for "up to 30 years" with ongoing monitoring, inspections, maintenance, and analyses. On the recommendation of an Independent Expert Review Team (IERT), NYSERDA made the decision to conduct a quantitative risk assessment (QRA) to evaluate the radiation risks to the public over a 30-year time period. This report documents the QRA, its supporting models, data, and analyses, and the SDA risk assessment results.

After considering public comments on the DEIS, NYSERDA is assessing whether the duration of in-place management can be reduced. If the time period is reduced to less than 30 years, this QRA, which addresses the impacts from a 30-year management period, will provide a conservative assessment of the integrated SDA risk from in-place management for that shorter time period.

THE QRA FRAMEWORK

The fundamental elements of the QRA process are (1) the "triplet" definition of risk (defined below) to serve as a general framework for the meaning of risk, (2) a scenario approach that clearly links initial (*initiating events or initial conditions*) and final states (*consequences*) with well defined intervening events and processes, (3) the representation of uncertainty by a probability distribution (*the probability of frequency concept*), (4) a definition of probability that measures the *credibility* of a hypothesis based on the supporting evidence, and (5) information processing rooted in the fundamental rules of logic.

The general framework for the QRA is the "set of triplets" definition of risk.

$$R = \{<S_i, L_i, X_i>_c,$$

In this format, the brackets denote "the set of", and the subscript c implies that the set is complete. The risk ("R") is a comprehensive answer to the following questions:

- "What can go wrong?" This question is answered by describing a structured, organized, and complete set of possible damage scenarios ("S").
- "What is the likelihood of each scenario?" This question is answered by performing detailed analyses of each risk scenario, using the best available data and engineering knowledge of

the relevant processes, and explicitly accounting for all sources of uncertainty that contribute to the scenario likelihood ("L").

- "What are the consequences?" This question is answered by systematically describing the possible end states for each risk scenario, such as different radiation dose levels that may be received by a member of the public ("X").

THE QRA SCOPE

This study evaluates the risk from continued operation of the SDA for the next 30 years with its current physical and administrative controls. The scope of this risk assessment is limited to quantification of the radiation dose received by a member of the public, represented by two potential receptors.

- A permanent resident farmer located near the confluence of Buttermilk Creek and Cattaraugus Creek
- A transient recreational hiker / hunter who traverses areas along Buttermilk Creek and the lower reaches of Frank's Creek

The study evaluates potential releases of liquid, solid, and gaseous radioactive materials from the 14 waste trenches at the SDA site. It examines a broad spectrum of potential natural and human-caused conditions that may directly cause or contribute to these releases. Threats to the site are grouped into two general categories.

- **Disruptive Events** are unexpected events that cause an immediate change to the site. They are typically characterized by an event occurrence frequency and by directly measurable immediate consequences. Examples are severe storms, tornadoes, earthquakes, fires, and airplane crashes.
- **Nominal Events and Processes** are expected events and natural processes that evolve continuously over the life of the facility. They are typically characterized by a rate, which may be constant or changing over time. The potential consequences from these processes depend on the duration of the exposure period. Examples are groundwater flows, slope subsidence, and the aging of engineered and natural systems.

The QRA includes detailed models for the mobilization, transport, distribution, dilution, and deposition of released radioactive materials throughout the environment surrounding the SDA site, including the integrated watershed formed by Erdman Brook, Frank's Creek, and Buttermilk Creek.

This study does not present a quantitative evaluation of the risk from intentional acts of destruction, war, terrorism, or sabotage. Current risk assessment practices for most sensitive facilities in the United States, including nuclear power plants, do not include a quantitative analysis of the risk from these types of threats. Quantifying these risks would require the systematic evaluation of detailed threat scenarios for these sensitive facilities, which would present significant security concerns. While a quantitative assessment of the risk from acts of terrorism on the SDA was not developed for this study, the QRA team did perform limited

qualitative and simplified analyses of such threats to provide some insights on this issue (see Section 15.2).

EVALUATED THREATS

The scope of potential threats considered in this study includes a broad variety of natural phenomena and processes, and human-caused events. Systematic methods were used to examine and screen identified threats for their potential significance to the SDA risk. Table 1 lists the threats that were retained for explicit evaluation in the QRA models.

RELEASE MECHANISMS AND SCENARIOS

Five release mechanisms were defined to provide a framework and context for the risk scenarios. Each scenario begins with an initiating disruptive event or an evolving site process, and it results in a release of radioactive materials into the surrounding environment. It then continues through the mobilization and transport elements of the risk models, where the released materials are distributed, diluted, and deposited throughout the area surrounding the site. The scenario finally terminates in a source of radiation exposure and dose to the study receptors.

The five SDA release mechanisms are:

- **Release Mechanism 1** involves liquid releases from the waste trenches via groundwater flows through the Unweathered Lavery Till (ULT) and Kent Recessional Sequence (KRS) soil layers. Four risk scenarios were evaluated for this release mechanism.
- **Release Mechanism 2** involves liquid releases from the waste trenches via groundwater flows through the Weathered Lavery Till (WLT) soil layer. One risk scenario was evaluated for this release mechanism.
- **Release Mechanism 3** involves liquid overflows of the waste trenches and releases via surface water runoff. Nine risk scenarios were evaluated for this release mechanism.
- **Release Mechanism 4** involves physical breaches of the waste trenches and releases of liquid and solid radioactive materials. Sixteen risk scenarios were evaluated for this release mechanism.
- **Release Mechanism 5** involves extensive physical disruption of the SDA site and airborne releases from the waste trenches. One risk scenario was evaluated for this release mechanism.

SUPPORTING ANALYSES

Detailed analyses were performed to quantify the frequencies of all threats that are analyzed in the QRA models. In most cases, extensive effort was required to supplement the limited available information and data from previous assessments, to perform a realistic evaluation of the threat frequencies and their associated uncertainties.

Several "fragility analyses" were performed to quantify the conditional likelihood that a disruptive event or natural process will cause a release of radioactive materials from the SDA waste trenches. Members of the IERT provided technical guidance and input for a number of these analyses, developed some of the analytical models, and performed some of the detailed quantifications. The fragility analyses evaluated the following technical issues.

- Seismic failures of the slopes adjacent to the SDA site
- Failures of the slopes due to landslides that are not related to seismic events or erosion
- Erosion of the waste trench caps
- Erosion and migration of slope gullies
- Groundwater flows through lateral and vertical release pathways
- Trench filling and overflows from water intrusion

NYSERDA engineers provided evaluations of potential intervention efforts to stop or mitigate the consequences of specific radioactive material release scenarios. Analyses were also performed to quantify the effects from conditions that may require extensive repairs or replacement of the geomembranes.

Comprehensive inventories of the SDA waste materials were compiled from existing databases, including the distribution of specific radionuclides at 50-foot intervals in each trench. This information was used to quantify the physical form, quantity, and radioisotopic content of the materials that are released during each risk scenario.

Geohydrologic models were developed for the area surrounding the SDA site, including the integrated drainage basin for Erdman Brook, Frank's Creek, and Buttermilk Creek. These models were used to quantify flows and dilution of radioactive liquids that are released into the stream systems, the transport of solids, and the deposition of contaminated material in stream bed sediments. An atmospheric dispersion model was used to quantify flows, transport, and dilution of radioactive aerosols released into the air.

Analyses were performed to evaluate the exposure of each receptor to contaminants that are released during each risk scenario, accounting for the specific form of the material (e.g., liquid, solid, or airborne), its quantity and concentration at the point of exposure, and its radioisotopic content. Potential doses accrue from direct exposure to contaminated creek water, sediments, and airborne species. The analyses also assume that creek water is used for crop irrigation and livestock water supplies, resulting in additional potential doses through these food chain pathways. Creek water is not currently used as a domestic potable water supply for the local residents, and it is assumed that this practice will continue over the next 30 years. The total effective dose equivalent (TEDE) for each receptor is quantified in terms of millirem (mrem) accumulated in a 1-year period, for comparison with public health standards and other sources of radiation risk.

A preliminary draft of the QRA report was made available for public review and comments in October 2008. In parallel, the QRA team also used their insights and results from the draft study to identify a number of technical issues that warranted more detailed examination and refinement. The current version of the QRA benefits substantially from this evolution of the SDA risk assessment process. In particular, it accounts for the following enhancements of the 2008 models and supporting analyses.

- More comprehensive analyses of conditions that may cause water to enter the SDA trenches, and refinement of the corresponding trench water level probabilities.
- More comprehensive evaluation of NYSERDA programs for Buttermilk Creek water sampling to detect potential liquid activity releases.
- Improved quantification of uncertainties about radionuclide concentrations in the SDA trench soils and liquids.
- Improved correlations among regional weather data, incident precipitation, trench overflow fluid volumes, and flow rates in the adjacent streams.
- Assessment of specific issues that were raised during public reviews of the 2008 draft study.

THE SDA RISK

Figure 1 shows the integrated risk curves for the SDA site, in the "frequency of exceedance" format that is typically used to display QRA results. The following examples illustrate how these curves are interpreted.

- **Frequency of Dose Exceeding 0.1 mrem in 1 Year**

This result is obtained by taking a vertical "slice" through Figure 1 at the dose value of $1.0E-01$ mrem in 1 year. Figure 2 shows that "slice", in the "probability density" format that displays the calculated uncertainty about the frequency of this dose level.

The mean total frequency of all threats that cause radioactive material releases from the SDA site which result in a total effective dose to all receptors of 0.1 mrem in 1 year, or more, is approximately $7.0E-03$ event per year (i.e., one event in 145 years). There is equal probability that the release frequency for this dose is greater than, or less than, the median value of approximately $6.6E-03$ event per year (i.e., one event in 150 years). We are 90% confident that the release frequency is between $6.4E-03$ event per year and $7.8E-03$ event per year (i.e., between one event in 155 years and one event in 130 years). Since the mean value is the "expected" frequency of these releases, we do not "expect" to have a release that results in a dose of 0.1 mrem in 1 year, or more, during the next 30 years of SDA operation. However, Figure 2 shows that the long low-probability "tail" of the uncertainty distribution extends far beyond the 95th probability percentile. The full uncertainty results include approximately 1% probability that the frequency of these releases may exceed $3.2E-02$ event per year. Thus, a complete accounting for the uncertainty in the risk curves concludes that there is approximately 1% probability that this type of release could occur during the next 30 years.

- **Frequency of Dose Exceeding 100 mrem in 1 Year**

This result is similarly obtained by taking a vertical "slice" through Figure 1 at the dose value of $1.0E+02$ mrem in 1 year. Figure 3 shows that "slice".

The mean total frequency of all threats that cause radioactive material releases from the SDA site which result in a total effective dose to all receptors of 100 mrem in 1 year, or more, is

approximately $5.1E-04$ event per year (i.e., one event in 2,000 years). There is equal probability that the release frequency for this dose is greater than, or less than, the median value of approximately $4.8E-04$ event per year (i.e., one event in 2,100 years). We are 90% confident that the release frequency is between $3.9E-04$ event per year and $6.4E-04$ event per year (i.e., between one event in 2,600 years and one event in 1,600 years). The QRA results confirm that a release which results in a dose of 100 mrem in 1 year, or more, is extremely unlikely during the next 30 years of SDA operation.

Figure 4 is another representation of the SDA risk results, with an expanded scale that focuses on the dose range from 10 to 1000 mrem in 1 year. It displays the risk in terms of the number of release events that occur during the SDA 30-year operating period that is covered by this study. It is obtained by multiplying the frequency scale in Figure 1 by 30 years. The maximum value of the y-axis scale corresponds to 1 event that results in a release of radioactive material from the SDA during the next 30 years. Figure 4 clearly shows that it is very unlikely that a release will occur during the next 30 years with the consequences of a 1-year dose of 100 mrem, or more. For example, the 95th probability percentile in Figure 4 at the 100-mrem vertical "slice" is a factor of approximately 50 times lower than the once-in-30-year release value. This means that we are 95% confident that this type of release will occur much less often than once in 30 years. Figure 5 shows the complete uncertainty distribution for the "slice" at the 100 mrem dose level, further confirming the very high confidence in this conclusion.

Table 2 lists the mean ("expected") frequency of radioactive material releases for each risk scenario in terms of release events per year, the corresponding mean consequences from that scenario in terms of equivalent mrem dose in 1 year to all exposed receptors, and the product of the scenario frequency and consequences. This tabulation is useful to understand the detailed contributors to the overall SDA risk and their relative importance.

Only nine scenarios individually account for more than 1% of the total SDA risk, and these nine scenarios collectively account for almost 99% of the total. Each of the remaining 22 scenarios contributes less than 1% of the overall risk, and the 22 scenarios collectively account for just slightly more than 1% of the total. The top six scenarios for total SDA risk are:

- **Scenario 1 – 2** is the second scenario defined for Release Mechanism 1. It accounts for approximately 30% of the total SDA risk. The scenario involves lateral groundwater flows through the ULT soil layer. These releases occur when water levels in the waste trenches are at or near the interface between the ULT and WLT soil layers.
- **Scenario 4 – 1c** involves physical breaches of the waste trenches nearest to the East side and North end of the SDA. It accounts for approximately 23% of the total SDA risk. The trench breaches are caused by localized landslides or seismic events that destabilize the adjacent slopes. Scenario 4 – 1c evaluates the doses from liquid releases that occur when water levels in the waste trenches are at their current elevations, or lower.
- **Scenario 4 – 1** is similar to Scenario 4 – 1c. It also involves physical breaches of the waste trenches nearest to the East side and North end of the SDA that are caused by localized landslides or seismic events. It accounts for approximately 12% of the total SDA risk. Scenario 4 – 1 evaluates the doses from contaminated solids that are released from the damaged trenches.

- **Scenario 2 – 1** is the only scenario for Release Mechanism 2. It accounts for approximately 10% of the total SDA risk. The scenario involves lateral groundwater flows through the WLT soil layer near the surface of the SDA site. These releases can occur only when the water levels in the waste trenches are high, and the trenches are nearly full of water.
- **Scenario 1 – 3** is the third scenario defined for Release Mechanism 1. It accounts for approximately 7% of the total SDA risk. The scenario involves lateral groundwater flows through the ULT soil layer. These releases occur when water levels in the waste trenches are at their current elevations.
- **Scenario 3 – 4** is the fourth scenario defined for Release Mechanism 3. It accounts for approximately 6% of the total SDA risk. The scenario involves initial site conditions when the geomembranes are not intact, and the trench compacted clay caps are in their normal state. Water levels in the waste trenches are at or near the interface between the ULT and WLT soil layers. Total precipitation during a 14-day period exceeds 9 inches, including at least one storm with rainfall intensity that is severe enough to erode the trench caps and allow water intrusion to fill the trenches. The trenches overflow, and contaminated liquid enters the adjacent streams through surface runoff.

Table 2 shows that seismic damage, gully erosion, and landslide scenarios in Release Mechanism 4 contribute increasingly to the "low frequency / high consequence" end of the risk profile in Figure 1. The table shows that the mean doses from some of these scenarios can be quite significant. However, the release frequencies are extremely small, resulting in negligible contributions to overall site risk. "Intermediate frequency / intermediate consequence" scenarios in Release Mechanism 3 also contribute to the middle range of the risk spectrum.

The approximate fractional risk contribution from each major release mechanism is:

Release Mechanism 1: Groundwater flows through the Unweathered Lavery Till (ULT)	45%
Release Mechanism 2: Groundwater flows through the Weathered Lavery Till (WLT)	10%
Release Mechanism 3: Trench overflows and surface water runoff	9%
Release Mechanism 4: Trench breaches by erosion, landslides, and earthquakes	36%
Release Mechanism 5: Airborne releases from SDA physical impacts	<< 0.1%

CONCLUSIONS

The QRA results confirm that the public health risk from operating the SDA in its present configuration for the next 30 years is well below widely applied radiation dose limits, such as the 100 mrem per year limit specified under "Radiation Dose Limits for Individual Members of the Public" in Part 380 of the State of New York Codes, Rules, and Regulations (6 NYCRR Part 380) and in Part 20 of Title 10 of the Code of Federal Regulations (10CFR20). There is extremely high confidence that potential releases of radioactive materials from the SDA which may result in a 1-year dose to any member of the public of 100 mrem, or more, will occur much less often than once in 30 years.

These results should not be interpreted to mean that a release of this magnitude is impossible. They simply indicate that a release with these consequences is extremely unlikely during the next 30 years. If the SDA site could be maintained in its current state in perpetuity (including all

geohydrologic and meteorological conditions) we would expect to experience this type of event only once in approximately 2,000 years.

This low level of risk will be maintained only if NYSERDA continues to operate the SDA according to its current physical and administrative controls.

The quantified risk from the SDA is dominated by a small number of event scenarios. A total of nine scenarios accounts for almost 99% of the overall risk. Five of these scenarios involve releases of radioactive liquids from the waste trenches through groundwater flow paths. Two scenarios involve trench overtopping and radioactive liquid releases via surface runoff during heavy precipitation that occurs while the geomembranes are not intact. Two scenarios are caused by localized landslides or seismic events that result in partial breaching of waste trenches near the site boundaries, with subsequent releases of contaminated solids and liquids.

There is very large uncertainty about several of the most important risk contributors identified in this study. The three most significant sources of uncertainty are:

- Models and analyses for the groundwater release pathways. Substantial reduction of these uncertainties may be achieved by extensive refinements to the groundwater flow models, supporting data, and analyses.
- Estimation of radionuclide concentrations in the trench leachate. These uncertainties may be reduced by further refinements to the QRA evaluations of the distribution coefficients for liquid concentrations of the most risk-sensitive radionuclides. Additional sampling of the trench leachate may also reduce these uncertainties. However, each trench contains a small number of sample points, and large variability has been observed in previously measured nuclide concentrations. Therefore, limited benefit may be realized from additional sampling with the sole purpose to reduce uncertainties in the estimated average nuclide concentrations in the trench leachate. Nonetheless, consideration of periodic monitoring of trench leachate concentrations for this and other purposes, such as assessment of trench water turnover rates, may be warranted.
- Evaluation of SDA slope stabilities and non-seismic slope failures. It is likely that these uncertainties can be reduced through further refinements to the slope failure models and the trench intersection probabilities.

The first two sources of uncertainty have compound effects for the liquid release scenarios in Release Mechanisms 1 and 2. The second source of uncertainty also affects all other liquid release scenarios. The third source of uncertainty affects the most important risk contributors from Release Mechanism 4. Relatively small reductions in the uncertainties may have a rather significant impact on the quantified risk, due to the numerical effects from low probability "tails" of the uncertainty distributions.

RECOMMENDATIONS

Apart from decisions regarding possible refinements to the QRA models, data, and analyses, it is recommended that NYSERDA:

- Continue to monitor and, if necessary, actively maintain trench water levels below the ULT / WLT interface level, regardless of the status of the geomembranes and other activities at the site.
- Minimize the amount of time that the geomembrane covers are not intact, and the surface of the trench soil caps is exposed. This includes expedited repairs or replacement of damaged geomembrane sections, and minimizing the time and area of uncovered trench surfaces during planned geomembrane replacements.
- Formalize emergency preparedness plans and guidelines for responses to the types of release scenarios that are evaluated in this study. The risk from specific scenarios is affected significantly by the credit that has been applied for these intervention and mitigation responses.
- Consider the benefits from a program to periodically sample the water in each trench and monitor the concentrations of radionuclide species.

Table 1. Threats Included in the SDA Risk Assessment

Disruptive Events

- Aircraft Crashes
 - Commercial
 - General aviation
 - Military
- Erosion
 - Local streams
 - Trenches
- Extraterrestrial Impacts (meteorites)
- Fires
 - Offsite (e.g., grass fires, forest fires)
- Flooding Events
 - Extreme precipitation
 - Rapid snow melt
- High Wind Events
 - Extreme sustained winds
 - Wind gusts
 - Tornadoes
- Landslides
- Pipeline Accidents
 - Site natural gas supply pipe
- Seismic Events
 - Direct seismic failures
- Severe Storms (snow)

Nominal Events and Processes

- Corrosion / Deterioration / Decomposition
 - Geomembrane covers
 - Crates, boxes
 - Steel drums
- Groundwater Intrusion
 - Historic intrusion
 - Rapid intrusion ("bath-tubbing")
- Soil Shrink / Swell / Consolidation

Table 2. SDA Risk Scenarios (Page 1 of 3)

Scenario	Mean Frequency (event / year)	Mean Dose (mrem in 1 year)	Mean Frequency x Dose [(mrem in 1 year) / year]	Fraction of Total Risk	Cumulative Fraction of Total Risk	Contributing Conditions
1 – 2	4.57E-04	174.95	7.99E-02	2.97E-01	0.297	Groundwater, Level = ULT / WLT, ULT Lateral
4 – 1c	5.84E-05	1096.01	6.11E-02	2.27E-01	0.524	Local Landslide or Seismic Damage 1, Level = Current / Low, Liquids
4 – 1	5.93E-05	539.60	3.18E-02	1.18E-01	0.643	Local Landslide or Seismic Damage 1, Solids
2 – 1	4.00E-05	683.01	2.73E-02	1.02E-01	0.744	Groundwater, Level = High, WLT Lateral
1 – 3	3.12E-02	0.59	1.85E-02	6.88E-02	0.813	Groundwater, Level = Current, ULT Lateral
3 – 4	2.51E-04	69.66	1.73E-02	6.44E-02	0.877	Overflow, Level = ULT / WLT, > 9 inches in 14 days
1 – 4	3.33E-02	0.35	1.17E-02	4.36E-02	0.921	Groundwater, ULT-KRS
1 – 1	4.00E-05	290.64	1.16E-02	4.32E-02	0.964	Groundwater, Level = High, ULT Lateral
3 – 3	2.01E-05	294.57	5.44E-03	2.02E-02	0.985	Overflow, Level = High, Surface Disturbed, > 1 inch in 14 days
4 – 1b	8.13E-07	2283.36	1.77E-03	6.58E-03	0.991	Local Landslide or Seismic Damage 1, Level = WLT / ULT, Liquids
4 – 3c	8.65E-07	1187.35	1.17E-03	4.35E-03	0.995	Seismic Damage 2, Level = Current / Low, Liquids
4 – 1a	7.12E-08	4749.39	3.23E-04	1.20E-03	0.997	Local Landslide or Seismic Damage 1, Level = High, Liquids
4 – 3	8.79E-07	361.82	3.21E-04	1.19E-03	0.998	Seismic Damage 2, Solids

Table 2. SDA Risk Scenarios (Page 2 of 3)

Scenario	Mean Frequency (event / year)	Mean Dose (mrem in 1 year)	Mean Frequency x Dose [(mrem in 1 year) / year]	Fraction of Total Risk	Cumulative Fraction of Total Risk	Contributing Conditions
3 – 5	9.93E-07	171.28	1.67E-04	6.22E-04	0.999	Overflow, Level = ULT / WLT, Wind or Tornado, > 9 inches in 14 days
3 – 7	4.79E-06	34.78	1.49E-04	5.56E-04	0.999	Overflow, Level = Current / Low, > 25 inches in 14 days
4 – 2c	6.89E-08	1096.01	7.92E-05	2.95E-04	0.999	Gully Erosion, Level = Current / Low, Liquids
3 – 6	9.75E-07	69.46	6.23E-05	2.32E-04	1.000	Overflow, Level = ULT / WLT, Surface Disturbed, > 9 inches in 14 days
4 – 2	7.00E-08	539.60	3.81E-05	1.42E-04	1.000	Gully Erosion, Solids
4 – 3b	1.20E-08	2740.03	3.75E-05	1.40E-04	1.000	Seismic Damage 2, Level = WLT / ULT, Liquids
4 – 4c	4.95E-09	2557.37	1.35E-05	5.00E-05	1.000	Global Landslide, Level = Current / Low, Liquids
4 – 3a	1.05E-09	5662.74	6.79E-06	2.53E-05	1.000	Seismic Damage 2, Level = High, Liquids
5 – 1	3.69E-07	18.18	6.66E-06	2.48E-05	1.000	Aircraft crash or meteorite
3 – 2	1.97E-07	14.38	2.79E-06	1.04E-05	1.000	Overflow, Level = High, Wind or Tornado
4 – 2b	9.58E-10	2283.36	2.30E-06	8.54E-06	1.000	Gully Erosion, Level = WLT / ULT, Liquids
3 – 1	1.99E-08	28.60	6.32E-07	2.35E-06	1.000	Overflow, Level = High, 24- or 48-Hour Storm
3 – 9	2.07E-08	34.78	5.57E-07	2.07E-06	1.000	Overflow, Level = Current / Low, Surface Disturbed, > 25 inches in 14 days

Table 2. SDA Risk Scenarios (Page 3 of 3)

Scenario	Mean Frequency (event / year)	Mean Dose (mrem in 1 year)	Mean Frequency x Dose [(mrem in 1 year) / year]	Fraction of Total Risk	Cumulative Fraction of Total Risk	Contributing Conditions
3 – 8	1.93E-08	34.78	5.33E-07	1.98E-06	1.000	Overflow, Level = Current / Low, Wind or Tornado, > 25 inches in 14 days
4 – 4b	6.89E-11	6028.08	4.41E-07	1.64E-06	1.000	Global Landslide, Level = WLT / ULT, Liquids
4 – 2a	8.39E-11	4749.39	4.18E-07	1.56E-06	1.000	Gully Erosion, Level = High, Liquids
4 – 4	5.03E-09	24.95	1.17E-07	4.34E-07	1.000	Global Landslide, Solids
4 – 4a	6.03E-12	9772.79	6.26E-08	2.33E-07	1.000	Global Landslide, Level = High, Liquids

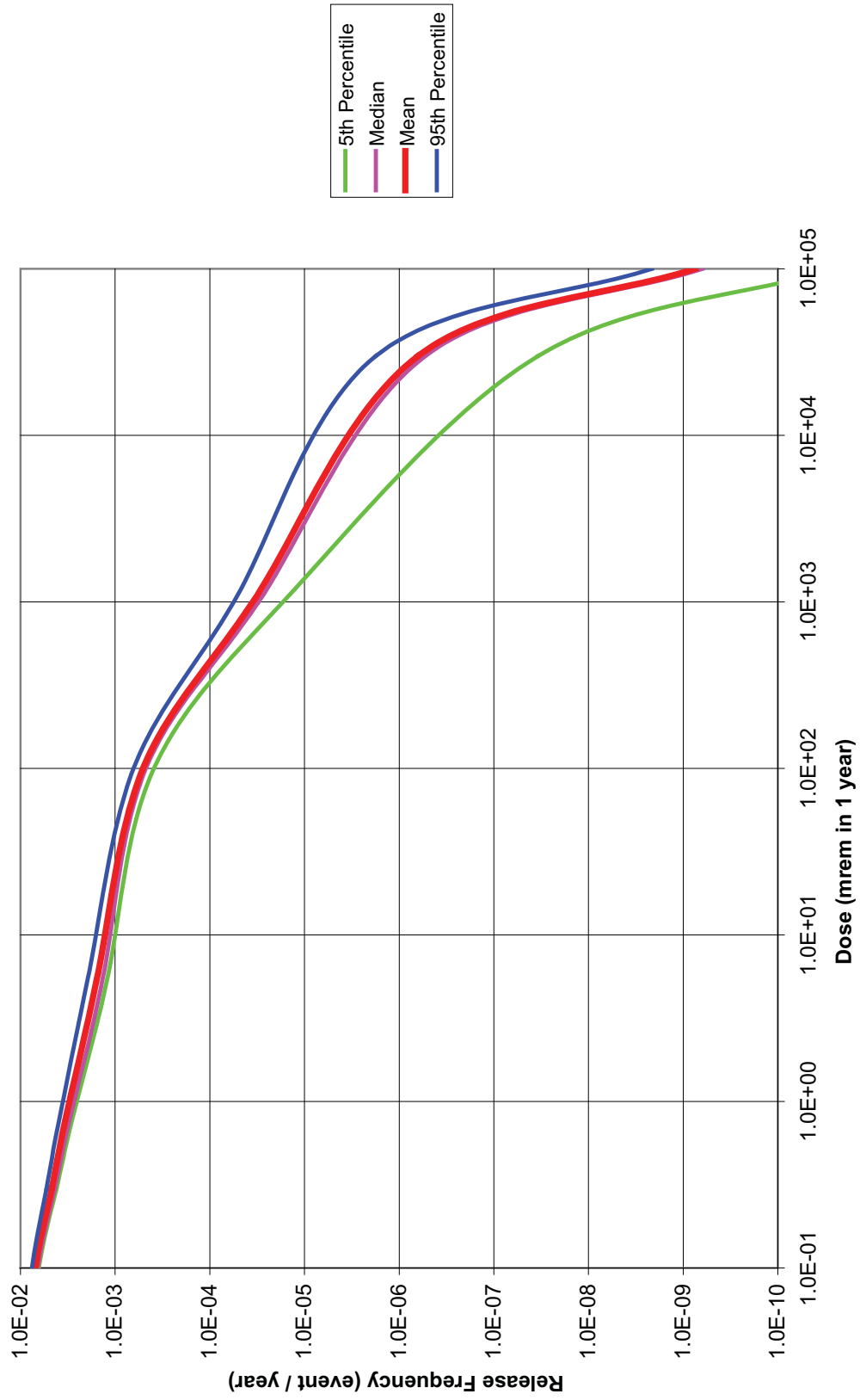

Figure 1. SDA Risk Curves, Exceedance Frequency Format

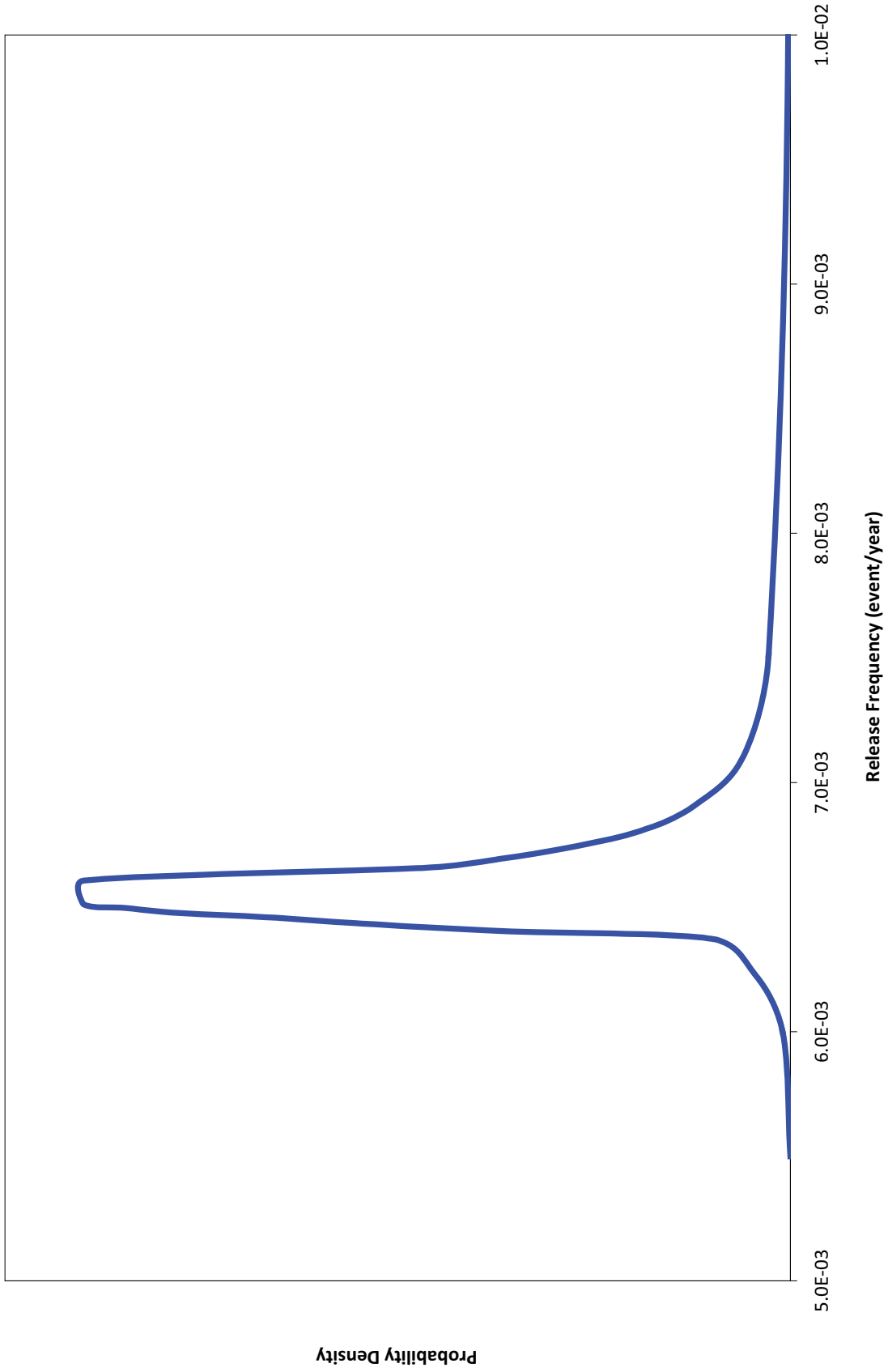

Figure 2. Release Frequency for Exceeding a Dose of 0.1 mrem in 1 Year, Probability Density Format

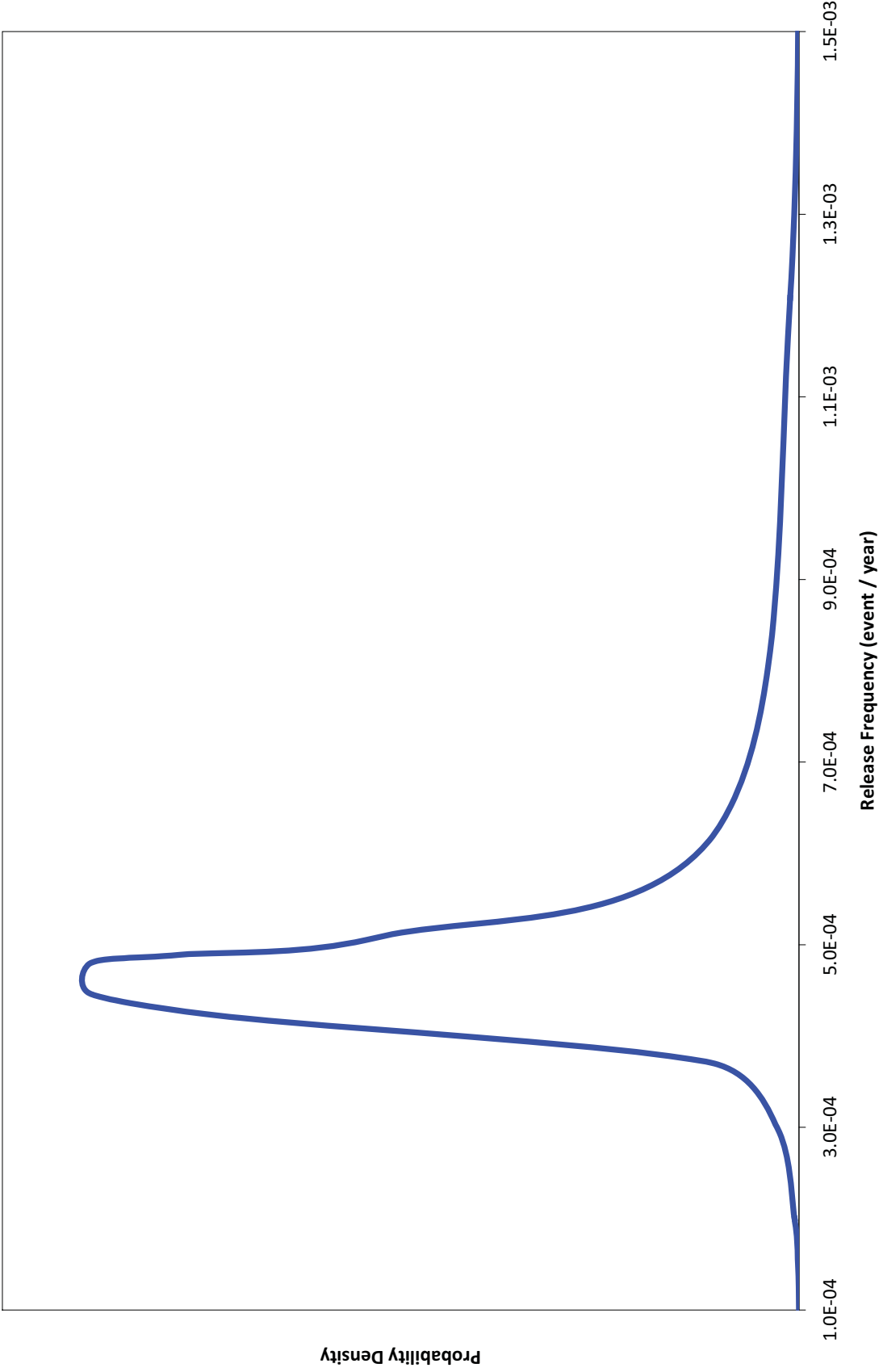

Figure 3. Release Frequency for Exceeding a Dose of 100 mrem in 1 Year, Probability Density Format

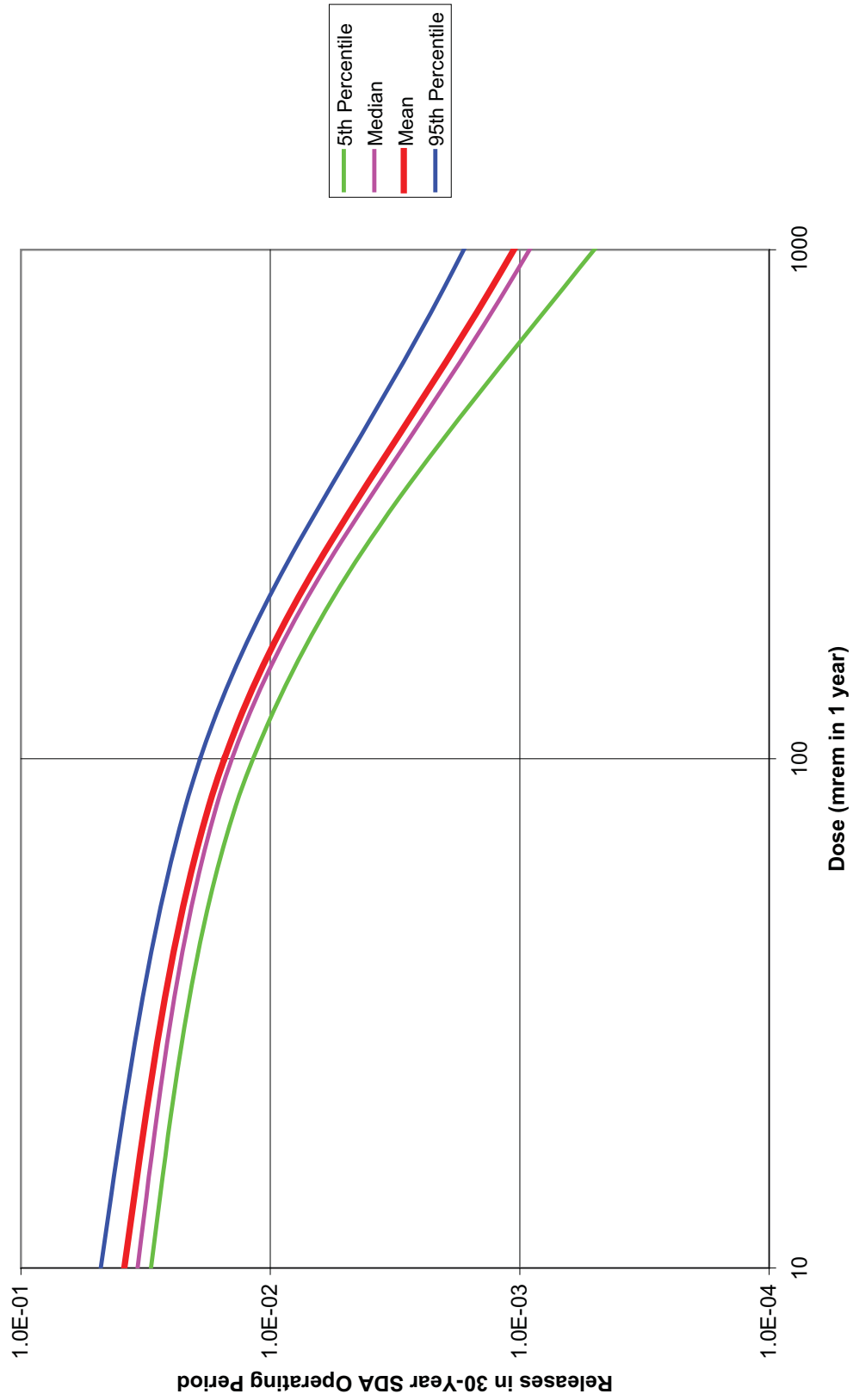

Figure 4. SDA Risk Curves, 30-Year Operation Period Exceedance Format (Expanded Scale)

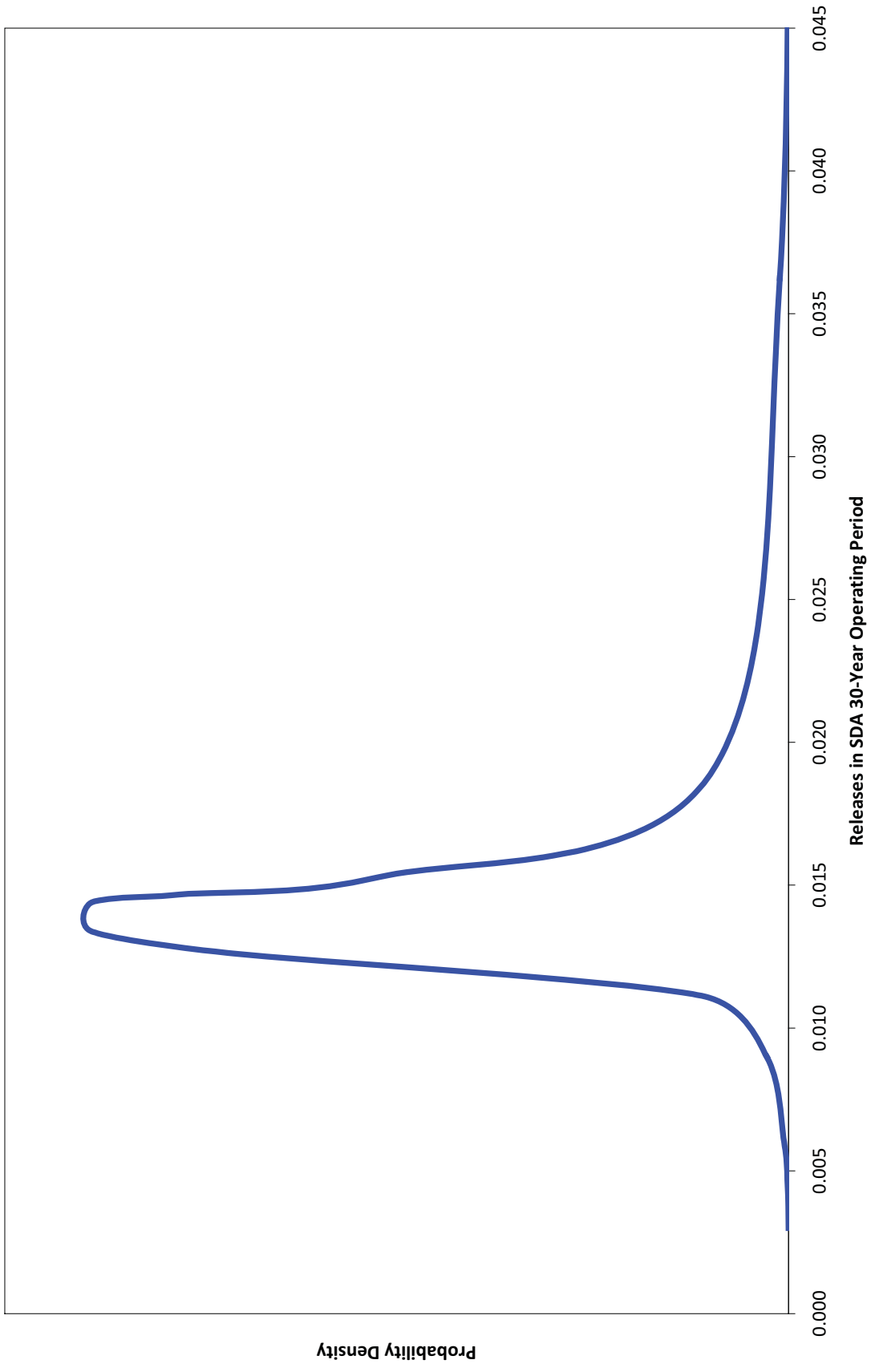

Figure 5. Releases in SDA 30-Year Operation Period with Doses that Exceed 100 mrem in 1 Year

SECTION 1

BACKGROUND AND INTRODUCTION

The New York State Energy Research and Development Authority (NYSERDA) manages a 15-acre low level radioactive waste disposal area at the Western New York Nuclear Service Center (Center) in western New York State. The Center is the location of a commercial nuclear fuel reprocessing plant that was operated by Nuclear Fuel Services, Inc., from 1966 to 1972. NYSERDA is the current owner of the facility. In 1980, the United States Congress passed the West Valley Demonstration Project (WVDP) Act. The Act directed the U.S. Department of Energy (DOE) to carry out a high level radioactive waste demonstration project at the complex, in accordance with requirements prescribed by the U.S. Nuclear Regulatory Commission (NRC). DOE currently manages 179 acres of the Center for the WVDP, including the approximately 8-acre "NRC-Licensed Disposal Area" (NDA). NYSERDA manages the 15-acre "State-Licensed Disposal Area" (SDA), a commercial radioactive waste disposal facility that operated from 1963 to 1975. NYSERDA also manages the balance of the 3,300-acre Center property.

Decommissioning criteria for the WVDP are contained in the NRC Policy Statement on Decommissioning Criteria for the West Valley Demonstration Project. Long-term performance of the SDA will be examined in the Final Environmental Impact Statement for decommissioning of the Center that is being prepared jointly by DOE and NYSERDA. In the Draft Environmental Impact Statement (DEIS), NYSERDA's preferred alternative was to manage the SDA in place for "up to 30 years" with ongoing monitoring, inspections, maintenance, and analyses. On the recommendation of a subgroup of the Independent Expert Review Team (IERT), NYSERDA made the decision to conduct a quantitative risk assessment (QRA) to evaluate the radiation risks to the public over a 30-year time period.

The recommendation to conduct this assessment was based on a scoping analysis performed by three members of the IERT (Reference 1-1). The primary purposes of the initial scoping analysis were to develop general guidance on the scope and to obtain preliminary insights about potential results from a more comprehensive quantitative risk assessment. Some key observations from the scoping analysis are as follows.

- Nominal events and processes are not likely to result in scenarios that represent a significant radiation risk to members of the public under the chosen conditions for the SDA QRA. Inspection and maintenance of the geomembrane cover will keep infiltration of water into the trenches at a low level. Transport of radionuclides through the clay in the Unweathered Lavery Till (ULT) is believed to be slow, and significant quantities of radionuclides are not expected to travel 20 meters or more to reach the more transmissive sands of the Kent Recessional Sequence (KRS) within 30 years. Lateral transport through the Kent Recessional Sequence is expected to be slow, and only a small fraction of radionuclides that might reach the sequence is believed to transport laterally to surface water drainages. Transport in surface water, should it occur, would be rapid for some species.
- Disruptive events and processes are believed to result in the scenarios that would dominate the radiation risk to the public of the SDA. Disruptive events include unlikely human actions and extreme natural events. Consequences associated with deliberate sabotage or

catastrophic inadvertent disruption (e.g., as a result of an airplane crash directly impacting the SDA) are potentially large, but the probability of occurrence of such events is believed to be extremely low. This category of scenarios is not expected to be a significant contributor to total risk.

- Consequences associated with extreme natural events have the potential to be relatively large. The largest offsite risks will probably be associated with rapid erosion during single storm events that expose portions of the SDA trenches to direct transport in surface water. Uncertainty in the risk will be dominated by uncertainty in the frequency of such events and uncertainty in the amount of waste material exposed to surface water transport. Quantification of both of these parameters will likely be based on informed expert judgment, and uncertainty will remain large.
- Other potentially significant scenarios involving extreme natural events are believed to have either lesser consequences than the single-event storm erosion scenario (e.g., flooding of the trenches and overflow may be more likely, but consequences appear to be less) or less likely (e.g., ground-motion induced slumping). Combinations of extreme events are much less likely (the joint probability of a combination of two events is the product of the individual probabilities), and consequences do not appear to be sufficiently greater to cause an increase in risk.

Outside experts were retained by the IERT Chairman with the concurrence of NYSERDA to complete the risk analysis team. The IERT Chairman served as the SDA QRA study director. The QRA study team used the scoping analysis as a general framework to develop a systematic and more comprehensive assessment of the SDA risk and its contributors. The draft risk study was completed in an intense effort between late May and early September 2008. Due to the very restricted time and resources, several supporting analyses were necessarily simplified. The study team made every effort to ensure that all analyses are fully documented and traceable, that simplifications include appropriate conservatism while retaining sound technical justification, and that important sources of uncertainty are described and quantified.

The draft QRA results confirmed several of the preliminary scoping study conclusions. However, the more comprehensive and systematic QRA analyses identified several contributing scenarios that were not fully anticipated by the simplified assessment. The draft QRA report was made available for public review and comments in October 2008. In parallel, the QRA team also used their insights and results from the draft study to identify a number of technical issues that warranted more detailed examination and refinement.

The current version of the QRA benefits substantially from this evolution of the SDA risk assessment process. In particular, it accounts for the following enhancements of the 2008 models and supporting analyses.

- More comprehensive analyses of conditions that may cause water to enter the SDA trenches, and refinement of the corresponding trench water level probabilities. The updated analyses evaluate specific causes for removal of the geomembranes, and quantify the corresponding frequencies and durations. Regional weather data are also used to derive estimates for the likelihood of precipitation events that may cause the trenches to fill.
- More comprehensive evaluation of NYSERDA programs for Buttermilk Creek water sampling to detect potential liquid activity releases.

- Improved quantification of uncertainties about radionuclide concentrations in the SDA trench soils and liquids.
- Improved correlations among regional weather data, incident precipitation, trench overflow fluid volumes, and flow rates in the adjacent streams.
- Assessment of specific issues that were raised during public reviews of the 2008 draft study.

After considering public comments on the DEIS, NYSERDA is assessing whether the duration of in-place management can be reduced. If the time period is reduced to less than 30 years, this QRA, which addresses the impacts from a 30-year management period, will provide a conservative assessment of the integrated SDA risk from in-place management for that shorter time period.

Section 2 of this report provides an overview of the QRA methodology, and Section 3 summarizes the scope of the study. Section 4 describes the SDA and key site features that affect the QRA models and results. Section 5 lists the disruptive events and natural processes that were examined as potential threats to the SDA, including screening assessments of their potential risk significance and quantitative analyses of those retained for explicit evaluation. Section 6 documents focused analyses performed by the QRA team and members of the IERT to quantify the likelihood that specific threats will cause a release of radioactive materials from the SDA. Section 7 describes the analyses of natural and engineered barriers that confine the waste material or protect it against specific threats, and potential intervention and mitigation measures if a release occurs. Section 8 describes the QRA analytical framework and derivation of the specific release scenarios that are quantified in the models. Section 9 summarizes supporting analyses that were performed to characterize the physical form, quantity, and radioisotopic content of the released materials. Section 10 describes the models and analyses that evaluate distribution, dilution, and deposition of contaminated liquids and solids throughout the environment between the SDA site and potential receptor locations. Section 11 summarizes the analyses that were performed to quantify radiation doses to members of the public who may be exposed to the released materials. Section 12 describes how the QRA models were quantified. Section 13 summarizes the results of the study, including the quantified risk, its contributors, and associated uncertainties. Section 14 highlights the major study conclusions and recommendations. Section 15 discusses specific issues and topics of interest that arose during public reviews of the draft 2008 study.

1.1 REFERENCES

- 1-1. "Scoping Analysis of a Quantitative Risk Assessment of the State Operated Low Level Radioactive Waste Disposal Area", Garrick, B. J., P. N. Swift, and C. G. Whipple, March 2008

SECTION 2

QRA METHODOLOGY

The elements of quantitative risk assessment applied to assessing the radiation risk to the public of the SDA are (1) the "triplet" definition of risk (defined below) to serve as a general framework for the meaning of risk, (2) a scenario approach that clearly links initial (*initiating events or initial conditions*) and final states (*consequences*) with well defined intervening events and processes, (3) the representation of uncertainty by a probability distribution (*the probability of frequency concept*), (4) a definition of probability that measures the *credibility* of a hypothesis based on the supporting evidence, and (5) information processing rooted in the fundamental rules of logic.

The general framework for the QRA is the "set of triplets" definition of risk, which has its roots in References 2-1 and 2-2. That definition is,

$$R = \{ \langle S_i, L_i, X_i \rangle \}_c,$$

where "R" denotes the risk—in this case the risk of a member of the public receiving different radiation dose levels, S_i denotes the i th risk scenario (a description of something that can go wrong), L_i denotes the likelihood of that scenario happening in the *probability of frequency* format, and X_i denotes the consequences of that scenario if it does happen, which in this case will take the form of the radiation dose to a member of the public. The angle brackets $\langle \rangle$ enclose the risk triplets, the curly brackets $\{ \}$ are math speak for "the set of", and the subscript c denotes "complete", meaning that all, or at least all of the important scenarios, must be included in the set.

The first question is answered by describing a structured, organized, and complete set of possible "what can go wrong" scenarios.

The second question requires the calculation of the "likelihoods", L_i , of each of the scenarios, S_i . The interpretation of likelihood for the SDA QRA is the "probability of frequency" format, where frequency of the undesired event is the risk measure. A probability curve over the frequency axis is then developed to communicate the uncertainty in the frequency of the undesired event. Probability is defined as a number varying between 0 and 1 indicating the credibility of a hypothesis based on the totality of the supporting evidence.

The third question is answered by describing the "damage states" or "end states" (denoted X_i) resulting from these risk scenarios. For the SDA QRA, these states measure different radiation dose levels that may be received by a member of the public.

With the triplet definition as the basic framework for the SDA QRA, the actual process for conducting the QRA is based on Reference 2-3 and involves the following steps, (1) define the SDA in terms of what constitutes successful operation, to serve as a reference point for abnormal operations, (2) identify and characterize the sources of danger (the hazard), which for the SDA are the radionuclides that could contribute to a radiation dose to a member of the public, (3) develop "what can go wrong" scenarios to establish radionuclide release rates and consequences, (4) quantify the likelihoods of the different scenarios and their contribution to the radiation dose based on the relevant evidence, (5) assemble the radiation dose scenarios into

the appropriate risk curves and risk priorities, and (6) interpret the results to guide the risk management process.

The core effort of a QRA is structuring and quantifying the frequency, ϕ , of scenarios, S . A systematic assessment of the evolution and structure of complex scenarios is often facilitated by a logic diagram known as an *event tree*, the form of which is illustrated in Figure 2-1.

An event tree is a diagram that traces the response of a system to an initiating event (or initial condition), such as a severe storm, to different possible end points or outcomes (consequences). A single path through the event tree is a "scenario" or an "event sequence". The event tree displays the role of engineered and natural systems, and other features and processes in determining the course of the "what can go wrong" scenarios and their ultimate consequences. In Figure 2-1, the boxes with the letters A, B, C, and D represent these intervening events, processes, and actions. The general convention is that if the defensive action is successful, the scenario is mitigated. If the action is unsuccessful, then the effect of the initiating event continues as a downward line from the branch point as shown in Figure 2-1. Probability distributions are developed for each of the branch points (or "split fractions"), the convolution of which leads to a probability distribution for the whole scenario.

Once the scenarios have been quantified, the results can be assembled into the forms of Figures 2-2 and 2-3. Figure 2-2 displays the risk of a specific consequence such as the risk of a member of the public receiving a specific radiation dose from all of the scenarios resulting in that specific dose. The total area under the curve represents a probability of 1. The fractional area between Φ_1 and Φ_2 represents the confidence, that is, the probability that Φ has values over that interval. Figure 2-3 is the more classic risk curve as it portrays the risk of varying consequences. Figure 2-3 is known as the "frequency of exceedance" curve or the "complementary cumulative distribution function".

To illustrate how to read Figure 2-3, suppose P_3 has the value of 0.95, that is a probability of 0.95, and suppose we want to know the risk of an X_1 consequence at the 95% confidence level. According to the figure, we are 95% confident that the frequency of an X_1 consequence or greater is Φ_2 . The family of curves (usually called percentiles) can include as many curves as necessary. The ones most often selected in practice are the 5th, 50th, and 95th percentiles. A popular fourth choice is the mean.

An often used method of communicating uncertainty in the risk of an event is to present the risk in terms of a confidence interval. If the area between Φ_1 and Φ_2 of Figure 2-2 is 90% of the area under the curve, the way to read this result is we are 90% confident (the 90% confidence interval) that the frequency range is between Φ_1 and Φ_2 . To illustrate how to read Figure 2-3 in terms of a confidence interval, let P_1 have the value of 0.05, P_3 the value 0.95, Φ_1 the value of one in 10,000, Φ_2 one in 1,000, and X_1 the value of 100 mrem. Given that P_3 minus P_1 is 0.90, the proper language would be that we are 90% confident that the frequency of a 100 mrem consequence or greater varies from once every 10,000 years to as much as once every 1,000 years.

Although risk measures such as those illustrated in Figures 2-2 and 2-3 answer the question of "what is the risk" and how much confidence we have in the results, they are not necessarily the most important output of the QRA. The most important output is the systematic, transparent identification of the contributors to the risk in the process of getting to Figures 2-2 and 2-3. Figures 2-2 and 2-3 then provide the basis for ranking the importance of those contributors and identifying corrective actions that provide the greatest return to mitigate and control the risk.

2.1 REFERENCES

- 2-1. "Unified Systems Safety Analysis for Nuclear Power Plants", Garrick, B. J., PhD thesis, University of California, Los Angeles, 1968
- 2-2. "On the Quantitative Definition of Risk", Kaplan, S., and B. J. Garrick, *Risk Analysis*, 1(1): 11-27, 1981
- 2-3 **Quantifying and Controlling Catastrophic Risks**, Garrick, B. J., et al., Elsevier, Amsterdam, 2008

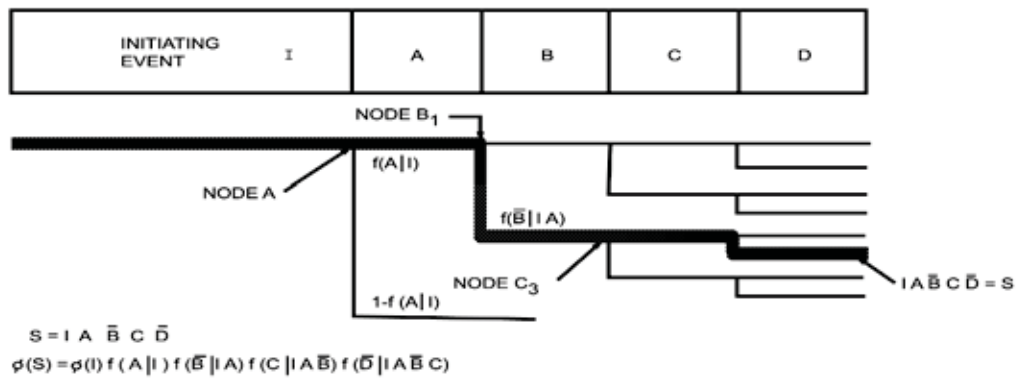

Figure 2-1. Event Tree Representation of Risk Scenarios

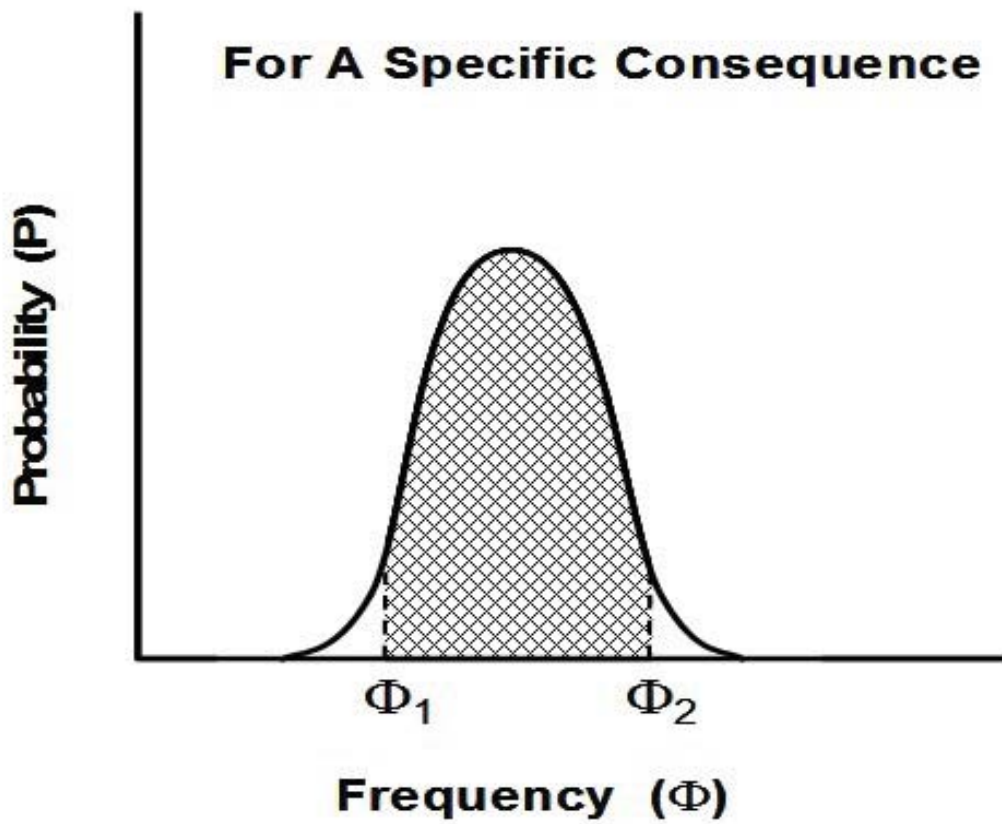

Figure 2-2. Probability Density

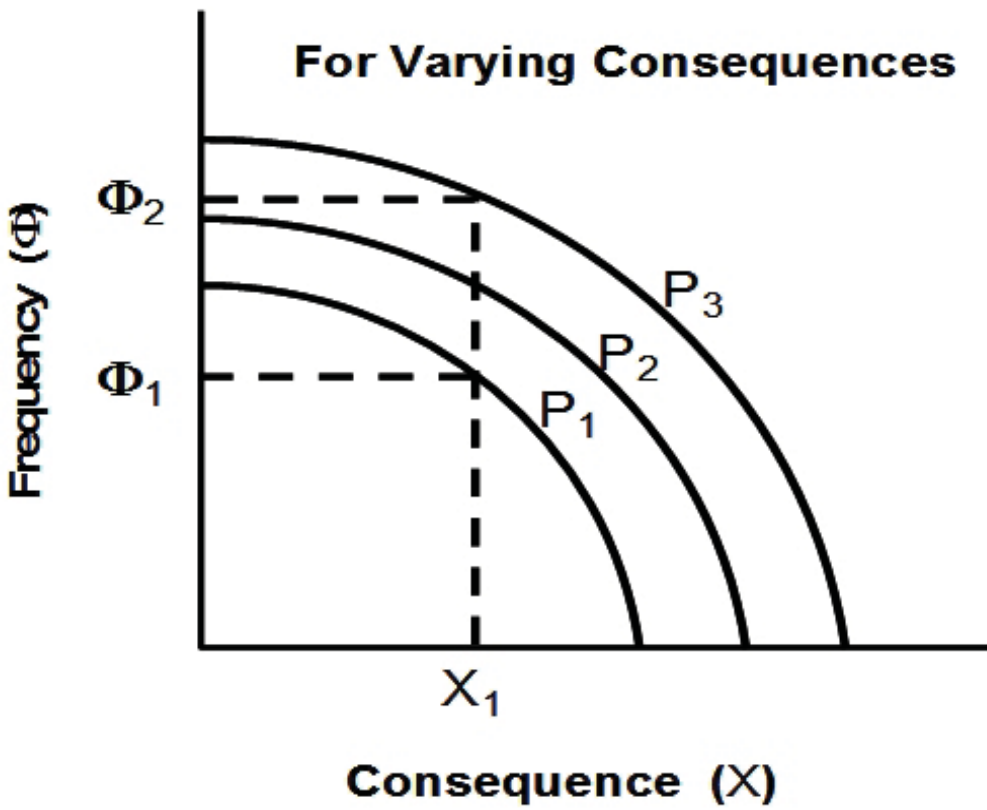

Figure 2-3. Cumulative Probability

SECTION 3

QRA SCOPE

This study evaluates the risk from continued operation of the SDA for the next 30 years with its current physical and administrative controls.

3.1 DEFINITION OF RISK

The scope of this risk assessment is limited to quantification of the radiation dose received by a member of the public. Radiation exposures to onsite facility workers and risks from exposures to hazardous and toxic chemicals are not evaluated in this study. Hazardous and toxic chemical impacts are being evaluated as part of the Corrective Measure Study for the SDA, being conducted under a RCRA Section 3008(h) Administrative Order on Consent.

The radiation dose to be calculated is the total effective dose equivalent (TEDE). For purposes of assessing doses to members of the public, TEDE means the sum of the effective dose equivalent (for external exposures) and the committed effective dose equivalent (for internal exposures). The effective dose equivalent is the sum of the products of the dose equivalent to the organ or tissue and the weighting factors applicable to each of the body organs or tissues that are irradiated. The committed effective dose equivalent is the sum of the products of the weighting factors applicable to each of the body organs or tissues that are irradiated and the committed dose equivalent to these organs or tissues. The committed dose equivalent is the dose equivalent that is committed to specific organs or tissues that will be received from an intake of radioactive material by an individual during the 50 years following the intake.

This study does not address potential financial or administrative risks that may be associated with continued operation of the SDA for the next 30 years.

3.2 LOCATIONS AND CHARACTERISTICS OF RECEPTORS

This study evaluates potential radiation doses to two receptors.

One receptor is a permanent resident farmer, located near the confluence of Buttermilk Creek and Cattaraugus Creek. Potential doses to this receptor accrue from direct exposure to contaminated creek water and sediments. It is also assumed that creek water is used exclusively for crop irrigation and livestock water supplies, resulting in additional potential doses through these food chain pathways. The farm currently obtains all domestic potable water from an underground spring. It is very unlikely that the farm would extract water from the creek for drinking or other domestic uses during the next 30 years, due to the difficulty and expense required to purify the water for human consumption. Therefore, direct ingestion of creek water is not evaluated as a potential dose pathway over the 30-year study period.

The second receptor is a transient recreational hiker / hunter who traverses areas along Buttermilk Creek and the lower reaches of Frank's Creek. The range of this receptor extends within the West Valley site property boundaries, but does not enter the fenced portion of the site. Potential radiation doses to this receptor accrue from exposure to contaminated creek water and sediments.

Since the duration of this study is within the period of continued SDA institutional controls, public intrusion within the fenced area of the site and alternate uses of the SDA land area are not included in the assessment.

3.3 TRANSPORT PATHWAYS

This study evaluates potential releases of liquid, solid, and gaseous radioactive materials from the SDA site. The analyses account for distribution, dilution, and deposition of liquid and solid contaminants throughout the interconnected watershed formed by Erdman Brook, Frank's Creek, and Buttermilk Creek. Water flows through the stream systems during the next 30 years are based on the current configurations of the creek channels and valley walls, including downstream flows through Cattaraugus Creek and upstream tributaries. Stream flow rates are based on historically measured values and regional weather data.

3.4 LOCATIONS AND TYPES OF RADIATION HAZARDS

The SDA currently contains four general sources of potential radiation hazards.

- Radioactive solid waste material that is buried in the 14 trenches
- Radioactive liquid in the trenches, containing contaminants leached from the wastes
- Residual contaminated soils below three drained lagoons
- Radioactive trench leachate that is stored in onsite tanks

The waste trenches are back-filled with soil and covered by compacted clay soil caps. The volumes, physical forms, and radionuclide contents of the waste materials are based on the best available documented inventories, at a level of detail that covers 50-foot intervals in each trench.

The Northern Filled Lagoon was drained in 1975, and the Southern Filled Lagoon was drained in 1977. These former lagoons are located in the North Disposal Area, and they are now filled with a combination of vermiculite and native soil. The Inactive Filled Lagoon is located in the South Disposal Area. It was drained in 1991, lined with a geomembrane, and is now filled with native soil. Current estimates indicate that soils below these former lagoons are contaminated to a depth of approximately 30 feet below the SDA ground surface.

The waste trenches and all three abandoned lagoons are covered by sealed geomembranes, with an engineered stormwater drainage system. The risk assessment includes potential releases of radioactively contaminated liquid, solid, and gaseous materials from all portions of the SDA site currently covered by the geomembranes.

Three radioactive liquid storage tanks are located inside two small buildings at the west side of the SDA. Two of the tanks, located in the Frac Tank Building, are currently empty and have never been used. One tank, located in the T1 Tank Building, currently contains approximately 8,000 gallons of untreated radioactive leachate that was pumped from Trench 14 in 1991. NYSERDA has indicated that this tank will be drained by 2010, and the liquid will be removed for offsite treatment and disposal. There are no current plans to use this tank for additional

liquid waste storage. Based on these near-term commitments and plans, this study does not evaluate potential releases from the liquid waste storage tanks.

3.5 SITE ADMINISTRATIVE CONTROLS AND OPERATIONS

Site operating processes, procedures, and technologies will be the same as those of today. Inspection, maintenance, monitoring, mitigation, and security activities in effect as of June 2008 will continue for the duration of the 30-year study period. Effectiveness of these activities is based on their present and past effectiveness. Evaluations of future planned activities that may affect the SDA during the next 30 years are based on the best available current information about the specific types of activities, their scopes, and schedules.

3.6 SCOPE OF ANALYZED THREATS

During the 30-year period of this study, a variety of natural and human-caused conditions may occur that have potential impacts on the SDA. These conditions are broadly characterized as "threats" to the SDA. Some threats may cause a direct release of radioactive materials from the waste trenches. Some conditions may alter the site in ways that increase its vulnerability to other threats. Potential conditions that may affect the site can be grouped into two general categories.

- **Disruptive Events.** These are unexpected events that may cause an immediate change to the site. They are typically characterized by an event occurrence frequency and by directly measurable immediate consequences. Examples are severe storms, tornadoes, earthquakes, fires, and airplane crashes.
- **Nominal Events and Processes.** These are expected events and processes that evolve continuously over the life of the facility. They are typically characterized by a rate, which may be constant or changing over time. The potential consequences from these processes depend on the duration of the exposure period. Examples are groundwater flows, slope subsidence, and the aging of engineered and natural systems.

Climate conditions during the 30-year period of this analysis are assumed to be unchanged from the present. Weather patterns, including severe storms and extreme events, are based on historical records from the region surrounding the site. Section 15.3 discusses the potential effects from postulated changes in the regional climate during the next 30 years.

This study does not present a quantitative evaluation of the risk from intentional acts of destruction, war, terrorism, or sabotage. Current risk assessment practices for most sensitive facilities in the United States, including nuclear power plants, do not include a quantitative analysis of the risk from these types of threats. Quantifying these risks would require the systematic evaluation of detailed threat scenarios for these sensitive facilities, which would present significant security concerns. Brief consideration was given to selecting a few "evident" intentional threats to demonstrate how these acts are treated within the overall risk assessment process. However, the QRA team was concerned that partial analyses might inadvertently imply that a "complete" assessment of deliberately aggressive acts had been performed, or that the selected acts would receive inappropriate attention as the "most important" potential contributors. Therefore, the team decided that the most appropriate decision was to exclude rigorous quantification of the risk from this class of threats from the current study. While a

quantitative assessment of the risk from acts of terrorism on the SDA was not developed for this study, the QRA team did perform limited qualitative and simplified analyses of such threats to provide some insights on this issue (see Section 15.2).

SECTION 4

DESCRIPTION OF THE STATE-LICENSED DISPOSAL AREA

The SDA (Figure 4-1) occupies approximately 15 acres of the Western New York Nuclear Service Center immediately adjacent to the West Valley Demonstration Project. It consists of two sets of parallel trenches that contain radioactive waste (Figure 4-2). Trenches 1 through 7 are located in the North Disposal Area, and Trenches 8 through 14 are located in the South Disposal Area. In addition to the waste trenches, the site contains three abandoned lagoons and two buildings that enclose three liquid waste storage tanks, only one of which has been used to store liquid waste.

Surrounded by an 8-foot-high chain-link fence, NYSERDA limits access to the SDA by controlling the issuance of keys to the five locked SDA gates. In addition, a contracted security service conducts routine patrols of the SDA perimeter.

4.1 HISTORY OF OPERATIONS

Between 1963 and 1975, Nuclear Fuel Services placed approximately 2.4 million cubic feet of radioactive waste in trenches constructed in the native silty-clay soil. The total waste inventory in the trenches includes 230 radionuclides having an estimated activity of 128,000 Curies. More details about the specific radionuclide inventories are provided in Section 4.3. The trenches, ranging from 450 to 650 feet in length, are approximately 20 feet deep. Trench cross-sections are trapezoidal in shape, with a top width of 35 feet and a bottom-floor width of 20 feet. During construction, the trench floors were sloped along their length to allow water to drain into a low point where a trench sump was located. A vertical pipe, which extends from above the trench cap to each sump, provides a way to routinely monitor trench water levels. The sump pipe also serves as a conduit through which water can be sampled or removed from the trenches.

Differing in both physical form and construction from other trenches, Trenches 6 and 7 were built to house high-activity wastes that required immediate shielding. Trench 6 is a series of 19 individual holes in which waste was placed, while Trench 7 is a narrow, shallow trench where waste containers were placed, then encased in concrete. Neither of these two trenches required installation of a sump.

Each trench is covered with an 8- to 10-foot-thick mounded cap of compacted clay, and a drainage swale is located between adjacent trenches to direct precipitation away from the trenches. Efforts to minimize erosion of the clay caps and infiltration of water into the trenches began in the late 1970s and early 1980s. These efforts included rolling and reseeding the trench caps as well as several larger-scale regrading, recapping, and water infiltration control projects.

The site also contains three abandoned lagoons, two in the North Disposal Area and one in the South Disposal Area. The Northern Filled Lagoon was originally used to store water pumped from the North Disposal Area trenches. It was drained in 1975 and filled with a combination of vermiculite and native soil. The Southern Filled Lagoon was originally used to store water pumped from the North Disposal Area trenches and the adjacent NDA Hardstand. It was drained in 1977 and filled with a combination of vermiculite and native soil. The Inactive Filled Lagoon was drained in 1991, lined with a geomembrane, and filled with native soil.

Rising water levels in Trenches 13 and 14 led NYSERDA to proactively investigate additional water management measures. In 1990, NYSERDA began implementing several projects aimed at reducing water accumulation in the SDA trenches. As a means to control the leachate, between 1990 and 1991, NYSERDA installed three tanks in two adjoining weather-tight buildings at the SDA. In 1991, 8,000 gallons of leachate were pumped from Trench 14 into a 9,200-gallon fiberglass tank, located in the smaller of the two buildings. The two tanks in the larger building have never been used.

In September 1992, NYSERDA installed a soil-bentonite subsurface barrier wall along the western side of Trench 14 to divert groundwater flow away from the south trenches (8 through 14). In June 1993, the project was completed with the installation of an exposed, very low-density polyethylene (VLDPE) geomembrane cover. The cover extends from the centerline of Trench 12, across Trenches 13 and 14, the Inactive Filled Lagoon, and the barrier wall, terminating in a stormwater drainage swale excavated just beyond the barrier wall. Perforated piping was placed on top of the geomembrane and the drainage swale was backfilled with stone. Slit-trench monitoring wells were also installed to monitor groundwater elevations on either side of the subsurface barrier wall. This project was conducted as an interim measure (IM) under the Resource Conservation and Recovery Act (RCRA) 3008(h) Administrative Order on Consent (Docket No. II RCRA-3008(h)92-0202) (Consent Order).

In 1995, NYSERDA expanded the use of geomembrane covers at the SDA with the installation of an exposed reinforced ethylene interpolymer alloy (XR-5) geomembrane cover over Trenches 1 through 8, Trenches 10 through 12, and the remaining filled lagoons. NYSERDA also installed a stormwater management system consisting of five XR-5-lined stormwater basins designed to detain and release precipitation without increasing peak runoff from pre-project conditions.

In the fall of 1999, NYSERDA installed a geomembrane cover on Trench 9, replacing a bioengineering management cover that was installed as a pilot project in September 1993.

NYSERDA maintains the SDA through routine inspections followed by prompt corrective actions, as needed. On November 23, 2005, NYSERDA submitted a notification of claim for the 6 NYCRR 374-1.9 storage and treatment conditional exemption for the low level mixed waste at the SDA. Under this conditional exemption, stored low level mixed waste in the tank must be inspected quarterly.

NYSERDA staff performs routine facility inspections, quarterly RCRA-facility inspections, and scheduled field walkovers of the SDA and the surrounding slopes. In addition, an annual inspection of the geomembrane cover is performed. All inspections are documented on standard forms, which are maintained as West Valley Site Management Program (WVSMP) records. Any deficiencies noted during these inspections are documented and tracked; corrective actions are scheduled, completed and closed out; and all actions are recorded in the maintenance log database.

A Corrective Measure Study under a RCRA Section 3008(h) Administrative Order on Consent was initiated in 2006 to evaluate potential corrective measures to address hazardous chemical constituents present in the disposal trenches. Other activities to assure the safety of the SDA include the establishment of an Erosion Peer Review Group consisting of both academic and government erosion experts to assist in the preparation of plans for erosion monitoring, control

and maintenance at the SDA, and the establishment of an Environmental Monitoring Program. The 2009 SDA Environmental Monitoring Program includes:

- Trench leachate elevation measurements
- Groundwater elevation measurements
- Groundwater sampling and analysis
- Surface water sampling and analysis
- Stormwater sampling and analysis
- Gamma radiation monitoring
- Ground surface elevation measurements

In addition to routine testing and preventive maintenance, NYSERDA completed the following maintenance activities in 2008:

- Stormwater Outfall W06 was eliminated and the drainage area re-graded to direct runoff into the collection system for Outfall W05
- Made small repairs to the geomembrane cover
- Replaced sections of the geomembrane cover's safety walkway
- Repaired lightning damage to the Tank T-1 Building leak detection alarm and a geomembrane boot near the south monument of Trench 14
- Repaired the rollup door on the north side of the Frac Tank Building

4.2 SITE GEOHYDROLOGY

The SDA is located in an area of the Center that is described as the South Plateau. The South Plateau area is incised by tributaries to Buttermilk Creek, the primary surface-water feature in the immediate area. The tributaries most significant to the SDA are Erdman Brook, which bounds the area on the north, and Frank's Creek, which bounds the area on the east and south. Constructed drainage features drain the area immediately west of the SDA into Frank's Creek or into Lagoon Road Creek, which drains into Erdman Brook. The drainage basins feeding Erdman Brook and Frank's Creek include much of the higher elevation area west of this portion of the Center. These streams, which merge at a confluence a short distance northeast of the SDA, flow as Frank's Creek to its confluence with Buttermilk Creek, 1.3 miles downstream from the SDA. Buttermilk Creek, in turn, flows 2.5 miles north to its confluence with Cattaraugus Creek. The confluence with Cattaraugus Creek approximately marks the northern boundary of the Center property.

The topography of much of the 15-acre SDA is relatively level, characterized by a series of aligned low ridges marking the capped disposal trenches. The maximum surface elevation is approximately 1,390 feet National Geodetic Vertical Datum (NGVD) on top of the trench caps. Topographic relief in the immediate area is between 45 and 55 feet, with the lowest elevation areas around the SDA occurring along the active channels of Erdman Brook and Frank's Creek. The surface elevation at the confluence of Erdman Brook and Frank's Creek is about 1,315 feet NGVD. The Buttermilk Creek channel elevation is about 1,180 feet NGVD at the confluence with Frank's Creek and about 1,110 feet NGVD at the confluence with Cattaraugus Creek.

The Center is located within the glaciated northern portion of the Appalachian Plateau physiographic province. The SDA is located on the west side of the Buttermilk Creek valley in an area referred to as a till plain. Subsurface materials beneath the SDA include a sequence of glacial (Pleistocene) deposits that is up to 500 feet thick overlying much older (Devonian)

bedrock. The glacial materials of most significance to the SDA include the Lavery and Kent tills. Directly beneath the SDA, these units are subdivided into a Weathered Lavery Till (WLT) unit, an Unweathered Lavery Till (ULT) unit, and the Kent Recessional Sequence (KRS). These units are generally described as follows.

- **Weathered Lavery Till.** Weathered glacial ice deposit, fractured and moderately porous till, primarily comprised of clay and silt, generally considered to occur from the ground surface to about 10 feet deep in the SDA area. Hydrogeologically, this unit displays a relatively wide range of hydraulic conductivity and effective porosity values because of the variance in its textural makeup and the presence of fracturing throughout the unit. Hydraulic conductivities associated with the WLT range from 1×10^{-5} to 1×10^{-8} meters / second (m/s), with associated effective porosities ranging from 0.001 to 0.32, the lower range values associated with fracturing.
- **Unweathered Lavery Till.** Glacial ice deposit, dense, compact and slightly porous clayey and silty till with some discontinuous sand lenses, generally considered to be between about 15 and 90 feet thick in the SDA area. Hydrogeologically, this unit is considered to have low-range hydraulic conductivities. Hydraulic conductivities associated with the ULT range from 1×10^{-5} to 1×10^{-11} m/s, with associated effective porosities ranging from 0.01 to 0.32, the lower range values associated with fracturing in the upper portion of the unit.
- **Kent Recessional Sequence.** Possible meltwater or lake deposit, gravel comprised of pebbles, small cobbles, and sand, and clay and clay-silt rhythmic layers overlying the Kent till. This unit generally is 40 feet thick in the SDA area. Hydrogeologically, this unit is considered to have medium-range hydraulic conductivities. Hydraulic conductivities associated with the KRS range from 1.0×10^{-6} to 5.5×10^{-9} m/s, with associated effective porosities ranging from 0.19 to 0.27.

Section 6.5.5.3 provides additional details about the sources and derivations of the soil hydraulic conductivities and effective porosities.

4.3 TRENCH DATA AND RADIONUCLIDE INVENTORIES

Table 4-1 summarizes the volumes of liquid leachate, solid waste material, and soil fill in each trench. These data were compiled for this study, based on the trench dimensions, waste volumes, and current liquid leachate levels (References 4-1 through 4-7). Trapezoidal cross-sections were used to compute the trench volumes, according to available descriptive information and the dimensions in Reference 4-4. The waste volumes in the table are derived from the integrated database compiled in Reference 4-2. The trench volume not occupied by waste was assumed to be occupied by soil. The fluid volumes are based on trench leachate levels measured in March 2008, as documented in Reference 4-7.

Extensive efforts have been made to identify and characterize the inventories of wastes that are buried in the 14 SDA trenches. The most comprehensive and detailed summary is documented in Reference 4-2, which is the primary source of radionuclide data for this study. Waste inventories in each trench are compiled at 50-foot intervals, based on available shipping and burial records. The total activity in each 50-foot interval is apportioned among 60 radionuclides, according to the quantities and types of buried material, the disposal time, and radioisotopic decay through the beginning of the year 2000. The analysis included no inventory correction for radioactive decay since the beginning of the year 2000. Scoping analyses indicated that decay correction to 2009 would result in only small dose reductions.

Appendix 4A reproduces the detailed trench radionuclide inventories from Reference 4-2. Table 4-2 is a more comprehensible subset of that list and includes the inventories of the 33 radionuclides that are potentially most important to public health risk from offsite releases. This list omits most short-lived nuclides formed as products of much longer-lived precursor nuclides. For dose assessment purposes, these nuclides are assumed to be present in equilibrium with precursor nuclides. The list also omits other nuclides unimportant to dose because of very short half-lives, very small inventories, etc.

Although Table 4-2 omits many nuclides tabulated in Appendix 4A, all of the nuclides listed in Appendix 4A, except for Kr-85, were included in the analysis. Kr-85 was omitted from the analysis because the SDA inventory of Kr-85 (about 72 curies) is too small to result in significant environmental radiation doses and because, being an inert gas, Kr-85 would be present in trench water or trench solids, the release materials of primary concern in this study, only in very low concentrations.

The summaries in Table 4-2 also exclude the inventories of wastes that are buried in the 19 special-purpose holes that comprise Trench 6 and the concrete-encapsulated wastes in Trench 7. Except for possible releases of any accumulated liquid leachate in those trenches, the solid wastes are essentially immobile for potential offsite releases. Therefore, this risk assessment is concerned primarily with the waste inventories in Trenches 1 through 5 in the North Disposal Area, and Trenches 8 through 14 in the South Disposal Area.

The study explicitly accounts for substantial uncertainties in the radionuclide concentrations in the trench soils and liquids, derived from the baseline data summarized in this section. Section 9.2 describes the quantification of those uncertainties and their application in the models for each risk scenario.

4.4 REFERENCES

- 4-1. "Draft Environmental Impact Statement for Decommissioning and/or Long-Term Stewardship at the West Valley Demonstration Project and Western New York Nuclear Service Center", DOE/EIS-0226-R, United States Department of Energy and New York State Energy Research and Development Authority, draft for internal review, 2008
- 4-2. "SDA Radiological Characterization Report", Wild, R. E., prepared for West Valley Nuclear Services Company, Inc., URS Corporation, 2002
- 4-3. "Screening Analysis of Remedial Technologies Potentially Applicable to the U.S. Nuclear Regulatory Commission-Licensed Disposal Area and the New York State-Licensed Disposal Area at the Western New York Nuclear Service Center", WSMS-WV-05-0006, Revision 0, Washington Safety Management Solutions, 2005
- 4-4. Trench design schematic drawing, supplied by NYSERDA, July 2008
- 4-5. "Estimated Weathered Till – Unweathered Till Interface" cross-section series, supplied by NYSERDA, July 2008
- 4-6. "Potential Leachate Level Changes after Installation of Geomembrane Cover at the New York State Licensed Low-Level Radioactive Waste Disposal Area (SDA) West Valley, New York", Dames and Moore, 1995

4-7. SDA Trench Leachate Level Measurements, 1986 – 2008, data supplied by NYSERDA, July 2008

Table 4-1. Trench Liquid and Solid Waste Volumes							
Trench	Trench Volume (cu. ft.)	Fluid Volume (cu. ft.)	Waste Volume (cu. ft.)	Waste Mass if density = 1.6 gm/cc (lbs)	Soil Fill Mass if density = 1.6 gm/cc (lbs)	Total Mass of Trench Fill (Waste + Soil) (lbs)	
1	1.94E+05	4.60E+03	5.24E+04	5.23E+06	1.41E+07	1.93E+07	
2	1.94E+05	1.17E+04	1.18E+05	1.18E+07	7.59E+06	1.93E+07	
3	3.85E+05	1.46E+04	2.02E+05	2.01E+07	1.84E+07	3.85E+07	
4	3.73E+05	1.81E+04	2.98E+05	2.98E+07	7.43E+06	3.72E+07	
5	3.31E+05	3.08E+04	2.59E+05	2.58E+07	7.24E+06	3.31E+07	
8	3.11E+05	2.13E+04	2.52E+05	2.52E+07	5.89E+06	3.11E+07	
9	3.09E+05	9.21E+03	1.74E+05	1.73E+07	1.36E+07	3.09E+07	
10	3.06E+05	2.79E+04	1.84E+05	1.84E+07	1.22E+07	3.05E+07	
11	3.06E+05	1.42E+04	1.84E+05	1.84E+07	1.21E+07	3.05E+07	
12	3.06E+05	1.92E+04	1.98E+05	1.97E+07	1.08E+07	3.05E+07	
13	3.37E+05	4.01E+04	2.09E+05	2.09E+07	1.27E+07	3.36E+07	
14	3.64E+05	3.30E+04	2.30E+05	2.29E+07	1.34E+07	3.63E+07	

Table 4-2. SDA Radionuclide Inventories (Primary Nuclides Only, from Reference 4-2) (Page 1 of 2)

Nuclide	Order	Half-Life (years)	Trench Inventory (Curies)				
			1	2	3	4	5
H-3	1	1.23E+01	8.68E+00	7.93E+01	9.07E+02	2.82E+03	3.75E+03
C-14	2	5.73E+03	2.74E+00	3.80E+00	1.21E+01	8.63E+01	2.48E+01
Fe-55	3	2.70E+00	1.45E-02	1.27E-01	1.76E-01	3.81E+00	7.02E+00
Co-60	4	5.27E+00	2.62E+00	1.90E+01	2.38E+01	2.79E+02	4.00E+02
Ni-59	5	7.49E+04	1.45E-01	1.20E+00	1.41E+00	5.09E+01	1.11E+02
Ni-63	6	1.00E+02	1.69E+01	3.64E+01	7.98E+01	1.59E+03	2.69E+03
Sr-90	8	2.86E+01	1.85E+00	4.08E+00	4.75E+00	5.53E+01	5.30E+00
Zr-93	10	1.53E+06	0	0	1.51E-07	5.20E-06	4.47E-06
Nb-94	11	2.03E+04	4.60E-03	3.80E-02	4.47E-02	2.28E-01	8.70E-02
Tc-99	12	2.13E+05	2.06E-02	6.79E-02	8.03E-02	6.80E-01	1.38E-01
I-129	13	1.57E+07	6.00E-02	1.86E-01	2.22E-01	1.91E+00	2.55E-01
Cs-135	14	2.30E+06	2.07E-02	6.91E-02	8.13E-02	6.62E-01	9.43E-02
Cs-137	15	3.01E+01	2.43E+02	8.00E+02	9.58E+02	8.12E+03	1.19E+03
Pm-147	17	2.62E+00	0	0	1.30E-06	7.14E-05	4.16E-03
Pb-210	20	2.22E+01	1.15E-01	1.39E-01	2.87E-01	1.10E+01	2.49E+00
Po-210	28	3.79E-01	1.14E-01	1.37E-01	2.84E-01	1.10E+01	2.48E+00
Ra-226	39	1.60E+03	1.71E-01	2.06E-01	4.31E-01	1.16E+01	2.77E+00
Ra-228	40	5.75E+00	6.17E-01	5.23E-03	7.18E-02	2.45E-02	6.06E-01
Ac-227	41	2.18E+01	3.17E-06	1.95E-06	9.74E-06	4.59E-01	9.41E-02
Th-228	44	1.91E+00	6.13E-01	5.20E-03	7.12E-02	2.44E-02	5.99E-01
Th-230	45	7.69E+04	5.16E-05	2.39E-05	1.97E-04	9.83E+00	2.02E+00
Th-232	47	1.40E+10	6.26E-01	5.31E-03	7.29E-02	2.50E-02	6.21E-01
Pa-231	49	3.27E+04	7.91E-06	4.88E-06	2.46E-05	4.60E-01	9.42E-02
U-233	51	1.59E+05	5.89E-10	1.05E-09	1.55E-06	5.31E-05	4.56E-05
U-234	52	2.44E+05	1.62E-01	7.47E-02	6.26E-01	3.41E+01	5.50E+00
U-235	53	7.03E+08	1.05E-02	6.49E-03	3.32E-02	1.37E+00	2.21E-01
U-238	54	4.46E+09	2.07E-02	7.56E-02	5.06E-01	5.92E+01	9.37E+00
Pu-238	55	8.77E+01	4.43E-01	9.18E-01	2.28E+00	3.18E+01	1.71E+02
Pu-239	56	2.41E+04	4.02E-01	1.84E+00	1.03E+01	3.11E+01	2.01E+01
Pu-240	57	6.56E+03	6.60E-04	1.65E-03	9.28E-01	9.32E+00	5.54E+00
Pu-241	58	1.44E+01	3.20E+00	6.01E+00	3.23E+01	3.98E+02	1.79E+02
Am-241	59	4.32E+02	8.56E-01	1.57E+00	5.44E+00	6.94E+01	2.30E+01
Cm-242	60	4.47E-01	0	0	1.91E-07	6.61E-06	5.71E-06
TOTAL			2.83E+02	9.55E+02	2.04E+03	1.37E+04	8.61E+03

Table 4-2. SDA Radionuclide Inventories (Primary Nuclides Only, from Reference 4-2) (Page 2 of 2)

Nuclide	Order	Trench Inventory (Curies)										Total
		8	9	10	11	12	13	14				
H-3	1	6.93E+03	3.89E+03	7.08E+03	8.64E+03	2.28E+03	1.43E+03	8.12E+02	3.86E+04			
C-14	2	2.08E+01	3.39E+01	4.12E+01	4.07E+01	2.11E+01	3.83E+00	6.95E+00	2.98E+02			
Fe-55	3	8.05E-01	3.62E-01	3.91E-02	3.83E-01	4.73E+00	2.37E-01	6.87E-01	1.84E+01			
Co-60	4	3.40E+01	2.76E+01	1.55E+01	2.04E+01	1.54E+02	3.59E+01	2.23E+01	1.03E+03			
Ni-59	5	5.64E+00	6.62E-01	3.38E-02	4.62E-01	1.56E+01	1.24E-01	1.38E+00	1.89E+02			
Ni-63	6	1.57E+02	1.32E+02	8.51E+00	7.41E+01	4.21E+02	1.33E+01	5.90E+01	5.28E+03			
Sr-90	8	5.09E+00	1.60E+01	1.36E+01	8.10E+00	2.34E+01	1.86E+01	1.78E+01	1.74E+02			
Zr-93	10	6.56E-06	1.09E-06	6.33E-04	7.76E-02	1.24E-02	1.24E-02	3.91E-02	1.42E-01			
Nb-94	11	9.02E-03	2.10E-02	1.05E-03	1.46E-02	9.17E-03	3.90E-03	4.94E-03	4.66E-01			
Tc-99	12	2.69E-02	1.37E-01	4.83E-03	2.56E-02	1.90E-02	8.85E-03	1.77E-02	1.23E+00			
I-129	13	7.07E-02	4.04E-01	1.04E-02	7.04E-02	3.19E-02	2.38E-02	4.93E-02	3.29E+00			
Cs-135	14	2.48E-02	6.15E+00	3.67E-03	2.50E-02	1.24E-02	8.84E-03	1.71E-02	7.17E+00			
Cs-137	15	3.32E+02	1.90E+03	6.29E+01	3.55E+02	1.78E+02	1.29E+02	2.58E+02	1.45E+04			
Pm-147	17	2.70E-04	7.86E-04	7.64E-01	2.00E-02	1.25E-01	3.87E-02	9.78E-02	1.05E+00			
Pb-210	20	8.10E-01	4.15E-01	4.49E-01	9.24E-01	1.52E+00	6.24E-01	2.13E+00	2.09E+01			
Po-210	28	8.01E-01	4.10E-01	4.43E-01	9.12E-01	1.50E+00	6.15E-01	2.10E+00	2.08E+01			
Ra-226	39	1.32E+00	7.02E-01	7.67E-01	1.60E+00	2.70E+00	1.13E+00	3.92E+00	2.73E+01			
Ra-228	40	3.29E+00	6.41E-02	5.18E-01	1.13E-01	1.41E-01	9.22E-02	8.80E-01	6.42E+00			
Ac-227	41	1.41E-04	3.57E-05	5.32E-05	3.79E-05	3.40E-05	3.45E-05	5.16E-05	5.54E-01			
Th-228	44	3.24E+00	6.31E-02	5.09E-01	1.11E-01	1.38E-01	9.01E-02	8.59E-01	6.32E+00			
Th-230	45	4.96E-03	1.28E-03	1.82E-03	1.36E-03	1.19E-03	1.34E-03	2.08E-03	1.19E+01			
Th-232	47	3.38E+00	6.62E-02	5.37E-01	1.77E-01	1.47E-01	9.67E-02	9.23E-01	6.62E+00			
Pa-231	49	3.94E-04	1.04E-04	1.48E-04	1.10E-04	1.03E-04	1.08E-04	1.64E-04	5.55E-01			
U-233	51	6.69E-05	2.46E+00	1.75E-03	7.15E-04	3.66E-04	9.41E-05	1.14E-04	2.46E+00			
U-234	52	1.84E+01	5.16E+00	7.75E+00	5.74E+00	5.01E+00	5.77E+00	9.12E+00	9.75E+01			
U-235	53	6.15E-01	1.71E-01	2.33E-01	1.82E-01	1.80E-01	1.97E-01	3.05E-01	3.53E+00			
U-238	54	4.04E+01	1.08E+01	1.40E+01	1.18E+01	1.14E+01	1.32E+01	2.10E+01	1.92E+02			
Pu-238	55	4.16E+03	4.34E+03	1.23E+04	5.49E+03	2.06E+01	4.20E+00	4.30E-01	2.65E+04			
Pu-239	56	2.07E+01	5.81E+01	2.84E+00	4.80E-01	2.71E+01	1.06E+01	3.49E-01	1.84E+02			
Pu-240	57	1.82E+01	5.48E+01	5.59E-02	5.42E-02	1.71E+01	3.39E+00	4.05E-03	1.09E+02			
Pu-241	58	5.84E+02	1.89E+03	3.32E+00	8.18E+00	6.45E+02	1.29E+02	4.92E+00	3.89E+03			
Am-241	59	6.29E+01	1.88E+02	1.12E+01	9.73E+00	5.43E+01	1.09E+01	7.87E-01	4.38E+02			
Cm-242	60	8.45E-06	1.41E-06	2.23E-04	9.13E-05	4.69E-05	1.21E-05	1.44E-05	4.10E-04			
TOTAL		1.24E+04	1.26E+04	1.96E+04	1.47E+04	3.89E+03	1.81E+03	1.23E+03	9.17E+04			



Figure 4-1. Aerial Photo of the SDA (1998)

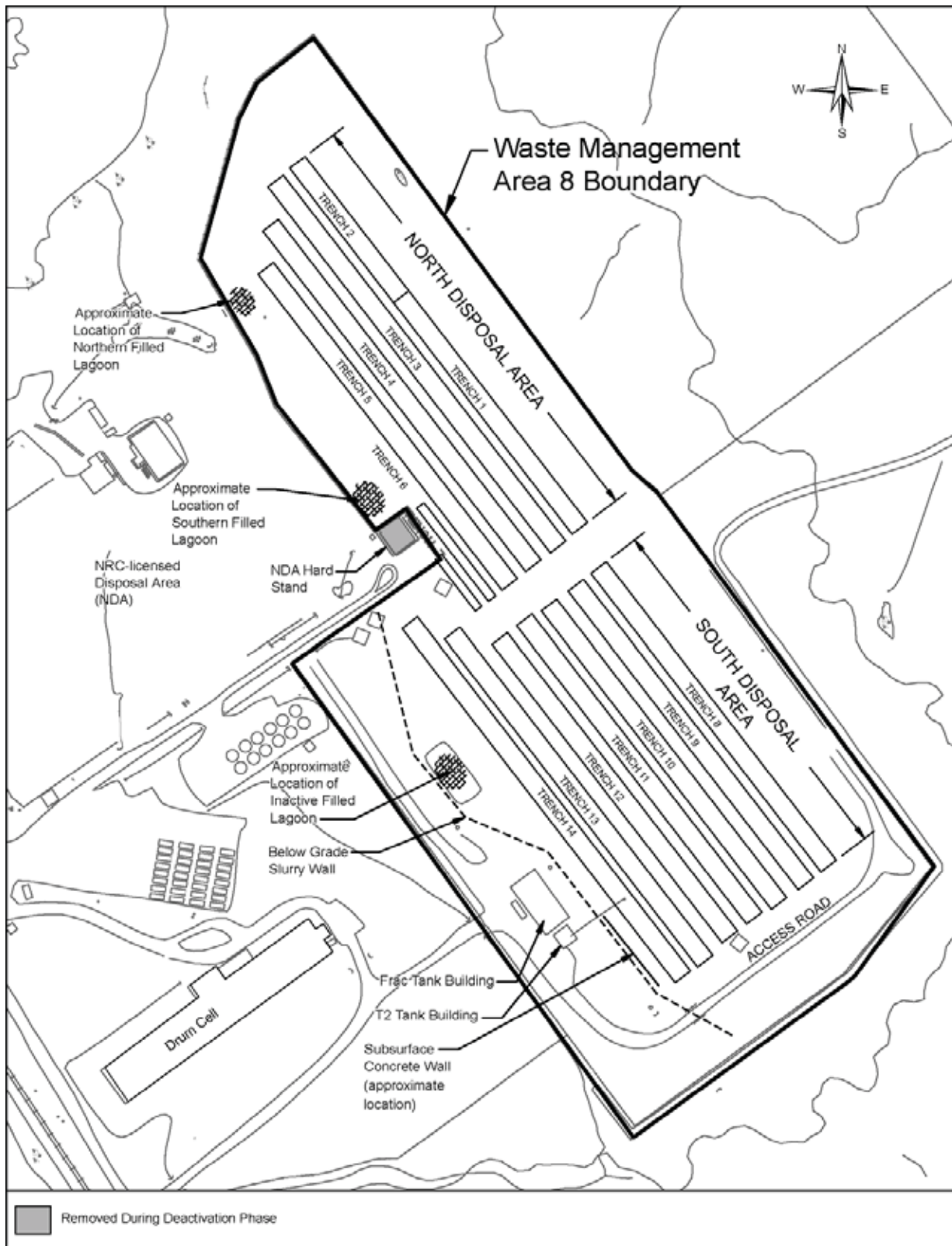

Figure 4-2. SDA Trenches (from Reference 4-1)

APPENDIX 4A

SDA TRENCH RADIONUCLIDE INVENTORIES

Tables 4A-1 through 4A-14 list the detailed radionuclide inventories at 50-foot intervals for each trench at the SDA. These tabulations are reproduced from the database that was used to derive the information in Reference 4A-1, Appendix C. The inventories are estimated according to the Variable Concentration Method, as described in that report. The authors of Reference 4A-1 supplied the QRA team with the current (July 2008) version of the database, which may contain minor differences from the data in the 2002 report. The data in Tables 4A-1 through 4A-14 formed the basis for all analyses in this risk assessment.

4A.1 REFERENCES

- 4A-1. "SDA Radiological Characterization Report", Wild, R. E., prepared for West Valley Nuclear Services Company, Inc., URS Corporation, 2002

Table 4A-1. SDA Trench 1 Radionuclide Inventory (Page 1 of 4)

Nuclide	Curies per Trench Interval (feet from North end)									
	0 - 49	50 - 99	100 - 149	150 - 199	200 - 249	250 - 299	300 - 349	350 - 399		
H-3	4.61E-02	4.01E-01	4.96E+00	1.69E+00	1.18E+00	0	1.26E-01	2.68E-01		
C-14	1.60E-02	1.25E-01	1.60E+00	5.15E-01	3.64E-01	0	3.82E-02	8.39E-02		
Fe-55	6.91E-05	3.09E-04	1.00E-02	1.74E-03	8.86E-04	0	9.72E-05	1.40E-03		
Co-60	1.22E-02	3.29E-01	1.63E+00	2.77E-01	1.46E-01	0	1.60E-02	2.04E-01		
Ni-59	8.49E-04	3.38E-03	9.89E-02	1.82E-02	9.59E-03	0	1.05E-03	1.34E-02		
Ni-63	2.02E-01	8.14E-01	9.13E+00	3.47E+00	2.31E+00	0	2.54E-01	7.02E-01		
Kr-85	0	0	5.04E-02	0	0	0	0	0		
Sr-90	9.09E-03	8.87E-02	9.98E-01	3.90E-01	2.65E-01	0	2.88E-02	6.73E-02		
Y-90	9.09E-03	8.87E-02	9.99E-01	3.90E-01	2.65E-01	0	2.88E-02	6.73E-02		
Zr-93	0	0	0	0	0	0	0	0		
Nb-94	2.68E-05	1.07E-04	3.13E-03	5.77E-04	3.04E-04	0	3.34E-05	4.23E-04		
Tc-99	7.34E-05	8.77E-04	1.17E-02	4.06E-03	2.63E-03	0	2.89E-04	1.07E-03		
I-129	2.15E-04	2.59E-03	3.36E-02	1.19E-02	7.78E-03	0	8.55E-04	3.01E-03		
Cs-135	7.26E-05	8.77E-04	1.17E-02	4.06E-03	2.63E-03	0	2.89E-04	1.08E-03		
Cs-137	8.50E-01	1.03E+01	1.37E+02	4.77E+01	3.09E+01	0	3.40E+00	1.25E+01		
Ba-137m	8.04E-01	9.76E+00	1.30E+02	4.51E+01	2.93E+01	0	3.22E+00	1.19E+01		
Pm-147	0	0	0	0	0	0	0	0		
Ti-207	2.27E-07	1.97E-08	1.76E-07	1.79E-06	3.57E-07	0	4.96E-09	5.73E-07		
Ti-208	0	2.42E-05	5.85E-03	2.07E-01	6.91E-03	0	0	0		
Pb-210	7.88E-09	4.58E-11	1.01E-01	6.68E-08	1.39E-02	0	1.62E-13	2.44E-08		
Pb-211	2.28E-07	1.97E-08	1.77E-07	1.79E-06	3.58E-07	0	4.97E-09	5.74E-07		
Pb-212	0	6.74E-05	1.63E-02	5.77E-01	1.92E-02	0	0	0		
Pb-214	2.76E-08	1.59E-10	1.50E-01	2.34E-07	2.07E-02	0	0	0		
Pb-214	2.76E-08	1.59E-10	1.50E-01	2.34E-07	2.07E-02	0	0	0		
Bi-210	7.87E-09	4.57E-11	1.01E-01	6.67E-08	1.39E-02	0	1.61E-13	2.44E-08		
Bi-211	2.28E-07	1.97E-08	1.77E-07	1.79E-06	3.58E-07	0	4.97E-09	5.74E-07		
Bi-212	0	6.74E-05	1.63E-02	5.77E-01	1.92E-02	0	0	0		
Bi-214	2.76E-08	1.59E-10	1.50E-01	2.34E-07	2.07E-02	0	0	0		
Po-210	7.55E-09	4.39E-11	1.00E-01	6.40E-08	1.38E-02	0	1.53E-13	2.33E-08		
Po-212	0	0	1.04E-02	3.70E-01	1.23E-02	0	0	0		
Po-214	0	0	1.50E-01	0	2.07E-02	0	0	0		
Po-215	0	0	0	1.79E-06	0	0	0	0		
Po-216	0	6.74E-05	1.63E-02	5.77E-01	1.92E-02	0	0	0		
Po-218	2.76E-08	1.59E-10	1.50E-01	2.34E-07	2.07E-02	0	0	0		
Rn-219	2.28E-07	1.97E-08	1.77E-07	1.79E-06	3.58E-07	0	4.97E-09	5.74E-07		
Rn-220	0	6.74E-05	1.63E-02	5.77E-01	1.92E-02	0	0	0		

Table 4A-1. SDA Trench 1 Radionuclide Inventory (Page 2 of 4)

Nuclide	Curies per Trench Interval (feet from North end)									
	0 - 49	50 - 99	100 - 149	150 - 199	200 - 249	250 - 299	300 - 349	350 - 399		
Rn-222	2.76E-08	1.59E-10	1.50E-01	2.34E-07	2.07E-02	0	7.11E-13	8.54E-08		
Ra-223										
Ra-224										
Ra-226										
Ra-228										
Ac-227	2.29E-07	1.98E-08	1.78E-07	1.80E-06	3.60E-07	0	5.00E-09	5.77E-07		
Ac-228	0	6.78E-05	1.64E-02	5.81E-01	1.94E-02	0	0	0		
Th-227	2.25E-07	1.95E-08	1.75E-07	1.77E-06	3.54E-07	0	4.92E-09	5.67E-07		
Th-228	0	6.74E-05	1.63E-02	5.77E-01	1.92E-02	0	0	0		
Th-230	3.61E-06	2.06E-08	4.71E-09	3.06E-05	6.19E-06	0	1.36E-10	1.12E-05		
Th-231										
Th-232										
Th-234										
Pa-231										
Pa-234m										
U-233	2.69E-12	2.85E-11	3.13E-10	1.27E-10	8.52E-11	0	9.36E-12	2.31E-11		
U-234	1.13E-02	6.47E-05	2.81E-05	9.58E-02	1.94E-02	0	8.16E-07	3.49E-02		
U-235	7.62E-04	6.58E-05	5.88E-04	6.00E-03	1.20E-03	0	1.66E-05	1.92E-03		
U-238	9.32E-04	3.99E-04	4.08E-03	9.37E-03	2.73E-03	0	1.30E-04	3.06E-03		
Pu-238	1.94E-03	2.10E-02	2.38E-01	9.44E-02	6.29E-02	0	6.91E-03	1.84E-02		
Pu-239	1.61E-03	1.95E-02	2.13E-01	8.73E-02	5.84E-02	0	6.42E-03	1.58E-02		
Pu-240										
Pu-241										
Am-241										
Cm-242										
Total	1.99	22.16	290.13	106.57	65.85	0	7.19	26.04		

Table 4A-1. SDA Trench 1 Radionuclide Inventory (Page 3 of 4)

Nuclide	Curies per Trench Interval (feet from North end)							Total
	400 - 449	450 - 499	500 - 549	550 - 599	600 - 649	650 - 699	700 - 750	
H-3	0	0	0	0	0	0	0	8.68E+00
C-14	0	0	0	0	0	0	0	2.74E+00
Fe-55	0	0	0	0	0	0	0	1.45E-02
Co-60	0	0	0	0	0	0	0	2.62E+00
Ni-59	0	0	0	0	0	0	0	1.45E-01
Ni-63								
Kr-85								
Sr-90								
Y-90								
Zr-93								
Nb-94	0	0	0	0	0	0	0	4.60E-03
Tc-99	0	0	0	0	0	0	0	2.06E-02
I-129	0	0	0	0	0	0	0	6.00E-02
Cs-135	0	0	0	0	0	0	0	2.07E-02
Cs-137	0	0	0	0	0	0	0	2.43E+02
Ba-137m								
Pm-147								
Tl-207								
Tl-208								
Pb-210								
Pb-211	0	0	0	0	0	0	0	3.16E-06
Pb-212	0	0	0	0	0	0	0	6.13E-01
Pb-214	0	0	0	0	0	0	0	1.71E-01
Bi-210	0	0	0	0	0	0	0	1.15E-01
Bi-211	0	0	0	0	0	0	0	3.16E-06
Bi-212								
Bi-214								
Po-210								
Po-212								
Po-214								
Po-215	0	0	0	0	0	0	0	1.79E-06
Po-216	0	0	0	0	0	0	0	6.13E-01
Po-218	0	0	0	0	0	0	0	1.71E-01
Rn-219	0	0	0	0	0	0	0	3.16E-06
Rn-220	0	0	0	0	0	0	0	6.13E-01

Table 4A-1. SDA Trench 1 Radionuclide Inventory (Page 4 of 4)

Nuclide	Curies per Trench Interval (feet from North end)										Total
	400 - 449	450 - 499	500 - 549	550 - 599	600 - 649	650 - 699	700 - 750				
Rn-222	0	0	0	0	0	0	0	0	0	0	1.71E-01
Ra-223	0	0	0	0	0	0	0	0	0	0	3.16E-06
Ra-224	0	0	0	0	0	0	0	0	0	0	6.13E-01
Ra-226	0	0	0	0	0	0	0	0	0	0	1.71E-01
Ra-228	0	0	0	0	0	0	0	0	0	0	6.17E-01
Ac-227	0	0	0	0	0	0	0	0	0	0	3.17E-06
Ac-228	0	0	0	0	0	0	0	0	0	0	6.17E-01
Th-227	0	0	0	0	0	0	0	0	0	0	3.12E-06
Th-228	0	0	0	0	0	0	0	0	0	0	6.13E-01
Th-230	0	0	0	0	0	0	0	0	0	0	5.16E-05
Th-231	0	0	0	0	0	0	0	0	0	0	1.05E-02
Th-232	0	0	0	0	0	0	0	0	0	0	6.26E-01
Th-234	0	0	0	0	0	0	0	0	0	0	2.07E-02
Pa-231	0	0	0	0	0	0	0	0	0	0	7.91E-06
Pa-234m	0	0	0	0	0	0	0	0	0	0	2.07E-02
U-233	0	0	0	0	0	0	0	0	0	0	5.89E-10
U-234	0	0	0	0	0	0	0	0	0	0	1.62E-01
U-235	0	0	0	0	0	0	0	0	0	0	1.05E-02
U-238	0	0	0	0	0	0	0	0	0	0	2.07E-02
Pu-238	0	0	0	0	0	0	0	0	0	0	4.43E-01
Pu-239	0	0	0	0	0	0	0	0	0	0	4.02E-01
Pu-240	0	0	0	0	0	0	0	0	0	0	6.60E-04
Pu-241	0	0	0	0	0	0	0	0	0	0	3.20E+00
Am-241	0	0	0	0	0	0	0	0	0	0	8.56E-01
Cm-242	0	0	0	0	0	0	0	0	0	0	0
Total	0	0	0	0	0	0	0	0	0	0	519.92

Table 4A-2. SDA Trench 2 Radionuclide Inventory (Page 1 of 4)

Nuclide	Curies per Trench Interval (feet from North end)									
	0 - 49	50 - 99	100 - 149	150 - 199	200 - 249	250 - 299	300 - 349	350 - 399		
H-3	3.94E+00	6.40E-01	2.74E-01	3.24E-01	2.58E-01	7.69E-01	7.29E+01	2.57E-01		
C-14	1.43E+00	1.99E-01	9.01E-02	1.01E-01	8.10E-02	2.61E-01	1.56E+00	7.80E-02		
Fe-55	1.11E-01	2.76E-03	3.09E-03	1.50E-03	1.45E-03	3.98E-03	3.67E-03	1.99E-04		
Co-60	1.58E+01	6.69E-01	4.44E-01	2.19E-01	2.10E-01	5.79E-01	9.82E-01	3.27E-02		
Ni-59	1.04E+00	2.65E-02	2.92E-02	1.44E-02	1.38E-02	3.79E-02	3.87E-02	2.15E-03		
Ni-63	2.24E+01	1.60E+00	9.28E-01	8.21E-01	6.88E-01	1.69E+00	7.76E+00	5.18E-01		
Kr-85	0	0	0	0	0	0	0	0		
Sr-90										
Y-90										
Zr-93										
Nb-94	3.28E-02	8.37E-04	9.21E-04	4.54E-04	4.36E-04	1.20E-03	1.23E-03	6.82E-05		
Tc-99	4.96E-02	2.32E-03	1.70E-03	1.22E-03	1.06E-03	2.72E-03	8.67E-03	5.91E-04		
I-129	1.34E-01	6.59E-03	4.69E-03	3.45E-03	2.99E-03	7.61E-03	2.56E-02	1.75E-03		
Cs-135	5.07E-02	2.34E-03	1.73E-03	1.23E-03	1.08E-03	2.75E-03	8.68E-03	5.91E-04		
Cs-137	5.85E+02	2.73E+01	2.01E+01	1.43E+01	1.25E+01	3.20E+01	1.02E+02	6.95E+00		
Ba-137m										
Pm-147										
Tl-207										
Tl-208										
Pb-210										
Pb-211	7.09E-07	2.54E-08	5.93E-08	6.14E-08	5.88E-08	8.11E-08	9.39E-07	1.02E-08		
Pb-212	0	0	0	0	0	4.81E-03	3.89E-04	0		
Pb-214	1.51E-02	1.78E-01	2.43E-12	2.23E-12	1.85E-12	1.21E-02	1.12E-03	1.45E-12		
Bi-210	1.02E-02	1.20E-01	5.52E-13	5.06E-13	4.21E-13	8.12E-03	7.55E-04	3.30E-13		
Bi-211	7.09E-07	2.54E-08	5.93E-08	6.14E-08	5.88E-08	8.11E-08	9.39E-07	1.02E-08		
Bi-212										
Bi-214										
Po-210										
Po-212										
Po-214										
Po-215	0	0	0	0	0	0	0	0		
Po-216	0	0	0	0	0	4.81E-03	3.89E-04	0		
Po-218	1.51E-02	1.78E-01	0	0	0	1.21E-02	1.12E-03	0		
Rn-219	7.09E-07	2.54E-08	5.93E-08	6.14E-08	5.88E-08	8.11E-08	9.39E-07	1.02E-08		
Rn-220	0	0	0	0	0	4.81E-03	3.89E-04	0		

Table 4A-2. SDA Trench 2 Radionuclide Inventory (Page 2 of 4)

Nuclide	Curies per Trench Interval (feet from North end)										
	0 - 49	50 - 99	100 - 149	150 - 199	200 - 249	250 - 299	300 - 349	350 - 399			
Rn-222	1.51E-02	1.78E-01	2.43E-12	2.23E-12	1.85E-12	1.21E-02	1.12E-03	1.45E-12			
Ra-223	7.09E-07	2.54E-08	5.93E-08	6.14E-08	5.88E-08	8.11E-08	9.39E-07	1.02E-08			
Ra-224	0	0	0	0	0	4.81E-03	3.89E-04	0			
Ra-226	1.51E-02	1.78E-01	2.43E-12	2.23E-12	1.85E-12	1.21E-02	1.12E-03	1.46E-12			
Ra-228	0	0	0	0	0	4.84E-03	3.92E-04	0			
Ac-227	7.13E-07	2.55E-08	5.96E-08	6.17E-08	5.91E-08	8.15E-08	9.44E-07	1.02E-08			
Ac-228	0	0	0	0	0	4.84E-03	3.92E-04	0			
Th-227	7.01E-07	2.51E-08	5.86E-08	6.07E-08	5.81E-08	8.01E-08	9.28E-07	1.00E-08			
Th-228	0	0	0	0	0	4.81E-03	3.89E-04	0			
Th-230	7.15E-06	8.95E-10	4.66E-10	4.27E-10	3.55E-10	1.24E-07	1.66E-05	2.79E-10			
Th-231	2.37E-03	8.48E-05	1.98E-04	2.05E-04	1.96E-04	2.71E-04	3.14E-03	3.40E-05			
Th-232	4.49E-19	2.75E-20	1.73E-20	1.43E-20	1.21E-20	4.91E-03	3.98E-04	8.37E-21			
Th-234	1.61E-02	6.66E-04	2.83E-04	3.38E-04	2.69E-04	1.03E-03	5.66E-02	2.66E-04			
Pa-231	1.78E-06	6.37E-08	1.49E-07	1.54E-07	1.47E-07	2.03E-07	2.35E-06	2.55E-08			
Pa-234m	1.61E-02	6.66E-04	2.83E-04	3.38E-04	2.69E-04	1.03E-03	5.66E-02	2.66E-04			
U-233	5.75E-10	5.35E-11	2.76E-11	2.74E-11	2.25E-11	5.44E-11	2.74E-10	1.91E-11			
U-234	2.24E-02	5.17E-06	2.79E-06	2.56E-06	2.12E-06	3.90E-04	5.19E-02	1.67E-06			
U-235	2.37E-03	8.48E-05	1.98E-04	2.05E-04	1.96E-04	2.71E-04	3.14E-03	3.40E-05			
U-238	1.61E-02	6.66E-04	2.83E-04	3.38E-04	2.69E-04	1.03E-03	5.66E-02	2.66E-04			
Pu-238	5.51E-01	4.21E-02	2.37E-02	2.17E-02	1.81E-02	4.42E-02	2.03E-01	1.41E-02			
Pu-239	3.96E-01	3.67E-02	2.99E-01	2.98E-01	2.95E-01	3.17E-01	1.88E-01	1.31E-02			
Pu-240	1.09E-03	6.67E-05	4.20E-05	3.46E-05	2.93E-05	7.31E-05	2.93E-04	2.03E-05			
Pu-241	3.38E+00	2.96E-01	1.57E-01	1.52E-01	1.25E-01	3.03E-01	1.49E+00	1.04E-01			
Am-241	8.71E-01	7.84E-02	4.10E-02	4.02E-02	3.31E-02	8.01E-02	3.98E-01	2.78E-02			
Cm-242	0	0	0	0	0	0	0	0			
Total	1,190.81	58.48	41.50	30.00	26.21	66.87	288.18	14.69			

Table 4A-2. SDA Trench 2 Radionuclide Inventory (Page 3 of 4)

Nuclide	Curies per Trench Interval (feet from North end)										Total
	400 - 449	450 - 499	500 - 549	550 - 599	600 - 649	650 - 699	700 - 750				
H-3	0	0	0	0	0	0	0	0	0	0	7.93E+01
C-14	0	0	0	0	0	0	0	0	0	0	3.80E+00
Fe-55	0	0	0	0	0	0	0	0	0	0	1.27E-01
Co-60	0	0	0	0	0	0	0	0	0	0	1.90E+01
Ni-59	0	0	0	0	0	0	0	0	0	0	1.20E+00
Ni-63	0	0	0	0	0	0	0	0	0	0	3.64E+01
Kr-85	0	0	0	0	0	0	0	0	0	0	0
Sr-90	0	0	0	0	0	0	0	0	0	0	4.08E+00
Y-90	0	0	0	0	0	0	0	0	0	0	4.08E+00
Zr-93	0	0	0	0	0	0	0	0	0	0	0
Nb-94	0	0	0	0	0	0	0	0	0	0	3.80E-02
Tc-99	0	0	0	0	0	0	0	0	0	0	6.79E-02
I-129	0	0	0	0	0	0	0	0	0	0	1.86E-01
Cs-135	0	0	0	0	0	0	0	0	0	0	6.91E-02
Cs-137	0	0	0	0	0	0	0	0	0	0	8.00E+02
Ba-137m	0	0	0	0	0	0	0	0	0	0	7.56E+02
Pm-147	0	0	0	0	0	0	0	0	0	0	0
Tl-207	0	0	0	0	0	0	0	0	0	0	1.94E-06
Tl-208	0	0	0	0	0	0	0	0	0	0	1.87E-03
Pb-210	0	0	0	0	0	0	0	0	0	0	1.39E-01
Pb-211	0	0	0	0	0	0	0	0	0	0	1.94E-06
Pb-212	0	0	0	0	0	0	0	0	0	0	5.20E-03
Pb-214	0	0	0	0	0	0	0	0	0	0	2.06E-01
Bi-210	0	0	0	0	0	0	0	0	0	0	1.39E-01
Bi-211	0	0	0	0	0	0	0	0	0	0	1.94E-06
Bi-212	0	0	0	0	0	0	0	0	0	0	5.20E-03
Bi-214	0	0	0	0	0	0	0	0	0	0	2.06E-01
Po-210	0	0	0	0	0	0	0	0	0	0	1.37E-01
Po-212	0	0	0	0	0	0	0	0	0	0	0
Po-214	0	0	0	0	0	0	0	0	0	0	2.06E-01
Po-215	0	0	0	0	0	0	0	0	0	0	0
Po-216	0	0	0	0	0	0	0	0	0	0	5.20E-03
Po-218	0	0	0	0	0	0	0	0	0	0	2.06E-01
Rn-219	0	0	0	0	0	0	0	0	0	0	1.94E-06
Rn-220	0	0	0	0	0	0	0	0	0	0	5.20E-03

Table 4A-2. SDA Trench 2 Radionuclide Inventory (Page 4 of 4)

Nuclide	Curies per Trench Interval (feet from North end)										Total		
	400 - 449	450 - 499	500 - 549	550 - 599	600 - 649	650 - 699	700 - 750						
Rn-222	0	0	0	0	0	0	0	0	0	0	0	2.06E-01	
Ra-223	0	0	0	0	0	0	0	0	0	0	0	1.94E-06	
Ra-224	0	0	0	0	0	0	0	0	0	0	0	5.20E-03	
Ra-226	0	0	0	0	0	0	0	0	0	0	0	2.06E-01	
Ra-228	0	0	0	0	0	0	0	0	0	0	0	5.23E-03	
Ac-227	0	0	0	0	0	0	0	0	0	0	0	1.95E-06	
Ac-228	0	0	0	0	0	0	0	0	0	0	0	5.23E-03	
Th-227	0	0	0	0	0	0	0	0	0	0	0	1.92E-06	
Th-228	0	0	0	0	0	0	0	0	0	0	0	5.20E-03	
Th-230	0	0	0	0	0	0	0	0	0	0	0	2.39E-05	
Th-231	0	0	0	0	0	0	0	0	0	0	0	6.49E-03	
Th-232	0	0	0	0	0	0	0	0	0	0	0	5.31E-03	
Th-234	0	0	0	0	0	0	0	0	0	0	0	7.56E-02	
Pa-231	0	0	0	0	0	0	0	0	0	0	0	4.88E-06	
Pa-234m	0	0	0	0	0	0	0	0	0	0	0	7.56E-02	
U-233	0	0	0	0	0	0	0	0	0	0	0	1.05E-09	
U-234	0	0	0	0	0	0	0	0	0	0	0	7.47E-02	
U-235	0	0	0	0	0	0	0	0	0	0	0	6.49E-03	
U-238	0	0	0	0	0	0	0	0	0	0	0	7.56E-02	
Pu-238	0	0	0	0	0	0	0	0	0	0	0	9.18E-01	
Pu-239	0	0	0	0	0	0	0	0	0	0	0	1.84E+00	
Pu-240	0	0	0	0	0	0	0	0	0	0	0	1.65E-03	
Pu-241	0	0	0	0	0	0	0	0	0	0	0	6.01E+00	
Am-241	0	0	0	0	0	0	0	0	0	0	0	1.57E+00	
Cm-242	0	0	0	0	0	0	0	0	0	0	0	0	
Total	0	0	0	0	0	0	0	0	0	0	0	0	1,716.75

Table 4A-3. SDA Trench 3 Radionuclide Inventory (Page 1 of 4)

Nuclide	Curies per Trench Interval (feet from North end)									
	0 - 49	50 - 99	100 - 149	150 - 199	200 - 249	250 - 299	300 - 349	350 - 399		
H-3	5.95E+01	4.32E+00	8.42E+01	9.66E+01	1.29E+02	1.34E+02	1.29E+02	1.29E+02	2.55E-02	
C-14	8.40E-01	1.36E+00	6.49E-01	1.28E+00	1.08E+00	1.08E+00	8.69E-01	8.69E-01	1.10E-02	
Fe-55	2.68E-02	1.29E-02	3.98E-03	4.63E-03	1.22E-02	1.61E-02	1.44E-02	1.44E-02	2.27E-03	
Co-60	3.83E+00	2.18E+00	5.52E-01	6.69E-01	1.73E+00	2.04E+00	1.86E+00	1.86E+00	2.86E-01	
Ni-59	2.50E-01	1.40E-01	3.44E-02	4.10E-02	1.05E-01	1.17E-01	1.05E-01	1.05E-01	1.65E-02	
Ni-63	6.38E+00	3.38E+01	1.92E+00	6.07E+00	3.61E+00	3.19E+00	2.07E+00	2.07E+00	2.84E-01	
Kr-85	0	0	0	0	0	0	0	0	0	
Sr-90	4.56E-01	8.78E-01	7.92E-02	4.52E-01	2.62E-01	2.48E-01	1.21E-01	1.21E-01	1.46E-02	
Y-90	4.56E-01	8.78E-01	7.92E-02	4.52E-01	2.62E-01	2.48E-01	1.21E-01	1.21E-01	1.46E-02	
Zr-93	0	0	0	0	0	0	0	0	0	
Nb-94	7.90E-03	4.43E-03	1.09E-03	1.29E-03	3.33E-03	3.69E-03	3.30E-03	3.30E-03	5.20E-04	
Tc-99	1.29E-02	8.52E-03	1.75E-03	4.19E-03	5.94E-03	6.13E-03	4.59E-03	4.59E-03	7.11E-04	
I-129	3.49E-02	2.47E-02	4.79E-03	1.21E-02	1.63E-02	1.67E-02	1.22E-02	1.22E-02	1.89E-03	
Cs-135	1.31E-02	8.37E-03	1.77E-03	4.19E-03	6.04E-03	6.24E-03	4.69E-03	4.69E-03	7.29E-04	
Cs-137	1.52E+02	9.86E+01	2.07E+01	4.95E+01	7.07E+01	7.38E+01	5.53E+01	5.53E+01	8.57E+00	
Ba-137m	1.44E+02	9.32E+01	1.96E+01	4.69E+01	6.69E+01	6.98E+01	5.23E+01	5.23E+01	8.11E+00	
Pm-147	0	0	0	0	0	0	0	0	0	
Ti-207	3.38E-06	1.52E-07	1.31E-06	6.05E-08	1.17E-06	3.40E-08	1.90E-07	1.90E-07	1.00E-09	
Ti-208	1.74E-05	2.25E-05	1.73E-03	6.89E-03	1.38E-02	0	0	0	0	
Pb-210	2.45E-03	6.36E-02	7.20E-03	2.13E-12	3.19E-04	8.49E-04	9.42E-03	9.42E-03	1.40E-13	
Pb-211	3.39E-06	1.53E-07	1.31E-06	6.06E-08	1.17E-06	3.41E-08	1.90E-07	1.90E-07	1.00E-09	
Pb-212	4.85E-05	6.25E-05	4.81E-03	1.92E-02	3.84E-02	0	0	0	0	
Pb-214	3.69E-03	9.45E-02	1.07E-02	9.43E-12	4.82E-04	1.28E-03	1.42E-02	1.42E-02	0	
Bi-210	2.45E-03	6.36E-02	7.20E-03	2.13E-12	3.19E-04	8.49E-04	9.42E-03	9.42E-03	1.40E-13	
Bi-211	3.39E-06	1.53E-07	1.31E-06	6.06E-08	1.17E-06	3.41E-08	1.90E-07	1.90E-07	1.00E-09	
Bi-212	4.85E-05	6.25E-05	4.81E-03	1.92E-02	3.84E-02	0	0	0	0	
Bi-214	3.69E-03	9.45E-02	1.07E-02	9.43E-12	4.82E-04	1.28E-03	1.42E-02	1.42E-02	0	
Po-210	2.42E-03	6.30E-02	7.14E-03	2.01E-12	3.16E-04	8.41E-04	9.33E-03	9.33E-03	1.32E-13	
Po-212	0	0	0	1.23E-02	2.46E-02	0	0	0	0	
Po-214	3.69E-03	9.45E-02	1.07E-02	0	4.81E-04	1.28E-03	1.42E-02	1.42E-02	0	
Po-215	3.39E-06	0	1.31E-06	0	1.17E-06	0	0	0	0	
Po-216	4.85E-05	6.25E-05	4.81E-03	1.92E-02	3.84E-02	0	0	0	0	
Po-218	3.69E-03	9.45E-02	1.07E-02	0	4.82E-04	1.28E-03	1.42E-02	1.42E-02	0	
Rn-219	3.39E-06	1.53E-07	1.31E-06	6.06E-08	1.17E-06	3.41E-08	1.90E-07	1.90E-07	1.00E-09	
Rn-220	4.85E-05	6.25E-05	4.81E-03	1.92E-02	3.84E-02	0	0	0	0	

Table 4A-3. SDA Trench 3 Radionuclide Inventory (Page 2 of 4)

Nuclide	Curies per Trench Interval (feet from North end)										
	0 - 49	50 - 99	100 - 149	150 - 199	200 - 249	250 - 299	300 - 349	350 - 399			
Rn-222	3.69E-03	9.45E-02	1.07E-02	9.43E-12	4.82E-04	1.28E-03	1.42E-02	6.30E-13			
Ra-223	3.39E-06	1.53E-07	1.31E-06	6.06E-08	1.17E-06	3.41E-08	1.90E-07	1.00E-09			
Ra-224	4.85E-05	6.25E-05	4.81E-03	1.92E-02	3.84E-02	0	0	0			
Ra-226	3.69E-03	9.45E-02	1.07E-02	9.44E-12	4.82E-04	1.28E-03	1.42E-02	6.31E-13			
Ra-228	4.89E-05	6.29E-05	4.84E-03	1.93E-02	3.87E-02	0	1.46E-16	0			
Ac-227	3.41E-06	1.54E-07	1.32E-06	6.10E-08	1.18E-06	3.43E-08	1.91E-07	1.01E-09			
Ac-228	4.89E-05	6.29E-05	4.84E-03	1.93E-02	3.87E-02	0	0	0			
Th-227	3.35E-06	1.51E-07	1.30E-06	5.99E-08	1.16E-06	3.37E-08	1.88E-07	9.91E-10			
Th-228	4.85E-05	6.25E-05	4.81E-03	1.92E-02	3.84E-02	0	1.21E-16	0			
Th-230	8.60E-05	4.74E-09	2.55E-05	1.82E-09	2.14E-05	1.43E-09	3.06E-08	1.24E-10			
Th-231	1.14E-02	5.10E-04	4.41E-03	2.04E-04	4.11E-03	1.20E-04	6.67E-04	3.52E-06			
Th-232	4.97E-05	6.38E-05	4.91E-03	1.96E-02	3.93E-02	5.46E-20	2.31E-16	5.53E-21			
Th-234	1.18E-01	4.01E-03	8.15E-02	1.60E-03	7.11E-02	7.73E-04	3.08E-04	2.76E-05			
Pa-231	8.53E-06	3.83E-07	3.30E-06	1.53E-07	3.00E-06	8.73E-08	4.86E-07	2.56E-09			
Pa-234m	1.18E-01	4.01E-03	8.15E-02	1.60E-03	7.11E-02	7.73E-04	3.08E-04	2.76E-05			
U-233	1.70E-10	3.25E-10	9.15E-10	1.22E-10	9.07E-11	8.03E-11	4.14E-10	5.98E-12			
U-234	2.70E-01	2.84E-05	7.98E-02	1.10E-05	6.90E-02	8.79E-06	1.17E-04	7.66E-07			
U-235	1.14E-02	5.10E-04	4.41E-03	2.04E-04	4.11E-03	1.20E-04	6.67E-04	3.52E-06			
U-238	1.18E-01	4.01E-03	8.15E-02	1.60E-03	7.11E-02	7.73E-04	3.08E-04	2.76E-05			
Pu-238	1.57E-01	2.41E-01	7.28E-01	9.36E-02	8.22E-02	7.75E-02	3.41E-01	6.79E-03			
Pu-239	1.18E+00	1.86E-01	6.15E-01	8.10E-02	6.44E-02	5.86E-02	2.81E-01	4.38E-03			
Pu-240	2.95E-04	3.20E-04	6.30E-01	1.36E-04	1.44E-04	1.41E-04	2.65E-01	1.43E-05			
Pu-241	1.01E+00	1.88E+00	1.62E+01	6.93E-01	5.56E-01	5.17E-01	7.04E+00	4.07E-02			
Am-241	2.59E-01	4.82E-01	2.25E+00	1.81E-01	1.40E-01	1.27E-01	9.94E-01	9.78E-03			
Cm-242	0	0	0	0	0	0	0	0			
Total	370.38	238.97	148.63	203.27	275.44	285.07	250.46	17.40			

Table 4A-3. SDA Trench 3 Radionuclide Inventory (Page 3 of 4)

Nuclide	Curies per Trench Interval (feet from North end)										Total
	400 - 449	450 - 499	500 - 549	550 - 599	600 - 649	650 - 699	700 - 750				
H-3	2.60E-02	2.54E-02	1.08E+02	3.13E+01	4.18E+00	1.28E+02	0	0	0	0	9.07E+02
C-14	1.11E-02	1.09E-02	9.61E-01	1.01E+00	1.35E+00	1.55E+00	0	0	0	0	1.21E+01
Fe-55	2.27E-03	2.26E-03	8.27E-03	3.33E-02	2.74E-02	9.01E-03	0	0	0	0	1.76E-01
Co-60	2.86E-01	2.84E-01	1.06E+00	4.24E+00	3.54E+00	1.19E+00	0	0	0	0	2.38E+01
Ni-59	1.65E-02	1.63E-02	6.10E-02	2.44E-01	2.02E-01	6.52E-02	0	0	0	0	1.41E+00
Ni-63	2.85E-01	2.82E-01	2.97E+00	8.93E+00	8.73E+00	1.24E+00	0	0	0	0	7.98E+01
Kr-85	0	0	0	0	0	0	0	0	0	0	0
Sr-90	1.47E-02	1.45E-02	1.59E-01	6.97E-01	9.84E-01	3.70E-01	0	0	0	0	4.75E+00
Y-90	1.47E-02	1.45E-02	1.59E-01	6.97E-01	9.85E-01	3.70E-01	0	0	0	0	4.75E+00
Zr-93	0	0	7.16E-09	6.47E-08	2.88E-08	5.08E-08	0	0	0	0	1.51E-07
Nb-94	5.20E-04	5.16E-04	1.93E-03	7.71E-03	6.37E-03	2.06E-03	0	0	0	0	4.47E-02
Tc-99	7.12E-04	7.06E-04	2.94E-03	1.44E-02	1.40E-02	2.86E-03	0	0	0	0	8.03E-02
I-129	1.90E-03	1.88E-03	8.01E-03	3.97E-02	3.91E-02	7.61E-03	0	0	0	0	2.22E-01
Cs-135	7.29E-04	7.23E-04	2.99E-03	1.46E-02	1.42E-02	2.92E-03	0	0	0	0	8.13E-02
Cs-137	8.58E+00	8.51E+00	3.54E+01	1.73E+02	1.69E+02	3.47E+01	0	0	0	0	9.58E+02
Ba-137m	8.12E+00	8.05E+00	3.35E+01	1.64E+02	1.60E+02	3.28E+01	0	0	0	0	9.06E+02
Pm-147	0	0	6.13E-08	5.54E-07	2.47E-07	4.35E-07	0	0	0	0	1.30E-06
Ti-207	2.01E-07	9.92E-10	1.40E-06	9.39E-08	6.07E-07	1.06E-06	0	0	0	0	9.66E-06
Ti-208	0	0	1.20E-08	1.08E-07	4.82E-08	3.14E-03	0	0	0	0	2.56E-02
Pb-210	1.41E-13	1.39E-13	3.04E-03	7.83E-03	2.32E-08	1.92E-01	0	0	0	0	2.87E-01
Pb-211	2.01E-07	9.95E-10	1.40E-06	9.42E-08	6.09E-07	1.06E-06	0	0	0	0	9.69E-06
Pb-212	0	0	3.34E-08	3.02E-07	1.34E-07	8.74E-03	0	0	0	0	7.12E-02
Pb-214	0	0	4.60E-03	1.18E-02	8.30E-08	2.90E-01	0	0	0	0	4.31E-01
Bi-210	1.40E-13	1.39E-13	3.04E-03	7.82E-03	2.32E-08	1.92E-01	0	0	0	0	2.87E-01
Bi-211	2.01E-07	9.95E-10	1.40E-06	9.42E-08	6.09E-07	1.06E-06	0	0	0	0	9.69E-06
Bi-212	0	0	3.34E-08	3.02E-07	1.34E-07	8.74E-03	0	0	0	0	7.12E-02
Bi-214	0	0	4.60E-03	1.18E-02	8.30E-08	2.90E-01	0	0	0	0	4.31E-01
Po-210	1.32E-13	1.31E-13	3.02E-03	7.75E-03	2.22E-08	1.90E-01	0	0	0	0	2.84E-01
Po-212	0	0	0	0	0	0	0	0	0	0	3.69E-02
Po-214	0	0	4.60E-03	1.18E-02	0	2.90E-01	0	0	0	0	4.31E-01
Po-215	0	0	1.40E-06	0	0	1.06E-06	0	0	0	0	8.34E-06
Po-216	0	0	3.34E-08	3.02E-07	1.34E-07	8.74E-03	0	0	0	0	7.12E-02
Po-218	0	0	4.60E-03	1.18E-02	8.30E-08	2.90E-01	0	0	0	0	4.31E-01
Rn-219	2.01E-07	9.95E-10	1.40E-06	9.42E-08	6.09E-07	1.06E-06	0	0	0	0	9.69E-06
Rn-220	0	0	3.34E-08	3.02E-07	1.34E-07	8.74E-03	0	0	0	0	7.12E-02

Table 4A-3. SDA Trench 3 Radionuclide Inventory (Page 4 of 4)

Nuclide	Curies per Trench Interval (feet from North end)										Total
	400 - 449	450 - 499	500 - 549	550 - 599	600 - 649	650 - 699	700 - 750				
Rn-222	6.32E-13	6.25E-13	4.60E-03	1.18E-02	8.30E-08	2.90E-01	0	0	0	0	4.31E-01
Ra-223	2.01E-07	9.95E-10	1.40E-06	9.42E-08	6.09E-07	1.06E-06	0	0	0	0	9.69E-06
Ra-224	0	0	3.34E-08	3.02E-07	1.34E-07	8.74E-03	0	0	0	0	7.12E-02
Ra-226	6.33E-13	6.26E-13	4.60E-03	1.18E-02	8.31E-08	2.90E-01	0	0	0	0	4.31E-01
Ra-228	0	0	4.63E-11	4.18E-10	1.86E-10	8.81E-03	0	0	0	0	7.18E-02
Ac-227	2.02E-07	1.00E-09	1.41E-06	9.47E-08	6.12E-07	1.07E-06	0	0	0	0	9.74E-06
Ac-228	0	0	4.63E-11	4.18E-10	1.86E-10	8.81E-03	0	0	0	0	7.18E-02
Th-227	1.99E-07	9.83E-10	1.39E-06	9.31E-08	6.02E-07	1.05E-06	0	0	0	0	9.57E-06
Th-228	0	0	3.34E-08	3.02E-07	1.34E-07	8.74E-03	0	0	0	0	7.12E-02
Th-230	1.25E-10	1.23E-10	2.92E-05	3.84E-09	1.12E-05	2.41E-05	0	0	0	0	1.97E-04
Th-231	7.06E-04	3.49E-06	4.92E-03	3.21E-04	2.13E-03	3.72E-03	0	0	0	0	3.32E-02
Th-232	5.54E-21	5.49E-21	4.68E-11	4.23E-10	1.88E-10	8.95E-03	0	0	0	0	7.29E-02
Th-234	2.80E-05	2.74E-05	1.07E-01	2.52E-03	3.98E-02	7.92E-02	0	0	0	0	5.06E-01
Pa-231	5.15E-07	2.55E-09	3.59E-06	2.38E-07	1.56E-06	2.71E-06	0	0	0	0	2.46E-05
Pa-234m	2.80E-05	2.74E-05	1.07E-01	2.52E-03	3.98E-02	7.92E-02	0	0	0	0	5.06E-01
U-233	6.00E-12	5.93E-12	7.30E-08	6.59E-07	2.93E-07	5.17E-07	0	0	0	0	1.55E-06
U-234	7.69E-07	7.60E-07	9.39E-02	2.36E-05	3.60E-02	7.77E-02	0	0	0	0	6.26E-01
U-235	7.06E-04	3.49E-06	4.92E-03	3.21E-04	2.13E-03	3.72E-03	0	0	0	0	3.32E-02
U-238	2.80E-05	2.74E-05	1.07E-01	2.52E-03	3.98E-02	7.92E-02	0	0	0	0	5.06E-01
Pu-238	6.81E-03	6.74E-03	4.00E-02	2.08E-01	2.25E-01	6.36E-02	0	0	0	0	2.28E+00
Pu-239	4.40E-03	4.35E-03	2.88E-02	1.65E-01	7.59E+00	4.86E-02	0	0	0	0	1.03E+01
Pu-240	1.43E-05	1.42E-05	7.21E-05	3.76E-04	3.77E-04	3.18E-02	0	0	0	0	9.28E-01
Pu-241	4.09E-02	4.04E-02	2.76E-01	1.44E+00	1.60E+00	9.83E-01	0	0	0	0	3.23E+01
Am-241	9.82E-03	9.70E-03	6.73E-02	3.57E-01	4.01E-01	1.53E-01	0	0	0	0	5.44E+00
Cm-242	0	0	9.02E-09	8.15E-08	3.63E-08	6.40E-08	0	0	0	0	1.91E-07
Total	17.43	17.27	183.04	386.46	358.52	204.15	0	0	0	0	2,956.50

Table 4A-4. SDA Trench 4 Radionuclide Inventory (Page 1 of 4)

Nuclide	Curies per Trench Interval (feet from North end)									
	0 - 49	50 - 99	100 - 149	150 - 199	200 - 249	250 - 299	300 - 349	350 - 399		
H-3	5.20E+01	1.77E+02	1.09E+02	2.01E+01	5.76E+01	1.40E+02	2.81E+02	1.32E+01		
C-14	1.49E+01	1.40E+01	4.98E+00	5.05E+00	1.62E+01	4.78E+00	8.18E+00	3.65E+00		
Fe-55	6.60E-02	4.80E-02	1.89E-02	3.60E-01	2.91E-01	1.23E-01	4.10E-02	6.77E-02		
Co-60	9.10E+00	6.48E+00	2.39E+00	4.04E+01	3.34E+01	1.22E+01	5.00E+00	7.79E+00		
Ni-59	5.17E-01	3.45E-01	1.20E-01	2.03E+00	1.69E+00	1.24E+00	2.52E-01	3.92E-01		
Ni-63	1.01E+02	8.41E+01	2.61E+01	6.02E+01	1.19E+02	4.75E+01	4.14E+01	2.81E+01		
Kr-85	0	0	0	0	0	0	0	0		
Sr-90	1.16E+01	1.01E+01	3.15E+00	4.03E+00	1.24E+01	2.99E+00	4.86E+00	2.86E+00		
Y-90	1.16E+01	1.01E+01	3.15E+00	4.03E+00	1.24E+01	2.99E+00	4.86E+00	2.86E+00		
Zr-93	2.10E-07	3.53E-07	1.88E-09	1.35E-07	6.65E-09	3.23E-08	1.25E-08	2.91E-07		
Nb-94	1.64E-02	1.09E-02	3.81E-03	6.42E-02	5.33E-02	1.64E-02	7.97E-03	1.24E-02		
Tc-99	1.17E-01	9.48E-02	2.97E-02	9.19E-02	1.49E-01	3.93E-02	4.79E-02	3.53E-02		
I-129	3.44E-01	2.81E-01	8.76E-02	2.53E-01	4.29E-01	1.11E-01	1.41E-01	1.02E-01		
Cs-135	1.17E-01	9.49E-02	2.97E-02	9.19E-02	1.49E-01	3.90E-02	4.79E-02	3.53E-02		
Cs-137	1.41E+03	1.16E+03	3.66E+02	1.13E+03	1.84E+03	4.81E+02	5.90E+02	4.35E+02		
Ba-137m	1.33E+03	1.09E+03	3.46E+02	1.07E+03	1.74E+03	4.55E+02	5.58E+02	4.11E+02		
Pm-147	1.92E-06	3.65E-06	2.09E-08	1.51E-06	7.42E-08	4.20E-07	1.40E-07	3.25E-06		
Ti-207	1.13E-05	2.72E-06	1.41E-06	4.20E-06	3.14E-06	2.85E-05	6.90E-05	5.04E-07		
Ti-208	3.52E-07	5.95E-07	8.67E-03	2.29E-07	1.13E-08	5.50E-08	2.12E-08	6.62E-05		
Pb-210	1.97E-03	2.09E-04	8.77E-04	7.83E-02	6.02E-02	1.00E+00	4.50E-06	2.67E-09		
Pb-211	1.13E-05	2.73E-06	1.41E-06	4.21E-06	3.15E-06	2.86E-05	6.92E-05	5.05E-07		
Pb-212	9.80E-07	1.66E-06	2.41E-02	6.37E-07	3.13E-08	1.53E-07	5.89E-08	1.84E-04		
Pb-214	3.02E-03	3.21E-04	1.35E-03	1.20E-01	9.25E-02	1.54E+00	1.65E-05	9.82E-09		
Bi-210	1.97E-03	2.09E-04	8.77E-04	7.83E-02	6.02E-02	1.00E+00	4.49E-06	2.66E-09		
Bi-211	1.13E-05	2.73E-06	1.41E-06	4.21E-06	3.15E-06	2.86E-05	6.92E-05	5.05E-07		
Bi-212	9.80E-07	1.66E-06	2.41E-02	6.37E-07	3.13E-08	1.53E-07	5.89E-08	1.84E-04		
Bi-214	3.02E-03	3.21E-04	1.35E-03	1.20E-01	9.25E-02	1.54E+00	1.65E-05	9.82E-09		
Po-210	1.95E-03	2.07E-04	8.69E-04	7.75E-02	5.97E-02	9.92E-01	4.29E-06	2.54E-09		
Po-212	0	0	1.55E-02	0	0	0	0	0		
Po-214	3.02E-03	3.21E-04	1.35E-03	1.20E-01	9.25E-02	1.54E+00	1.65E-05	9.82E-09		
Po-215	1.13E-05	2.73E-06	1.41E-06	4.21E-06	3.15E-06	2.86E-05	6.92E-05	5.05E-07		
Po-216	9.80E-07	1.66E-06	2.41E-02	6.37E-07	3.13E-08	1.53E-07	5.89E-08	1.84E-04		
Po-218	3.02E-03	3.21E-04	1.35E-03	1.20E-01	9.25E-02	1.54E+00	1.65E-05	9.82E-09		
Rn-219	1.13E-05	2.73E-06	1.41E-06	4.21E-06	3.15E-06	2.86E-05	6.92E-05	5.05E-07		
Rn-220	9.80E-07	1.66E-06	2.41E-02	6.37E-07	3.13E-08	1.53E-07	5.89E-08	1.84E-04		

Table 4A-4. SDA Trench 4 Radionuclide Inventory (Page 2 of 4)

Nuclide	Curies per Trench Interval (feet from North end)									
	0 - 49	50 - 99	100 - 149	150 - 199	200 - 249	250 - 299	300 - 349	350 - 399		
Rn-222	3.02E-03	3.21E-04	1.35E-03	1.20E-01	9.25E-02	1.54E+00	1.65E-05	9.83E-09		
Ra-223	1.13E-05	2.73E-06	1.41E-06	4.21E-06	3.15E-06	2.86E-05	6.92E-05	5.05E-07		
Ra-224	9.80E-07	1.66E-06	2.41E-02	6.37E-07	3.13E-08	1.53E-07	5.89E-08	1.84E-04		
Ra-226	3.02E-03	3.21E-04	1.35E-03	1.20E-01	9.25E-02	1.54E+00	1.65E-05	9.83E-09		
Ra-228	1.36E-09	2.28E-09	2.44E-02	8.74E-10	4.30E-11	2.09E-10	8.08E-11	1.85E-04		
Ac-227	1.14E-05	2.74E-06	1.42E-06	4.24E-06	3.17E-06	2.87E-05	6.96E-05	5.08E-07		
Ac-228	1.36E-09	2.28E-09	2.44E-02	8.74E-10	4.30E-11	2.09E-10	8.08E-11	1.85E-04		
Th-227	1.12E-05	2.69E-06	1.40E-06	4.16E-06	3.11E-06	2.82E-05	6.84E-05	5.00E-07		
Th-228	9.80E-07	1.66E-06	2.41E-02	6.37E-07	3.13E-08	1.53E-07	5.89E-08	1.84E-04		
Th-230	2.08E-04	2.34E-05	2.24E-05	7.13E-05	4.39E-05	9.44E-04	2.28E-03	1.38E-06		
Th-231	4.15E-02	9.66E-03	5.22E-03	1.55E-02	1.16E-02	1.05E-01	2.55E-01	1.82E-03		
Th-232	1.37E-09	2.30E-09	2.48E-02	8.85E-10	4.35E-11	2.11E-10	8.18E-11	1.88E-04		
Th-234	6.97E-01	1.19E-01	8.89E-02	2.61E-01	1.38E-01	7.13E+00	1.70E+01	1.71E-02		
Pa-231	2.95E-05	7.00E-06	3.69E-06	1.10E-05	8.23E-06	7.46E-05	1.81E-04	1.31E-06		
Pa-234m	6.97E-01	1.19E-01	8.89E-02	2.61E-01	1.38E-01	7.13E+00	1.70E+01	1.71E-02		
U-233	2.14E-06	3.60E-06	2.00E-08	1.38E-06	7.51E-08	3.31E-07	1.29E-07	2.97E-06		
U-234	6.90E-01	7.58E-02	7.45E-02	2.37E-01	1.46E-01	3.13E+00	7.57E+00	4.80E-03		
U-235	4.15E-02	9.66E-03	5.22E-03	1.55E-02	1.16E-02	1.05E-01	2.55E-01	1.82E-03		
U-238	6.97E-01	1.19E-01	8.89E-02	2.61E-01	1.38E-01	7.13E+00	1.70E+01	1.71E-02		
Pu-238	2.75E+00	6.52E+00	7.11E-01	4.40E+00	6.89E+00	1.43E+00	1.23E+00	4.00E+00		
Pu-239	2.52E+00	5.68E+00	6.21E+00	2.93E+00	5.43E+00	1.07E+00	1.09E+00	3.29E+00		
Pu-240	3.95E-03	3.78E+00	9.82E-04	1.08E-02	1.56E+00	3.03E-03	1.88E-03	2.49E+00		
Pu-241	2.10E+01	1.16E+02	5.65E+00	2.79E+01	7.76E+01	9.82E+00	9.54E+00	7.51E+01		
Am-241	5.31E+00	1.76E+01	1.36E+00	6.99E+00	1.42E+01	2.43E+00	2.31E+00	1.07E+01		
Cm-242	2.64E-07	4.46E-07	2.38E-09	1.71E-07	8.42E-09	4.11E-08	1.58E-08	3.69E-07		
Total	2,973.83	2,703.60	875.15	2,381.20	3,940.17	1,200.29	1,567.30	1,001.21		

Table 4A-4. SDA Trench 4 Radionuclide Inventory (Page 3 of 4)

Nuclide	Curies per Trench Interval (feet from North end)										Total
	400 - 449	450 - 499	500 - 549	550 - 599	600 - 649	650 - 699	700 - 750				
H-3	4.44E+00	5.87E+02	1.37E+03	0	0	0	1.37E+00	0	0	0	2.82E+03
C-14	1.28E+00	3.57E+00	9.30E+00	0	0	0	4.03E-01	0	0	0	8.63E+01
Fe-55	6.29E-02	5.04E-01	2.20E+00	0	0	0	3.36E-02	0	0	0	3.81E+00
Co-60	7.05E+00	3.12E+01	1.20E+02	0	0	0	3.31E+00	0	0	0	2.79E+02
Ni-59	3.56E-01	7.32E+00	3.65E+01	0	0	0	1.46E-01	0	0	0	5.09E+01
Ni-63	1.28E+01	1.75E+02	8.92E+02	0	0	0	4.09E+00	0	0	0	1.59E+03
Kr-85	0	0	0	0	0	0	0	0	0	0	0
Sr-90	1.04E+00	3.12E-01	1.64E+00	0	0	0	3.47E-01	0	0	0	5.53E+01
Y-90	1.04E+00	3.12E-01	1.64E+00	0	0	0	3.47E-01	0	0	0	5.53E+01
Zr-93	2.23E-06	6.62E-07	1.18E-06	0	0	0	8.94E-08	0	0	0	5.20E-06
Nb-94	1.12E-02	1.41E-02	1.31E-02	0	0	0	4.62E-03	0	0	0	2.28E-01
Tc-99	1.85E-02	1.62E-02	3.23E-02	0	0	0	7.87E-03	0	0	0	6.80E-01
I-129	5.15E-02	3.59E-02	5.05E-02	0	0	0	2.15E-02	0	0	0	1.91E+00
Cs-135	1.85E-02	1.34E-02	1.74E-02	0	0	0	8.01E-03	0	0	0	6.62E-01
Cs-137	2.28E+02	1.69E+02	2.19E+02	0	0	0	9.92E+01	0	0	0	8.12E+03
Ba-137m	2.16E+02	1.60E+02	2.08E+02	0	0	0	9.39E+01	0	0	0	7.68E+03
Pm-147	3.23E-05	9.62E-06	1.72E-05	0	0	0	1.30E-06	0	0	0	7.14E-05
Ti-207	7.56E-06	6.23E-05	3.88E-05	3.62E-02	2.57E-01	0	1.65E-01	0	0	0	4.58E-01
Ti-208	3.80E-06	1.13E-06	2.02E-06	0	0	0	1.53E-07	0	0	0	8.75E-03
Pb-210	3.33E-07	6.21E-03	1.06E-04	7.77E-01	5.51E+00	0	3.53E+00	0	0	0	1.10E+01
Pb-211	7.58E-06	6.25E-05	3.89E-05	3.63E-02	2.58E-01	0	1.65E-01	0	0	0	4.59E-01
Pb-212	1.06E-05	3.15E-06	5.63E-06	0	0	0	4.25E-07	0	0	0	2.44E-02
Pb-214	1.22E-06	9.72E-03	1.71E-04	7.77E-01	5.51E+00	0	3.53E+00	0	0	0	1.16E+01
Bi-210	3.32E-07	6.21E-03	1.06E-04	7.77E-01	5.51E+00	0	3.53E+00	0	0	0	1.10E+01
Bi-211	7.58E-06	6.25E-05	3.89E-05	3.63E-02	2.58E-01	0	1.65E-01	0	0	0	4.59E-01
Bi-212	1.06E-05	3.15E-06	5.63E-06	0	0	0	4.25E-07	0	0	0	2.44E-02
Bi-214	1.22E-06	9.72E-03	1.71E-04	7.77E-01	5.51E+00	0	3.53E+00	0	0	0	1.16E+01
Po-210	3.18E-07	6.15E-03	1.05E-04	7.77E-01	5.51E+00	0	3.53E+00	0	0	0	1.10E+01
Po-212	0	0	0	0	0	0	0	0	0	0	1.55E-02
Po-214	0	9.71E-03	1.71E-04	7.77E-01	5.51E+00	0	3.53E+00	0	0	0	1.16E+01
Po-215	7.58E-06	6.25E-05	3.89E-05	3.63E-02	2.58E-01	0	1.65E-01	0	0	0	4.59E-01
Po-216	1.06E-05	3.15E-06	5.63E-06	0	0	0	4.25E-07	0	0	0	2.44E-02
Po-218	1.22E-06	9.72E-03	1.71E-04	7.77E-01	5.51E+00	0	3.53E+00	0	0	0	1.16E+01
Rn-219	7.58E-06	6.25E-05	3.89E-05	3.63E-02	2.58E-01	0	1.65E-01	0	0	0	4.59E-01
Rn-220	1.06E-05	3.15E-06	5.63E-06	0	0	0	4.25E-07	0	0	0	2.44E-02

Table 4A-4. SDA Trench 4 Radionuclide Inventory (Page 4 of 4)

Nuclide	Curies per Trench Interval (feet from North end)										Total
	400 - 449	450 - 499	500 - 549	550 - 599	600 - 649	650 - 699	700 - 750				
Rn-222	1.22E-06	9.72E-03	1.71E-04	7.77E-01	5.51E+00	3.53E+00	0	0	0	0	1.16E+01
Ra-223	7.58E-06	6.25E-05	3.89E-05	3.63E-02	2.58E-01	1.65E-01	0	0	0	0	4.59E-01
Ra-224	1.06E-05	3.15E-06	5.63E-06	0	0	4.25E-07	0	0	0	0	2.44E-02
Ra-226	1.22E-06	9.72E-03	1.71E-04	7.77E-01	5.51E+00	3.53E+00	0	0	0	0	1.16E+01
Ra-228	1.44E-08	4.27E-09	7.64E-09	0	0	5.77E-10	0	0	0	0	2.45E-02
Ac-227	7.62E-06	6.29E-05	3.91E-05	3.63E-02	2.58E-01	1.65E-01	0	0	0	0	4.59E-01
Ac-228	1.44E-08	4.27E-09	7.64E-09	0	0	5.77E-10	0	0	0	0	2.45E-02
Th-227	7.49E-06	6.18E-05	3.85E-05	3.58E-02	2.54E-01	1.63E-01	0	0	0	0	4.53E-01
Th-228	1.06E-05	3.15E-06	5.63E-06	0	0	4.25E-07	0	0	0	0	2.44E-02
Th-230	1.70E-04	1.78E-03	1.33E-03	7.77E-01	5.51E+00	3.53E+00	0	0	0	0	9.83E+00
Th-231	2.78E-02	2.43E-01	1.51E-01	3.61E-02	2.56E-01	2.13E-01	0	0	0	0	1.37E+00
Th-232	1.46E-08	4.33E-09	7.74E-09	0	0	5.84E-10	0	0	0	0	2.50E-02
Th-234	5.59E-01	1.03E+01	1.04E+01	7.77E-01	5.51E+00	6.27E+00	0	0	0	0	5.92E+01
Pa-231	1.98E-05	1.67E-04	1.04E-04	3.63E-02	2.58E-01	1.65E-01	0	0	0	0	4.60E-01
Pa-234m	5.59E-01	1.03E+01	1.04E+01	7.77E-01	5.51E+00	6.27E+00	0	0	0	0	5.92E+01
U-233	2.27E-05	6.75E-06	1.21E-05	0	0	9.11E-07	0	0	0	0	5.31E-05
U-234	5.67E-01	6.08E+00	4.55E+00	7.77E-01	5.51E+00	4.72E+00	0	0	0	0	3.41E+01
U-235	2.78E-02	2.43E-01	1.51E-01	3.61E-02	2.56E-01	2.13E-01	0	0	0	0	1.37E+00
U-238	5.59E-01	1.03E+01	1.04E+01	7.77E-01	5.51E+00	6.27E+00	0	0	0	0	5.92E+01
Pu-238	8.03E-01	7.85E-01	2.12E+00	0	0	1.03E-01	0	0	0	0	3.18E+01
Pu-239	5.53E-01	4.88E-01	1.77E+00	0	0	7.79E-02	0	0	0	0	3.11E+01
Pu-240	2.61E-03	2.23E-03	1.46E+00	0	0	2.07E-04	0	0	0	0	9.32E+00
Pu-241	5.22E+00	4.97E+00	4.47E+01	0	0	7.52E-01	0	0	0	0	3.98E+02
Am-241	1.30E+00	1.19E+00	5.84E+00	0	0	1.67E-01	0	0	0	0	6.94E+01
Cm-242	2.83E-06	8.42E-07	1.51E-06	0	0	1.14E-07	0	0	0	0	6.61E-06
Total	481.83	1,178.58	2,956.36	11.28	80.00	265.07	0	0	0	0	21,615.88

Table 4A-5. SDA Trench 5 Radionuclide Inventory (Page 1 of 4)

Nuclide	Curies per Trench Interval (feet from North end)									
	0 - 49	50 - 99	100 - 149	150 - 199	200 - 249	250 - 299	300 - 349	350 - 399		
H-3	1.10E+02	4.08E-03	4.77E+02	2.09E+02	3.21E-01	8.67E+02	5.69E+02	6.59E+02		
C-14	4.05E+00	1.02E-03	2.82E+00	1.24E+00	1.10E-01	4.71E+00	3.23E+00	3.81E+00		
Fe-55	2.07E+00	2.32E-05	4.53E-04	1.79E-04	3.06E-03	3.09E-04	3.17E-02	1.18E-01		
Co-60	1.22E+02	2.61E-03	5.21E-02	2.10E-02	3.04E-01	5.03E-02	2.76E+00	1.02E+01		
Ni-59	3.19E+01	1.15E-04	2.04E-03	8.28E-04	1.33E-02	1.10E-03	1.07E-01	3.96E-01		
Ni-63	7.82E+02	2.84E-02	1.71E-01	1.08E-01	3.26E-01	1.17E-01	2.72E+00	7.05E+00		
Kr-85	0	0	0	0	0	2.56E-01	0	0		
Sr-90	3.34E+00	1.80E-03	6.78E-02	4.35E-02	4.60E-02	9.12E-01	1.56E-01	2.75E-01		
Y-90	3.34E+00	1.80E-03	6.78E-02	4.35E-02	4.60E-02	9.12E-01	1.56E-01	2.75E-01		
Zr-93	6.56E-08	5.32E-08	3.78E-07	2.89E-07	2.15E-07	1.01E-06	1.61E-06	5.45E-07		
Nb-94	3.92E-02	3.64E-06	6.44E-05	2.62E-05	4.21E-04	3.46E-05	3.37E-03	1.25E-02		
Tc-99	7.54E-02	8.40E-06	1.68E-04	1.06E-04	6.66E-04	1.20E-04	3.68E-03	1.29E-02		
I-129	1.74E-01	2.34E-05	4.68E-04	3.01E-04	1.80E-03	3.23E-04	9.84E-03	3.43E-02		
Cs-135	6.37E-02	7.93E-06	1.66E-04	1.04E-04	6.78E-04	1.13E-04	3.67E-03	1.29E-02		
Cs-137	7.91E+02	1.01E-01	2.18E+00	1.35E+00	8.43E+00	1.78E+00	4.74E+01	1.66E+02		
Ba-137m	7.49E+02	9.55E-02	2.06E+00	1.28E+00	7.97E+00	1.68E+00	4.48E+01	1.57E+02		
Pm-147	9.53E-07	7.73E-07	5.48E-06	4.20E-06	3.88E-06	4.09E-03	3.05E-05	1.03E-05		
Ti-207	9.38E-07	5.10E-02	1.32E-02	1.56E-06	2.96E-02	1.52E-06	4.66E-06	2.48E-06		
Ti-208	1.12E-07	9.10E-08	3.09E-04	1.73E-03	2.56E-03	9.02E-02	6.84E-03	4.57E-02		
Pb-210	3.13E-03	1.10E+00	2.83E-01	1.13E-02	6.38E-01	2.58E-03	3.49E-01	7.00E-02		
Pb-211	9.41E-07	5.12E-02	1.32E-02	1.57E-06	2.97E-02	1.53E-06	4.67E-06	2.49E-06		
Pb-212	3.12E-07	2.53E-07	8.60E-04	4.82E-03	7.12E-03	2.51E-01	1.90E-02	1.27E-01		
Pb-214	4.89E-03	1.10E+00	2.83E-01	1.77E-02	6.40E-01	4.10E-03	5.55E-01	1.11E-01		
Bi-210	3.13E-03	1.10E+00	2.83E-01	1.13E-02	6.38E-01	2.58E-03	3.49E-01	7.00E-02		
Bi-211	9.41E-07	5.12E-02	1.32E-02	1.57E-06	2.97E-02	1.53E-06	4.67E-06	2.49E-06		
Bi-212	3.12E-07	2.53E-07	8.60E-04	4.82E-03	7.12E-03	2.51E-01	1.90E-02	1.27E-01		
Bi-214	4.89E-03	1.10E+00	2.83E-01	1.77E-02	6.40E-01	4.10E-03	5.55E-01	1.11E-01		
Po-210	3.10E-03	1.10E+00	2.83E-01	1.12E-02	6.38E-01	2.55E-03	3.45E-01	6.93E-02		
Po-212	0	0	0	0	0	1.61E-01	1.22E-02	8.15E-02		
Po-214	4.89E-03	1.10E+00	2.83E-01	1.77E-02	6.40E-01	4.10E-03	5.55E-01	1.11E-01		
Po-215	0	5.12E-02	1.32E-02	1.57E-06	2.97E-02	1.53E-06	4.67E-06	2.49E-06		
Po-216	3.12E-07	2.53E-07	8.60E-04	4.82E-03	7.12E-03	2.51E-01	1.90E-02	1.27E-01		
Po-218	4.90E-03	1.10E+00	2.83E-01	1.77E-02	6.40E-01	4.10E-03	5.55E-01	1.11E-01		
Rn-219	9.41E-07	5.12E-02	1.32E-02	1.57E-06	2.97E-02	1.53E-06	4.67E-06	2.49E-06		
Rn-220	3.12E-07	2.53E-07	8.60E-04	4.82E-03	7.12E-03	2.51E-01	1.90E-02	1.27E-01		

Table 4A-5. SDA Trench 5 Radionuclide Inventory (Page 2 of 4)

Nuclide	Curies per Trench Interval (feet from North end)									
	0 - 49	50 - 99	100 - 149	150 - 199	200 - 249	250 - 299	300 - 349	350 - 399		
Rn-222	4.90E-03	1.10E+00	2.83E-01	1.77E-02	6.40E-01	4.10E-03	5.55E-01	1.11E-01		
Ra-223	9.41E-07	5.12E-02	1.32E-02	1.57E-06	2.97E-02	1.53E-06	4.67E-06	2.49E-06		
Ra-224	3.12E-07	2.53E-07	8.60E-04	4.82E-03	7.12E-03	2.51E-01	1.90E-02	1.27E-01		
Ra-226	4.90E-03	1.10E+00	2.83E-01	1.77E-02	6.40E-01	4.10E-03	5.55E-01	1.11E-01		
Ra-228	4.23E-10	3.43E-10	8.67E-04	4.87E-03	7.20E-03	2.54E-01	1.92E-02	1.29E-01		
Ac-227	9.47E-07	5.12E-02	1.32E-02	1.58E-06	2.97E-02	1.54E-06	4.70E-06	2.50E-06		
Ac-228	4.23E-10	3.43E-10	8.67E-04	4.87E-03	7.20E-03	2.54E-01	1.92E-02	1.29E-01		
Th-227	9.30E-07	5.05E-02	1.30E-02	1.55E-06	2.93E-02	1.51E-06	4.62E-06	2.46E-06		
Th-228	3.12E-07	2.53E-07	8.60E-04	4.82E-03	7.12E-03	2.51E-01	1.90E-02	1.27E-01		
Th-230	1.37E-05	1.10E+00	2.83E-01	3.45E-05	6.36E-01	4.01E-05	1.45E-04	7.80E-05		
Th-231	3.69E-03	5.09E-02	4.94E-02	6.04E-03	5.53E-02	6.09E-03	1.89E-02	1.01E-02		
Th-232	4.29E-10	3.48E-10	8.85E-04	4.97E-03	7.36E-03	2.60E-01	1.97E-02	1.32E-01		
Th-234	8.75E-02	1.10E+00	2.51E+00	1.48E-01	2.44E+00	1.93E-01	1.08E+00	6.15E-01		
Pa-231	2.52E-06	5.12E-02	1.32E-02	4.17E-06	2.97E-02	4.12E-06	1.27E-05	6.76E-06		
Pa-234m	8.75E-02	1.10E+00	2.51E+00	1.48E-01	2.44E+00	1.93E-01	1.08E+00	6.15E-01		
U-233	6.70E-07	5.42E-07	3.85E-06	2.95E-06	2.19E-06	1.03E-05	1.64E-05	5.55E-06		
U-234	5.52E-02	1.10E+00	1.32E+00	1.18E-01	1.42E+00	1.42E-01	5.12E-01	2.75E-01		
U-235	3.69E-03	5.09E-02	4.94E-02	6.04E-03	5.53E-02	6.09E-03	1.89E-02	1.01E-02		
U-238	8.75E-02	1.10E+00	2.51E+00	1.48E-01	2.44E+00	1.93E-01	1.08E+00	6.15E-01		
Pu-238	1.64E+02	2.44E-04	3.31E-03	2.40E-03	8.68E-01	1.49E+00	2.10E-01	7.62E-01		
Pu-239	1.50E+00	2.00E-04	2.83E-03	1.24E-01	7.24E-01	1.24E+00	3.72E+00	9.79E+00		
Pu-240	7.88E-01	1.76E-05	1.27E-04	9.72E-05	7.59E-01	1.31E+00	1.04E-03	2.11E-03		
Pu-241	2.92E+01	2.56E-03	2.98E-02	2.21E-02	2.14E+01	3.78E+01	1.41E+00	4.97E+00		
Am-241	4.29E+00	5.15E-04	6.45E-03	4.77E-03	2.61E+00	4.47E+00	3.17E-01	1.13E+00		
Cm-242	8.34E-08	6.77E-08	4.80E-07	3.68E-07	2.75E-07	1.29E-06	2.06E-06	6.96E-07		
Total	2,799.42	16.14	496.23	214.28	59.49	926.55	684.53	1,025.72		

Table 4A-5. SDA Trench 5 Radionuclide Inventory (Page 3 of 4)

Nuclide	Curies per Trench Interval (feet from North end)										Total	
	400 - 449	450 - 499	500 - 549	550 - 599	600 - 649	650 - 699	700 - 750					
H-3	7.81E+02	4.86E-01	8.00E+01	1.17E+00	0	0	0	0	0	0	0	3.75E+03
C-14	4.49E+00	5.75E-03	3.11E-01	1.39E-02	0	0	0	0	0	0	0	2.48E+01
Fe-55	4.77E+00	8.58E-04	9.14E-04	2.19E-02	0	0	0	0	0	0	0	7.02E+00
Co-60	2.62E+02	6.84E-02	8.89E-02	1.19E+00	0	0	0	0	0	0	0	4.00E+02
Ni-59	7.85E+01	2.44E-03	3.10E-03	3.68E-01	0	0	0	0	0	0	0	1.11E+02
Ni-63	1.89E+03	5.07E-02	1.00E-01	8.88E+00	0	0	0	0	0	0	0	2.69E+03
Kr-85	0	0	0	0	0	0	0	0	0	0	0	2.56E-01
Sr-90	3.69E-01	3.67E-03	8.85E-02	5.48E-03	0	0	0	0	0	0	0	5.30E+00
Y-90	3.69E-01	3.67E-03	8.85E-02	5.48E-03	0	0	0	0	0	0	0	5.31E+00
Zr-93	1.14E-07	3.22E-08	1.32E-07	3.05E-08	0	0	0	0	0	0	0	4.47E-06
Nb-94	3.11E-02	7.71E-05	9.80E-05	8.77E-05	0	0	0	0	0	0	0	8.70E-02
Tc-99	4.46E-02	1.08E-04	1.63E-04	1.51E-04	0	0	0	0	0	0	0	1.38E-01
I-129	3.36E-02	2.88E-04	4.43E-04	4.38E-10	0	0	0	0	0	0	0	2.55E-01
Cs-135	1.26E-02	1.10E-04	1.65E-04	8.65E-09	0	0	0	0	0	0	0	9.43E-02
Cs-137	1.63E+02	1.41E+00	2.23E+00	6.02E-03	0	0	0	0	0	0	0	1.19E+03
Ba-137m	1.55E+02	1.34E+00	2.11E+00	5.69E-03	0	0	0	0	0	0	0	1.12E+03
Pm-147	2.67E-06	7.05E-07	2.50E-06	5.39E-07	0	0	0	0	0	0	0	4.16E-03
Ti-207	2.71E-06	1.47E-09	1.24E-06	1.10E-06	0	0	0	0	0	0	0	9.39E-02
Ti-208	6.79E-02	5.59E-08	2.28E-07	5.24E-08	0	0	0	0	0	0	0	2.15E-01
Pb-210	2.79E-02	5.52E-14	9.42E-03	6.91E-08	0	0	0	0	0	0	0	2.49E+00
Pb-211	2.71E-06	1.47E-09	1.25E-06	1.10E-06	0	0	0	0	0	0	0	9.41E-02
Pb-212	1.89E-01	1.56E-07	6.34E-07	1.46E-07	0	0	0	0	0	0	0	5.99E-01
Pb-214	4.53E-02	0	1.50E-02	2.65E-07	0	0	0	0	0	0	0	2.77E+00
Bi-210	2.79E-02	5.51E-14	9.42E-03	6.90E-08	0	0	0	0	0	0	0	2.49E+00
Bi-211	2.71E-06	1.47E-09	1.25E-06	1.10E-06	0	0	0	0	0	0	0	9.41E-02
Bi-212	1.89E-01	1.56E-07	6.34E-07	1.46E-07	0	0	0	0	0	0	0	5.99E-01
Bi-214	4.53E-02	0	1.50E-02	2.65E-07	0	0	0	0	0	0	0	2.77E+00
Po-210	2.76E-02	5.30E-14	9.32E-03	6.57E-08	0	0	0	0	0	0	0	2.48E+00
Po-212	1.21E-01	0	0	0	0	0	0	0	0	0	0	3.76E-01
Po-214	4.53E-02	0	1.50E-02	0	0	0	0	0	0	0	0	2.77E+00
Po-215	2.71E-06	0	1.25E-06	1.10E-06	0	0	0	0	0	0	0	9.41E-02
Po-216	1.89E-01	1.56E-07	6.34E-07	1.46E-07	0	0	0	0	0	0	0	5.99E-01
Po-218	4.53E-02	0	1.50E-02	2.65E-07	0	0	0	0	0	0	0	2.77E+00
Rn-219	2.71E-06	1.47E-09	1.25E-06	1.10E-06	0	0	0	0	0	0	0	9.41E-02
Rn-220	1.89E-01	1.56E-07	6.34E-07	1.46E-07	0	0	0	0	0	0	0	5.99E-01

Table 4A-5. SDA Trench 5 Radionuclide Inventory (Page 4 of 4)

Nuclide	Curies per Trench Interval (feet from North end)										Total
	400 - 449	450 - 499	500 - 549	550 - 599	600 - 649	650 - 699	700 - 750				
Rn-222	4.53E-02	1.81E-13	1.50E-02	2.65E-07	0	0	0	0	0	0	2.77E+00
Ra-223	2.71E-06	1.47E-09	1.25E-06	1.10E-06	0	0	0	0	0	0	9.41E-02
Ra-224	1.89E-01	1.56E-07	6.34E-07	1.46E-07	0	0	0	0	0	0	5.99E-01
Ra-226	4.53E-02	1.82E-13	1.50E-02	2.66E-07	0	0	0	0	0	0	2.77E+00
Ra-228	1.91E-01	2.07E-10	8.50E-10	1.96E-10	0	0	0	0	0	0	6.06E-01
Ac-227	2.73E-06	1.48E-09	1.26E-06	1.11E-06	0	0	0	0	0	0	9.41E-02
Ac-228	1.91E-01	2.07E-10	8.50E-10	1.96E-10	0	0	0	0	0	0	6.06E-01
Th-227	2.68E-06	1.45E-09	1.23E-06	1.09E-06	0	0	0	0	0	0	9.28E-02
Th-228	1.89E-01	1.56E-07	6.33E-07	1.46E-07	0	0	0	0	0	0	5.99E-01
Th-230	7.63E-05	2.61E-11	4.29E-05	3.91E-05	0	0	0	0	0	0	2.02E+00
Th-231	1.11E-02	7.44E-07	5.09E-03	4.52E-03	0	0	0	0	0	0	2.21E-01
Th-232	1.96E-01	2.11E-10	8.62E-10	1.99E-10	0	0	0	0	0	0	6.21E-01
Th-234	5.36E-01	5.85E-06	3.46E-01	3.17E-01	0	0	0	0	0	0	9.37E+00
Pa-231	7.41E-06	2.45E-09	3.40E-06	3.01E-06	0	0	0	0	0	0	9.42E-02
Pa-234m	5.36E-01	5.85E-06	3.46E-01	3.17E-01	0	0	0	0	0	0	9.37E+00
U-233	1.17E-06	3.28E-07	1.34E-06	3.12E-07	0	0	0	0	0	0	4.56E-05
U-234	2.69E-01	1.29E-07	1.51E-01	1.38E-01	0	0	0	0	0	0	5.50E+00
U-235	1.11E-02	7.44E-07	5.09E-03	4.52E-03	0	0	0	0	0	0	2.21E-01
U-238	5.36E-01	5.85E-06	3.46E-01	3.17E-01	0	0	0	0	0	0	9.37E+00
Pu-238	2.54E+00	1.14E-03	2.20E-03	1.30E+00	0	0	0	0	0	0	1.71E+02
Pu-239	1.93E+00	7.42E-04	1.65E-03	1.08E+00	0	0	0	0	0	0	2.01E+01
Pu-240	1.54E+00	1.26E-05	4.65E-05	1.14E+00	0	0	0	0	0	0	5.54E+00
Pu-241	5.08E+01	8.38E-03	1.79E-02	3.35E+01	0	0	0	0	0	0	1.79E+02
Am-241	6.35E+00	1.64E-03	3.84E-03	3.84E+00	0	0	0	0	0	0	2.30E+01
Cm-242	1.47E-07	4.13E-08	1.69E-07	3.89E-08	0	0	0	0	0	0	5.71E-06
Total	3,410.00	3.39	86.38	53.61	0	0	0	0	0	0	9,775.72

Table 4A-6. SDA Trench 6 Radionuclide Inventory (Page 1 of 6)

Nuclide	Curies per Special Purpose Burial Hole							
	SPH-01	SPH-02	SPH-03	SPH-04	SPH-05	SPH-06	SPH-07	SPH-08
H-3	6.55E+01	1.54E-01	8.63E-02	1.37E+00	2.17E+02	2.17E+02	1.63E+02	2.38E+02
C-14	1.97E-01	4.63E-04	2.60E-04	4.11E-03	5.52E-01	5.52E-01	4.14E-01	6.04E-01
Fe-55	2.29E+00	5.38E-03	3.02E-03	4.78E-02	1.38E+01	1.38E+01	1.04E+01	1.52E+01
Co-60	8.51E+01	2.00E-01	1.12E-01	1.78E+00	3.54E+02	3.54E+02	2.65E+02	3.87E+02
Ni-59	1.78E+01	4.18E-02	2.34E-02	3.71E-01	4.98E+01	4.98E+01	3.73E+01	5.45E+01
Ni-63	4.38E+02	1.03E+00	5.78E-01	9.14E+00	1.25E+03	1.25E+03	9.39E+02	1.37E+03
Kr-85	0	0	0	0	0	0	0	0
Sr-90	8.00E-03	1.88E-05	1.05E-05	1.67E-04	2.41E-02	2.41E-02	1.81E-02	2.64E-02
Y-90	8.00E-03	1.88E-05	1.05E-05	1.67E-04	2.41E-02	2.41E-02	1.81E-02	2.64E-02
Zr-93	0	0	0	0	0	0	0	0
Nb-94	4.24E-03	9.96E-06	5.59E-06	8.84E-05	1.19E-02	1.19E-02	8.90E-03	1.30E-02
Tc-99	7.28E-03	1.71E-05	9.59E-06	1.52E-04	2.04E-02	2.04E-02	1.53E-02	2.23E-02
I-129	0	0	0	0	0	0	0	0
Cs-135	0	0	0	0	0	0	0	0
Cs-137	2.68E-02	6.29E-05	3.53E-05	5.59E-04	8.03E-02	8.03E-02	6.02E-02	8.79E-02
Ba-137m	2.53E-02	5.95E-05	3.34E-05	5.28E-04	7.60E-02	7.60E-02	5.70E-02	8.32E-02
Pm-147	0	0	0	0	0	0	0	0
Tl-207	0	0	0	0	0	0	0	0
Tl-208	0	0	0	0	0	0	0	0
Pb-210	0	0	0	0	0	0	0	0
Pb-211	0	0	0	0	0	0	0	0
Pb-212	0	0	0	0	0	0	0	0
Pb-214	0	0	0	0	0	0	0	0
Pb-214	0	0	0	0	0	0	0	0
Bi-210	0	0	0	0	0	0	0	0
Bi-211	0	0	0	0	0	0	0	0
Bi-212	0	0	0	0	0	0	0	0
Bi-214	0	0	0	0	0	0	0	0
Po-210	0	0	0	0	0	0	0	0
Po-212	0	0	0	0	0	0	0	0
Po-214	0	0	0	0	0	0	0	0
Po-215	0	0	0	0	0	0	0	0
Po-216	0	0	0	0	0	0	0	0
Po-218	0	0	0	0	0	0	0	0
Rn-219	0	0	0	0	0	0	0	0
Rn-220	0	0	0	0	0	0	0	0

Table 4A-6. SDA Trench 6 Radionuclide Inventory (Page 2 of 6)

Nuclide	Curies per Special Purpose Burial Hole									
	SPH-01	SPH-02	SPH-03	SPH-04	SPH-05	SPH-06	SPH-07	SPH-08		
Rn-222	0	0	0	0	0	0	0	0	0	0
Ra-223	0	0	0	0	0	0	0	0	0	0
Ra-224	0	0	0	0	0	0	0	0	0	0
Ra-226	0	0	0	0	0	0	0	0	0	0
Ra-228	0	0	0	0	0	0	0	0	0	0
Ac-227	0	0	0	0	0	0	0	0	0	0
Ac-228	0	0	0	0	0	0	0	0	0	0
Th-227	0	0	0	0	0	0	0	0	0	0
Th-228	0	0	0	0	0	0	0	0	0	0
Th-230	0	0	0	0	0	0	0	0	0	0
Th-231	0	0	0	0	0	0	0	0	0	0
Th-232	0	0	0	0	0	0	0	0	0	0
Th-234	0	0	0	0	0	0	0	0	0	0
Pa-231	0	0	0	0	0	0	0	0	0	0
Pa-234m	0	0	0	0	0	0	0	0	0	0
U-233	0	0	0	0	0	0	0	0	0	0
U-234	0	0	0	0	0	0	0	0	0	0
U-235	0	0	0	0	0	0	0	0	0	0
U-238	0	0	0	0	0	0	0	0	0	0
Pu-238	0	0	0	0	0	0	0	0	0	0
Pu-239	0	0	0	0	0	0	0	0	0	0
Pu-240	0	0	0	0	0	0	0	0	0	0
Pu-241	0	0	0	0	0	0	0	0	0	0
Am-241	0	0	0	0	0	0	0	0	0	0
Cm-242	0	0	0	0	0	0	0	0	0	0
Total	609.09	1.43	0.80	12.71	1,887.82	1,887.82	1,415.87	2,067.25		

Table 4A-6. SDA Trench 6 Radionuclide Inventory (Page 3 of 6)

Nuclide	Curies per Special Purpose Burial Hole									
	SPH-09	SPH-10	SPH-11	SPH-12	SPH-13	SPH-14	SPH-15	SPH-16		
H-3	2.38E+02	1.40E+02	1.89E+02	3.57E+02	3.25E+02	1.94E-02	7.76E-03	1.40E+02		
C-14	6.04E-01	3.55E-01	4.79E-01	9.07E-01	8.26E-01	4.93E-05	1.97E-05	3.55E-01		
Fe-55	1.52E+01	8.90E+00	1.20E+01	2.27E+01	2.07E+01	1.24E-03	4.95E-04	8.90E+00		
Co-60	3.87E+02	2.27E+02	3.07E+02	5.81E+02	5.29E+02	3.16E-02	1.26E-02	2.27E+02		
Ni-59	5.45E+01	3.20E+01	4.32E+01	8.17E+01	7.45E+01	4.44E-03	1.78E-03	3.20E+01		
Ni-63	1.37E+03	8.05E+02	1.09E+03	2.06E+03	1.87E+03	1.12E-01	4.47E-02	8.05E+02		
Kr-85	0	0	0	0	0	0	0	0		
Sr-90	2.64E-02	1.55E-02	2.09E-02	3.96E-02	3.60E-02	2.15E-06	8.60E-07	1.55E-02		
Y-90	2.64E-02	1.55E-02	2.09E-02	3.96E-02	3.60E-02	2.15E-06	8.60E-07	1.55E-02		
Zr-93	0	0	0	0	0	0	0	0		
Nb-94	1.30E-02	7.62E-03	1.03E-02	1.95E-02	1.78E-02	1.06E-06	4.24E-07	7.63E-03		
Tc-99	2.23E-02	1.31E-02	1.77E-02	3.35E-02	3.05E-02	1.82E-06	7.28E-07	1.31E-02		
I-129	0	0	0	0	0	0	0	0		
Cs-135	0	0	0	0	0	0	0	0		
Cs-137	8.79E-02	5.16E-02	6.97E-02	1.32E-01	1.20E-01	7.17E-06	2.87E-06	5.16E-02		
Ba-137m	8.32E-02	4.88E-02	6.60E-02	1.25E-01	1.14E-01	6.78E-06	2.71E-06	4.88E-02		
Pm-147	0	0	0	0	0	0	0	0		
Tl-207	0	0	0	0	0	0	0	0		
Tl-208	0	0	0	0	0	0	0	0		
Pb-210	0	0	0	0	0	0	0	0		
Pb-211	0	0	0	0	0	0	0	0		
Pb-212	0	0	0	0	0	0	0	0		
Pb-214	0	0	0	0	0	0	0	0		
Po-210	0	0	0	0	0	0	0	0		
Po-212	0	0	0	0	0	0	0	0		
Po-214	0	0	0	0	0	0	0	0		
Po-215	0	0	0	0	0	0	0	0		
Po-216	0	0	0	0	0	0	0	0		
Po-218	0	0	0	0	0	0	0	0		
Rn-219	0	0	0	0	0	0	0	0		
Rn-220	0	0	0	0	0	0	0	0		

Table 4A-6. SDA Trench 6 Radionuclide Inventory (Page 4 of 6)

Nuclide	Curies per Special Purpose Burial Hole													
	SPH-09	SPH-10	SPH-11	SPH-12	SPH-13	SPH-14	SPH-15	SPH-16						
Rn-222	0	0	0	0	0	0	0	0	0	0	0	0	0	0
Ra-223	0	0	0	0	0	0	0	0	0	0	0	0	0	0
Ra-224	0	0	0	0	0	0	0	0	0	0	0	0	0	0
Ra-226	0	0	0	0	0	0	0	0	0	0	0	0	0	0
Ra-228	0	0	0	0	0	0	0	0	0	0	0	0	0	0
Ac-227	0	0	0	0	0	0	0	0	0	0	0	0	0	0
Ac-228	0	0	0	0	0	0	0	0	0	0	0	0	0	0
Th-227	0	0	0	0	0	0	0	0	0	0	0	0	0	0
Th-228	0	0	0	0	0	0	0	0	0	0	0	0	0	0
Th-230	0	0	0	0	0	0	0	0	0	0	0	0	0	0
Th-231	0	0	0	0	0	0	0	0	0	0	0	0	0	0
Th-232	0	0	0	0	0	0	0	0	0	0	0	0	0	0
Th-234	0	0	0	0	0	0	0	0	0	0	0	0	0	0
Pa-231	0	0	0	0	0	0	0	0	0	0	0	0	0	0
Pa-234m	0	0	0	0	0	0	0	0	0	0	0	0	0	0
U-233	0	0	0	0	0	0	0	0	0	0	0	0	0	0
U-234	0	0	0	0	0	0	0	0	0	0	0	0	0	0
U-235	0	0	0	0	0	0	0	0	0	0	0	0	0	0
U-238	0	0	0	0	0	0	0	0	0	0	0	0	0	0
Pu-238	0	0	0	0	0	0	0	0	0	0	0	0	0	0
Pu-239	0	0	0	0	0	0	0	0	0	0	0	0	0	0
Pu-240	0	0	0	0	0	0	0	0	0	0	0	0	0	0
Pu-241	0	0	0	0	0	0	0	0	0	0	0	0	0	0
Am-241	0	0	0	0	0	0	0	0	0	0	0	0	0	0
Cm-242	0	0	0	0	0	0	0	0	0	0	0	0	0	0
Total	2,067.25	1,212.79	1,639.33	3,100.87	2,825.24	0.17	0.07	0.17	0.07	0.07	0.07	0.07	0.07	1,213.60

Table 4A-6. SDA Trench 6 Radionuclide Inventory (Page 5 of 6)

Nuclide	Curies per Special Purpose Burial Hole			Total
	SPH-17	SPH-18	SPH-19	
H-3	1.40E+02	8.53E+01	1.40E+02	2.65E+03
C-14	3.55E-01	2.17E-01	3.55E-01	6.78E+00
Fe-55	8.90E+00	5.44E+00	8.90E+00	1.67E+02
Co-60	2.27E+02	1.39E+02	2.27E+02	4.30E+03
Ni-59	3.20E+01	1.96E+01	3.20E+01	6.11E+02
Ni-63	8.05E+02	4.92E+02	8.05E+02	1.54E+04
Kr-85	0	0	0	0
Sr-90	1.55E-02	9.46E-03	1.55E-02	2.95E-01
Y-90	1.55E-02	9.46E-03	1.55E-02	2.95E-01
Zr-93	0	0	0	0
Nb-94	7.63E-03	4.66E-03	7.63E-03	1.46E-01
Tc-99	1.31E-02	8.00E-03	1.31E-02	2.50E-01
I-129	0	0	0	0
Cs-135	0	0	0	0
Cs-137	5.16E-02	3.15E-02	5.16E-02	9.84E-01
Ba-137m	4.88E-02	2.98E-02	4.88E-02	9.31E-01
Pm-147	0	0	0	0
Tl-207	0	0	0	0
Tl-208	0	0	0	0
Pb-210	0	0	0	0
Pb-211	0	0	0	0
Pb-212	0	0	0	0
Pb-214	0	0	0	0
Bi-210	0	0	0	0
Bi-211	0	0	0	0
Bi-212	0	0	0	0
Bi-214	0	0	0	0
Po-210	0	0	0	0
Po-212	0	0	0	0
Po-214	0	0	0	0
Po-215	0	0	0	0
Po-216	0	0	0	0
Po-218	0	0	0	0
Rn-219	0	0	0	0
Rn-220	0	0	0	0

Table 4A-6. SDA Trench 6 Radionuclide Inventory (Page 6 of 6)

Nuclide	Curies per Special Purpose Burial Hole			Total
	SPH-17	SPH-18	SPH-19	
Rn-222	0	0	0	0
Ra-223	0	0	0	0
Ra-224	0	0	0	0
Ra-226	0	0	0	0
Ra-228	0	0	0	0
Ac-227	0	0	0	0
Ac-228	0	0	0	0
Th-227	0	0	0	0
Th-228	0	0	0	0
Th-230	0	0	0	0
Th-231	0	0	0	0
Th-232	0	0	0	0
Th-234	0	0	0	0
Pa-231	0	0	0	0
Pa-234m	0	0	0	0
U-233	0	0	0	0
U-234	0	0	0	0
U-235	0	0	0	0
U-238	0	0	0	0
Pu-238	0	0	0	0
Pu-239	0	0	0	0
Pu-240	0	0	0	0
Pu-241	0	0	0	0
Am-241	0	0	0	0
Cm-242	0	0	0	0
Total	1,213.60	741.64	1,213.60	23,110.96

Table 4A-7. SDA Trench 7 Radionuclide Inventory (Page 1 of 4)

Nuclide	Curies per Trench Interval (feet from North end)									
	0 - 49	50 - 99	100 - 149	150 - 199	200 - 249	250 - 299	300 - 349	350 - 399		
H-3	3.73E+00	0	0	0	0	0	0	0	0	0
C-14	1.01E+00	0	0	0	0	0	0	0	0	0
Fe-55	6.81E-03	0	0	0	0	0	0	0	0	0
Co-60	8.32E-01	0	0	0	0	0	0	0	0	0
Ni-59	4.21E-02	0	0	0	0	0	0	0	0	0
Ni-63	7.27E+00	0	0	0	0	0	0	0	0	0
Kr-85	0	0	0	0	0	0	0	0	0	0
Sr-90	8.07E-01	0	0	0	0	0	0	0	0	0
Y-90	8.07E-01	0	0	0	0	0	0	0	0	0
Zr-93	0	0	0	0	0	0	0	0	0	0
Nb-94	1.33E-03	0	0	0	0	0	0	0	0	0
Tc-99	8.18E-03	0	0	0	0	0	0	0	0	0
I-129	2.40E-02	0	0	0	0	0	0	0	0	0
Cs-135	8.19E-03	0	0	0	0	0	0	0	0	0
Cs-137	1.01E+02	0	0	0	0	0	0	0	0	0
Ba-137m	9.53E+01	0	0	0	0	0	0	0	0	0
Pm-147	0	0	0	0	0	0	0	0	0	0
Tl-207	1.19E-07	0	0	0	0	0	0	0	0	0
Tl-208	0	0	0	0	0	0	0	0	0	0
Pb-210	3.53E-12	0	0	0	0	0	0	0	0	0
Pb-211	1.19E-07	0	0	0	0	0	0	0	0	0
Pb-212	0	0	0	0	0	0	0	0	0	0
Pb-214	1.63E-11	0	0	0	0	0	0	0	0	0
Bi-210	3.52E-12	0	0	0	0	0	0	0	0	0
Bi-211	1.19E-07	0	0	0	0	0	0	0	0	0
Bi-212	0	0	0	0	0	0	0	0	0	0
Bi-214	1.63E-11	0	0	0	0	0	0	0	0	0
Po-210	3.32E-12	0	0	0	0	0	0	0	0	0
Po-212	0	0	0	0	0	0	0	0	0	0
Po-214	0	0	0	0	0	0	0	0	0	0
Po-215	0	0	0	0	0	0	0	0	0	0
Po-216	0	0	0	0	0	0	0	0	0	0
Po-218	1.63E-11	0	0	0	0	0	0	0	0	0
Rn-219	1.19E-07	0	0	0	0	0	0	0	0	0
Rn-220	0	0	0	0	0	0	0	0	0	0

Table 4A-7. SDA Trench 7 Radionuclide Inventory (Page 2 of 4)

Nuclide	Curies per Trench Interval (feet from North end)									
	0 - 49	50 - 99	100 - 149	150 - 199	200 - 249	250 - 299	300 - 349	350 - 399		
Rn-222	1.63E-11	0	0	0	0	0	0	0	0	0
Ra-223	1.19E-07	0	0	0	0	0	0	0	0	0
Ra-224	0	0	0	0	0	0	0	0	0	0
Ra-226	1.63E-11	0	0	0	0	0	0	0	0	0
Ra-228	0	0	0	0	0	0	0	0	0	0
Ac-227	1.20E-07	0	0	0	0	0	0	0	0	0
Ac-228	0	0	0	0	0	0	0	0	0	0
Th-227	1.18E-07	0	0	0	0	0	0	0	0	0
Th-228	0	0	0	0	0	0	0	0	0	0
Th-230	3.31E-09	0	0	0	0	0	0	0	0	0
Th-231	4.40E-04	0	0	0	0	0	0	0	0	0
Th-232	9.62E-20	0	0	0	0	0	0	0	0	0
Th-234	3.45E-03	0	0	0	0	0	0	0	0	0
Pa-231	3.12E-07	0	0	0	0	0	0	0	0	0
Pa-234m	3.45E-03	0	0	0	0	0	0	0	0	0
U-233	2.22E-10	0	0	0	0	0	0	0	0	0
U-234	2.11E-05	0	0	0	0	0	0	0	0	0
U-235	4.40E-04	0	0	0	0	0	0	0	0	0
U-238	3.45E-03	0	0	0	0	0	0	0	0	0
Pu-238	1.91E-01	0	0	0	0	0	0	0	0	0
Pu-239	1.73E-01	0	0	0	0	0	0	0	0	0
Pu-240	2.65E-04	0	0	0	0	0	0	0	0	0
Pu-241	1.51E+00	0	0	0	0	0	0	0	0	0
Am-241	3.63E-01	0	0	0	0	0	0	0	0	0
Cm-242	0	0	0	0	0	0	0	0	0	0
Total	212.76	0	0	0	0	0	0	0	0	0

Table 4A-7. SDA Trench 7 Radionuclide Inventory (Page 3 of 4)

Nuclide	Curies per Trench Interval (feet from North end)							Total
	400 - 449	450 - 499	500 - 549	550 - 599	600 - 649	650 - 699	700 - 750	
H-3	0	0	0	0	0	0	0	3.73E+00
C-14	0	0	0	0	0	0	0	1.01E+00
Fe-55	0	0	0	0	0	0	0	6.81E-03
Co-60	0	0	0	0	0	0	0	8.32E-01
Ni-59	0	0	0	0	0	0	0	4.21E-02
Ni-63	0	0	0	0	0	0	0	7.27E+00
Kr-85	0	0	0	0	0	0	0	0
Sr-90	0	0	0	0	0	0	0	8.07E-01
Y-90	0	0	0	0	0	0	0	8.07E-01
Zr-93	0	0	0	0	0	0	0	0
Nb-94	0	0	0	0	0	0	0	1.33E-03
Tc-99	0	0	0	0	0	0	0	8.18E-03
I-129	0	0	0	0	0	0	0	2.40E-02
Cs-135	0	0	0	0	0	0	0	8.19E-03
Cs-137	0	0	0	0	0	0	0	1.01E+02
Ba-137m	0	0	0	0	0	0	0	9.53E+01
Pm-147	0	0	0	0	0	0	0	0
Tl-207	0	0	0	0	0	0	0	1.19E-07
Tl-208	0	0	0	0	0	0	0	0
Pb-210	0	0	0	0	0	0	0	3.53E-12
Pb-211	0	0	0	0	0	0	0	1.19E-07
Pb-212	0	0	0	0	0	0	0	0
Pb-214	0	0	0	0	0	0	0	1.63E-11
Bi-210	0	0	0	0	0	0	0	3.52E-12
Bi-211	0	0	0	0	0	0	0	1.19E-07
Bi-212	0	0	0	0	0	0	0	0
Bi-214	0	0	0	0	0	0	0	1.63E-11
Po-210	0	0	0	0	0	0	0	3.32E-12
Po-212	0	0	0	0	0	0	0	0
Po-214	0	0	0	0	0	0	0	0
Po-215	0	0	0	0	0	0	0	0
Po-216	0	0	0	0	0	0	0	0
Po-218	0	0	0	0	0	0	0	1.63E-11
Rn-219	0	0	0	0	0	0	0	1.19E-07
Rn-220	0	0	0	0	0	0	0	0

Table 4A-7. SDA Trench 7 Radionuclide Inventory (Page 4 of 4)

Nuclide	Curies per Trench Interval (feet from North end)										Total
	400 - 449	450 - 499	500 - 549	550 - 599	600 - 649	650 - 699	700 - 750				
Rn-222	0	0	0	0	0	0	0	0	0	0	1.63E-11
Ra-223	0	0	0	0	0	0	0	0	0	0	1.19E-07
Ra-224	0	0	0	0	0	0	0	0	0	0	0
Ra-226	0	0	0	0	0	0	0	0	0	0	1.63E-11
Ra-228	0	0	0	0	0	0	0	0	0	0	0
Ac-227	0	0	0	0	0	0	0	0	0	0	1.20E-07
Ac-228	0	0	0	0	0	0	0	0	0	0	0
Th-227	0	0	0	0	0	0	0	0	0	0	1.18E-07
Th-228	0	0	0	0	0	0	0	0	0	0	0
Th-230	0	0	0	0	0	0	0	0	0	0	3.31E-09
Th-231	0	0	0	0	0	0	0	0	0	0	4.40E-04
Th-232	0	0	0	0	0	0	0	0	0	0	9.62E-20
Th-234	0	0	0	0	0	0	0	0	0	0	3.45E-03
Pa-231	0	0	0	0	0	0	0	0	0	0	3.12E-07
Pa-234m	0	0	0	0	0	0	0	0	0	0	3.45E-03
U-233	0	0	0	0	0	0	0	0	0	0	2.22E-10
U-234	0	0	0	0	0	0	0	0	0	0	2.11E-05
U-235	0	0	0	0	0	0	0	0	0	0	4.40E-04
U-238	0	0	0	0	0	0	0	0	0	0	3.45E-03
Pu-238	0	0	0	0	0	0	0	0	0	0	1.91E-01
Pu-239	0	0	0	0	0	0	0	0	0	0	1.73E-01
Pu-240	0	0	0	0	0	0	0	0	0	0	2.65E-04
Pu-241	0	0	0	0	0	0	0	0	0	0	1.51E+00
Am-241	0	0	0	0	0	0	0	0	0	0	3.63E-01
Cm-242	0	0	0	0	0	0	0	0	0	0	0
Total	0	0	0	0	0	0	0	0	0	0	212.76

Table 4A-8. SDA Trench 8 Radionuclide Inventory (Page 1 of 4)

Nuclide	Curies per Trench Interval (feet from North end)									
	0 - 49	50 - 99	100 - 149	150 - 199	200 - 249	250 - 299	300 - 349	350 - 399		
H-3	1.18E+03	1.01E+03	1.41E+01	2.20E+03	2.36E+02	6.38E+01	1.21E+01	1.61E+03		
C-14	1.89E+00	9.52E-01	2.21E+00	2.39E+00	4.28E+00	3.57E+00	1.53E-01	1.54E+00		
Fe-55	7.48E-03	9.07E-03	3.88E-03	1.76E-03	6.41E-04	3.80E-03	2.46E-01	9.50E-03		
Co-60	5.94E-01	7.90E-01	3.95E-01	1.57E-01	5.98E-02	4.29E-01	1.00E+01	6.76E-01		
Ni-59	1.87E-02	2.67E-02	1.10E-02	5.17E-03	1.83E-03	9.93E-03	1.75E+00	1.99E-02		
Ni-63	2.87E+00	5.98E+00	1.78E+00	1.16E+00	3.36E-01	1.80E+00	4.29E+01	1.89E+00		
Kr-85	0	0	0	0	0	0	0	0		
Sr-90	3.99E-01	7.24E-01	1.01E+00	7.43E-02	1.00E-01	1.71E+00	1.73E-01	1.06E-01		
Y-90	3.99E-01	7.24E-01	1.01E+00	7.44E-02	1.00E-01	1.71E+00	1.74E-01	1.06E-01		
Zr-93	1.18E-07	1.09E-07	3.41E-07	3.27E-07	4.51E-07	1.75E-07	4.45E-06	1.92E-07		
Nb-94	5.91E-04	8.47E-04	3.47E-04	1.64E-04	5.80E-05	3.14E-04	2.18E-03	6.30E-04		
Tc-99	3.33E-03	6.14E-03	1.97E-03	3.07E-04	3.79E-04	5.67E-04	3.18E-03	9.98E-04		
I-129	9.75E-03	1.81E-02	5.77E-03	8.80E-04	1.11E-03	1.61E-03	6.54E-03	2.75E-03		
Cs-135	3.34E-03	6.14E-03	1.97E-03	3.01E-04	3.77E-04	5.59E-04	2.51E-03	1.00E-03		
Cs-137	4.42E+01	8.11E+01	2.70E+01	4.03E+00	5.05E+00	9.05E+00	3.33E+01	1.34E+01		
Ba-137m	4.18E+01	7.67E+01	2.55E+01	3.81E+00	4.78E+00	8.56E+00	3.15E+01	1.27E+01		
Pm-147	2.92E-06	7.23E-05	8.41E-06	8.05E-06	1.11E-05	5.43E-06	1.43E-04	6.17E-06		
Ti-207	3.55E-06	2.16E-06	4.16E-05	4.54E-05	1.24E-05	4.42E-06	1.21E-05	1.02E-05		
Ti-208	1.38E-01	8.83E-04	5.94E-07	2.55E-03	7.86E-07	1.25E-01	3.90E-03	6.99E-01		
Pb-210	6.63E-04	6.19E-03	5.48E-02	1.69E-01	5.68E-01	2.27E-04	8.96E-03	5.76E-04		
Pb-211	3.56E-06	2.17E-06	4.17E-05	4.55E-05	1.24E-05	4.43E-06	1.22E-05	1.02E-05		
Pb-212	3.85E-01	2.46E-03	1.65E-06	7.09E-03	2.19E-06	3.48E-01	1.08E-02	1.95E+00		
Pb-214	1.08E-03	1.00E-02	8.90E-02	2.74E-01	9.26E-01	3.76E-04	1.48E-02	9.55E-04		
Bi-210	6.63E-04	6.18E-03	5.48E-02	1.69E-01	5.67E-01	2.27E-04	8.95E-03	5.76E-04		
Bi-211	3.56E-06	2.17E-06	4.17E-05	4.55E-05	1.24E-05	4.43E-06	1.22E-05	1.02E-05		
Bi-212	3.85E-01	2.46E-03	1.65E-06	7.09E-03	2.19E-06	3.48E-01	1.08E-02	1.95E+00		
Bi-214	1.08E-03	1.00E-02	8.90E-02	2.74E-01	9.26E-01	3.76E-04	1.48E-02	9.55E-04		
Po-210	6.56E-04	6.12E-03	5.42E-02	1.67E-01	5.61E-01	2.24E-04	8.85E-03	5.69E-04		
Po-212	2.47E-01	0	0	0	0	2.23E-01	6.95E-03	1.25E+00		
Po-214	1.08E-03	1.00E-02	8.90E-02	2.74E-01	9.26E-01	3.76E-04	1.48E-02	9.55E-04		
Po-215	3.56E-06	2.17E-06	4.17E-05	4.55E-05	1.24E-05	4.43E-06	1.22E-05	1.02E-05		
Po-216	3.85E-01	2.46E-03	1.65E-06	7.09E-03	2.19E-06	3.48E-01	1.08E-02	1.95E+00		
Po-218	1.08E-03	1.00E-02	8.90E-02	2.74E-01	9.27E-01	3.76E-04	1.48E-02	9.55E-04		
Rn-219	3.56E-06	2.17E-06	4.17E-05	4.55E-05	1.24E-05	4.43E-06	1.22E-05	1.02E-05		
Rn-220	3.85E-01	2.46E-03	1.65E-06	7.09E-03	2.19E-06	3.48E-01	1.08E-02	1.95E+00		

Table 4A-8. SDA Trench 8 Radionuclide Inventory (Page 2 of 4)

Nuclide	Curies per Trench Interval (feet from North end)									
	0 - 49	50 - 99	100 - 149	150 - 199	200 - 249	250 - 299	300 - 349	350 - 399		
Rn-222	1.08E-03	1.00E-02	8.90E-02	2.74E-01	9.27E-01	3.76E-04	1.48E-02	9.55E-04		
Ra-223	3.56E-06	2.17E-06	4.17E-05	4.55E-05	1.24E-05	4.43E-06	1.22E-05	1.02E-05		
Ra-224	3.85E-01	2.46E-03	1.65E-06	7.09E-03	2.19E-06	3.48E-01	1.08E-02	1.95E+00		
Ra-226	1.08E-03	1.00E-02	8.90E-02	2.74E-01	9.27E-01	3.76E-04	1.48E-02	9.55E-04		
Ra-228	3.90E-01	2.49E-03	2.19E-09	7.18E-03	2.90E-09	3.53E-01	1.10E-02	1.98E+00		
Ac-227	3.58E-06	2.18E-06	4.20E-05	4.58E-05	1.25E-05	4.46E-06	1.23E-05	1.03E-05		
Ac-228	3.90E-01	2.49E-03	2.19E-09	7.18E-03	2.90E-09	3.53E-01	1.10E-02	1.98E+00		
Th-227	3.52E-06	2.14E-06	4.12E-05	4.50E-05	1.23E-05	4.38E-06	1.20E-05	1.01E-05		
Th-228	3.85E-01	2.46E-03	1.65E-06	7.09E-03	2.19E-06	3.48E-01	1.08E-02	1.95E+00		
Th-230	1.05E-04	4.18E-05	1.51E-03	1.65E-03	4.29E-04	1.77E-04	4.34E-04	3.67E-04		
Th-231	1.55E-02	9.37E-03	1.81E-01	1.97E-01	5.36E-02	2.03E-02	5.51E-02	4.69E-02		
Th-232	4.01E-01	2.55E-03	2.23E-09	7.36E-03	2.95E-09	3.63E-01	1.13E-02	2.03E+00		
Th-234	4.50E-01	1.54E-01	1.26E+01	1.39E+01	3.50E+00	1.34E+00	3.63E+00	3.05E+00		
Pa-231	9.97E-06	6.05E-06	1.16E-04	1.27E-04	3.46E-05	1.27E-05	3.46E-05	2.93E-05		
Pa-234m	4.50E-01	1.54E-01	1.26E+01	1.39E+01	3.50E+00	1.34E+00	3.63E+00	3.05E+00		
U-233	1.21E-06	1.12E-06	3.48E-06	3.33E-06	4.60E-06	1.79E-06	4.54E-05	1.96E-06		
U-234	4.89E-01	1.53E-01	5.49E+00	6.02E+00	1.56E+00	7.41E-01	1.64E+00	1.39E+00		
U-235	1.55E-02	9.37E-03	1.81E-01	1.97E-01	5.36E-02	2.03E-02	5.51E-02	4.69E-02		
U-238	4.50E-01	1.54E-01	1.26E+01	1.39E+01	3.50E+00	1.34E+00	3.63E+00	3.05E+00		
Pu-238	2.27E+03	4.89E+00	4.65E-02	1.52E+00	3.07E+00	1.60E+03	5.53E+01	1.98E+02		
Pu-239	1.84E+00	4.03E+00	4.10E-02	1.25E+00	2.53E+00	1.43E+00	1.78E-02	1.54E-02		
Pu-240	4.25E-01	4.12E+00	1.71E-04	1.31E+00	2.66E+00	1.50E+00	1.49E-03	2.84E-03		
Pu-241	1.38E+01	1.29E+02	4.18E-01	4.06E+01	8.24E+01	4.88E+01	2.44E-01	2.55E-01		
Am-241	1.56E+00	1.40E+01	8.60E-02	4.39E+00	8.90E+00	6.42E+00	4.09E-02	3.98E-02		
Cm-242	1.52E-07	1.40E-07	4.38E-07	4.19E-07	5.79E-07	2.26E-07	5.74E-06	2.48E-07		
Total	3,562.63	1,337.07	118.13	2,309.68	369.44	1,757.20	200.84	1,868.41		

Table 4A-8. SDA Trench 8 Radionuclide Inventory (Page 3 of 4)

Nuclide	Curies per Trench Interval (feet from North end)										Total
	400 - 449	450 - 499	500 - 549	550 - 599	600 - 649	650 - 699	700 - 750				
H-3	1.71E+02	4.36E+02	3.27E+00	0	0	0	0	0	0	0	6.93E+03
C-14	9.64E-01	2.12E+00	7.29E-01	0	0	0	0	0	0	0	2.08E+01
Fe-55	5.13E-01	1.19E-03	8.10E-03	0	0	0	0	0	0	0	8.05E-01
Co-60	2.02E+01	9.51E-02	6.29E-01	0	0	0	0	0	0	0	3.40E+01
Ni-59	3.77E+00	2.75E-03	1.87E-02	0	0	0	0	0	0	0	5.64E+00
Ni-63	9.25E+01	6.89E-01	4.58E+00	0	0	0	0	0	0	0	1.57E+02
Kr-85	0	0	0	0	0	0	0	0	0	0	0
Sr-90	1.21E-01	6.01E-02	6.04E-01	0	0	0	0	0	0	0	5.09E+00
Y-90	1.21E-01	6.02E-02	6.04E-01	0	0	0	0	0	0	0	5.09E+00
Zr-93	1.49E-07	1.70E-07	7.45E-08	0	0	0	0	0	0	0	6.56E-06
Nb-94	3.20E-03	8.70E-05	5.93E-04	0	0	0	0	0	0	0	9.02E-03
Tc-99	4.72E-03	3.06E-04	5.00E-03	0	0	0	0	0	0	0	2.69E-02
I-129	8.53E-03	8.94E-04	1.48E-02	0	0	0	0	0	0	0	7.07E-02
Cs-135	3.28E-03	3.03E-04	5.00E-03	0	0	0	0	0	0	0	2.48E-02
Cs-137	4.33E+01	4.12E+00	6.75E+01	0	0	0	0	0	0	0	3.32E+02
Ba-137m	4.10E+01	3.90E+00	6.38E+01	0	0	0	0	0	0	0	3.14E+02
Pm-147	4.77E-06	5.46E-06	2.39E-06	0	0	0	0	0	0	0	2.70E-04
Ti-207	3.17E-06	1.12E-06	3.74E-06	0	0	0	0	0	0	0	1.40E-04
Ti-208	2.62E-07	1.94E-01	8.46E-05	0	0	0	0	0	0	0	1.16E+00
Pb-210	7.48E-04	3.42E-08	1.34E-03	0	0	0	0	0	0	0	8.10E-01
Pb-211	3.18E-06	1.13E-06	3.75E-06	0	0	0	0	0	0	0	1.40E-04
Pb-212	7.28E-07	5.40E-01	2.35E-04	0	0	0	0	0	0	0	3.24E+00
Pb-214	1.24E-03	1.38E-07	2.23E-03	0	0	0	0	0	0	0	1.32E+00
Bi-210	7.48E-04	3.41E-08	1.34E-03	0	0	0	0	0	0	0	8.10E-01
Bi-211	3.18E-06	1.13E-06	3.75E-06	0	0	0	0	0	0	0	1.40E-04
Bi-212	7.28E-07	5.40E-01	2.35E-04	0	0	0	0	0	0	0	3.24E+00
Bi-214	1.24E-03	1.38E-07	2.23E-03	0	0	0	0	0	0	0	1.32E+00
Po-210	7.39E-04	3.24E-08	1.33E-03	0	0	0	0	0	0	0	8.01E-01
Po-212	0	3.46E-01	0	0	0	0	0	0	0	0	2.07E+00
Po-214	1.24E-03	0	2.23E-03	0	0	0	0	0	0	0	1.32E+00
Po-215	3.18E-06	1.13E-06	3.75E-06	0	0	0	0	0	0	0	1.40E-04
Po-216	7.28E-07	5.40E-01	2.35E-04	0	0	0	0	0	0	0	3.24E+00
Po-218	1.24E-03	1.38E-07	2.23E-03	0	0	0	0	0	0	0	1.32E+00
Rn-219	3.18E-06	1.13E-06	3.75E-06	0	0	0	0	0	0	0	1.40E-04
Rn-220	7.28E-07	5.40E-01	2.35E-04	0	0	0	0	0	0	0	3.24E+00

Table 4A-8. SDA Trench 8 Radionuclide Inventory (Page 4 of 4)

Nuclide	Curies per Trench Interval (feet from North end)										Total	
	400 - 449	450 - 499	500 - 549	550 - 599	600 - 649	650 - 699	700 - 750					
Rn-222	1.24E-03	1.38E-07	2.23E-03	0	0	0	0	0	0	0	0	1.32E+00
Ra-223	3.18E-06	1.13E-06	3.75E-06	0	0	0	0	0	0	0	0	1.40E-04
Ra-224	7.28E-07	5.40E-01	2.35E-04	0	0	0	0	0	0	0	0	3.24E+00
Ra-226	1.24E-03	1.38E-07	2.23E-03	0	0	0	0	0	0	0	0	1.32E+00
Ra-228	9.54E-10	5.49E-01	2.38E-04	0	0	0	0	0	0	0	0	3.29E+00
Ac-227	3.20E-06	1.13E-06	3.78E-06	0	0	0	0	0	0	0	0	1.41E-04
Ac-228	9.54E-10	5.49E-01	2.38E-04	0	0	0	0	0	0	0	0	3.29E+00
Th-227	3.14E-06	1.11E-06	3.71E-06	0	0	0	0	0	0	0	0	1.39E-04
Th-228	7.28E-07	5.40E-01	2.35E-04	0	0	0	0	0	0	0	0	3.24E+00
Th-230	1.08E-04	2.18E-05	1.18E-04	0	0	0	0	0	0	0	0	4.96E-03
Th-231	1.46E-02	5.15E-03	1.72E-02	0	0	0	0	0	0	0	0	6.15E-01
Th-232	9.72E-10	5.65E-01	2.45E-04	0	0	0	0	0	0	0	0	3.38E+00
Th-234	8.37E-01	8.36E-02	8.61E-01	0	0	0	0	0	0	0	0	4.04E+01
Pa-231	9.09E-06	3.22E-06	1.07E-05	0	0	0	0	0	0	0	0	3.94E-04
Pa-234m	8.37E-01	8.36E-02	8.61E-01	0	0	0	0	0	0	0	0	4.04E+01
U-233	1.52E-06	1.73E-06	7.59E-07	0	0	0	0	0	0	0	0	6.69E-05
U-234	4.09E-01	8.20E-02	4.47E-01	0	0	0	0	0	0	0	0	1.84E+01
U-235	1.46E-02	5.15E-03	1.72E-02	0	0	0	0	0	0	0	0	6.15E-01
U-238	8.37E-01	8.36E-02	8.61E-01	0	0	0	0	0	0	0	0	4.04E+01
Pu-238	9.58E+00	8.27E-03	1.22E+01	0	0	0	0	0	0	0	0	4.16E+03
Pu-239	9.46E+00	6.80E-03	1.11E-01	0	0	0	0	0	0	0	0	2.07E+01
Pu-240	8.23E+00	6.52E-05	1.80E-04	0	0	0	0	0	0	0	0	1.82E+01
Pu-241	2.67E+02	8.11E-02	1.17E+00	0	0	0	0	0	0	0	0	5.84E+02
Am-241	2.72E+01	1.53E-02	2.27E-01	0	0	0	0	0	0	0	0	6.29E+01
Cm-242	1.92E-07	2.19E-07	9.60E-08	0	0	0	0	0	0	0	0	8.45E-06
Total	698.49	452.84	158.57	0	0	0	0	0	0	0	0	12,833.31

Table 4A-9. SDA Trench 9 Radionuclide Inventory (Page 1 of 4)

Nuclide	Curies per Trench Interval (feet from North end)									
	0 - 49	50 - 99	100 - 149	150 - 199	200 - 249	250 - 299	300 - 349	350 - 399		
H-3	2.08E+01	1.01E+01	1.68E+03	5.80E+01	3.82E+01	3.52E+01	1.44E+01	1.58E+03		
C-14	1.03E-01	2.21E+00	7.25E+00	2.65E+00	1.89E+00	3.63E+00	2.83E+00	9.28E+00		
Fe-55	4.22E-02	2.57E-02	6.57E-03	4.24E-02	2.82E-02	4.83E-02	5.99E-02	4.19E-02		
Co-60	2.85E+00	1.99E+00	3.20E+00	2.87E+00	1.93E+00	3.34E+00	4.10E+00	2.95E+00		
Ni-59	8.48E-02	5.95E-02	1.07E-02	7.52E-02	5.04E-02	8.66E-02	1.07E-01	7.40E-02		
Ni-63	1.69E+00	1.48E+01	1.02E+00	1.77E+01	1.23E+01	2.18E+01	2.67E+01	1.70E+01		
Kr-85	0	3.72E-01	0	0	0	0	0	0		
Sr-90	1.09E-01	1.89E+00	1.90E-01	2.29E+00	1.61E+00	2.80E+00	2.51E+00	2.15E+00		
Y-90	1.09E-01	1.89E+00	1.90E-01	2.29E+00	1.61E+00	2.80E+00	2.51E+00	2.15E+00		
Zr-93	8.34E-08	3.66E-07	9.55E-08	2.00E-07	6.23E-08	1.42E-07	8.89E-09	5.92E-08		
Nb-94	2.68E-03	1.89E-03	3.39E-04	2.38E-03	1.60E-03	2.74E-03	3.40E-03	2.35E-03		
Tc-99	3.73E-03	1.61E-02	1.26E-03	1.94E-02	1.34E-02	2.27E-02	2.13E-02	1.81E-02		
I-129	9.96E-03	4.78E-02	3.63E-03	5.72E-02	3.95E-02	6.72E-02	6.29E-02	5.35E-02		
Cs-135	3.82E-03	1.61E-02	1.27E-03	1.94E-02	1.34E-02	2.27E-02	2.13E-02	1.81E-02		
Cs-137	5.05E+01	2.18E+02	1.75E+01	2.68E+02	1.85E+02	3.17E+02	2.94E+02	2.50E+02		
Ba-137m	4.77E+01	2.06E+02	1.65E+01	2.53E+02	1.75E+02	3.00E+02	2.78E+02	2.37E+02		
Pm-147	2.68E-06	7.56E-04	3.99E-06	8.36E-06	2.61E-06	5.95E-06	3.72E-07	2.48E-06		
Ti-207	3.78E-07	3.60E-06	1.71E-06	1.28E-06	5.81E-06	2.01E-05	3.07E-07	3.11E-07		
Ti-208	1.92E-05	5.07E-04	1.70E-07	3.55E-07	1.11E-07	1.70E-05	4.69E-03	7.64E-03		
Pb-210	4.54E-04	2.98E-03	7.65E-03	3.24E-08	2.74E-04	1.47E-03	2.11E-08	6.38E-03		
Pb-211	3.79E-07	3.61E-06	1.72E-06	1.28E-06	5.82E-06	2.01E-05	3.07E-07	3.12E-07		
Pb-212	5.34E-05	1.41E-03	4.72E-07	9.89E-07	3.08E-07	4.74E-05	1.31E-02	2.13E-02		
Pb-214	7.53E-04	4.94E-03	1.29E-02	1.35E-07	4.64E-04	2.48E-03	1.11E-07	1.08E-02		
Bi-210	4.54E-04	2.98E-03	7.64E-03	3.23E-08	2.74E-04	1.47E-03	2.11E-08	6.38E-03		
Bi-211	3.79E-07	3.61E-06	1.72E-06	1.28E-06	5.82E-06	2.01E-05	3.07E-07	3.12E-07		
Bi-212	5.34E-05	1.41E-03	4.72E-07	9.89E-07	3.08E-07	4.74E-05	1.31E-02	2.13E-02		
Bi-214	7.53E-04	4.94E-03	1.29E-02	1.35E-07	4.64E-04	2.48E-03	1.11E-07	1.08E-02		
Po-210	4.49E-04	2.95E-03	7.55E-03	3.06E-08	2.71E-04	1.45E-03	1.96E-08	6.30E-03		
Po-212	0	0	0	0	0	0	8.36E-03	1.36E-02		
Po-214	7.52E-04	4.94E-03	1.29E-02	0	4.64E-04	2.48E-03	0	1.08E-02		
Po-215	0	3.61E-06	1.72E-06	1.28E-06	5.82E-06	2.01E-05	0	0		
Po-216	5.34E-05	1.41E-03	4.72E-07	9.89E-07	3.08E-07	4.74E-05	1.31E-02	2.13E-02		
Po-218	7.53E-04	4.94E-03	1.29E-02	1.35E-07	4.65E-04	2.48E-03	1.12E-07	1.08E-02		
Rn-219	3.79E-07	3.61E-06	1.72E-06	1.28E-06	5.82E-06	2.01E-05	3.07E-07	3.12E-07		
Rn-220	5.34E-05	1.41E-03	4.72E-07	9.89E-07	3.08E-07	4.74E-05	1.31E-02	2.13E-02		

Table 4A-9. SDA Trench 9 Radionuclide Inventory (Page 2 of 4)

Nuclide	Curies per Trench Interval (feet from North end)									
	0 - 49	50 - 99	100 - 149	150 - 199	200 - 249	250 - 299	300 - 349	350 - 399		
Rn-222	7.53E-04	4.94E-03	1.29E-02	1.35E-07	4.65E-04	2.48E-03	1.12E-07	1.08E-02		
Ra-223	3.79E-07	3.61E-06	1.72E-06	1.28E-06	5.82E-06	2.01E-05	3.07E-07	3.12E-07		
Ra-224	5.34E-05	1.41E-03	4.72E-07	9.89E-07	3.08E-07	4.74E-05	1.31E-02	2.13E-02		
Ra-226	7.53E-04	4.94E-03	1.29E-02	1.36E-07	4.65E-04	2.48E-03	1.12E-07	1.08E-02		
Ra-228	5.35E-05	1.43E-03	6.11E-10	1.28E-09	3.99E-10	4.75E-05	1.33E-02	2.16E-02		
Ac-227	3.81E-07	3.64E-06	1.73E-06	1.29E-06	5.87E-06	2.03E-05	3.10E-07	3.14E-07		
Ac-228	5.35E-05	1.43E-03	6.11E-10	1.28E-09	3.99E-10	4.75E-05	1.33E-02	2.16E-02		
Th-227	3.74E-07	3.57E-06	1.70E-06	1.27E-06	5.76E-06	1.99E-05	3.04E-07	3.08E-07		
Th-228	5.34E-05	1.41E-03	4.72E-07	9.89E-07	3.08E-07	4.74E-05	1.31E-02	2.13E-02		
Th-230	6.14E-06	1.37E-04	6.78E-05	2.23E-05	2.12E-04	7.57E-04	2.67E-05	5.57E-09		
Th-231	1.72E-03	1.65E-02	8.35E-03	6.22E-03	2.84E-02	9.81E-02	1.50E-03	1.51E-03		
Th-232	5.47E-05	1.47E-03	6.24E-10	1.31E-09	4.07E-10	4.91E-05	1.37E-02	2.23E-02		
Th-234	2.04E-03	8.96E-01	5.84E-01	9.53E-02	1.89E+00	6.81E+00	9.62E-03	8.04E-03		
Pa-231	1.08E-06	1.03E-05	5.04E-06	3.76E-06	1.71E-05	5.91E-05	9.03E-07	9.14E-07		
Pa-234m	2.04E-03	8.96E-01	5.84E-01	9.53E-02	1.89E+00	6.81E+00	9.62E-03	8.04E-03		
U-233	2.46E+00	3.73E-06	9.73E-07	2.08E-06	6.35E-07	1.45E-06	9.10E-08	6.04E-07		
U-234	2.31E-02	5.89E-01	2.75E-01	9.00E-02	8.36E-01	2.95E+00	2.01E-01	4.18E-05		
U-235	1.72E-03	1.65E-02	8.35E-03	6.22E-03	2.84E-02	9.81E-02	1.50E-03	1.51E-03		
U-238	2.04E-03	8.96E-01	5.84E-01	9.53E-02	1.89E+00	6.81E+00	9.62E-03	8.04E-03		
Pu-238	3.88E-02	1.62E+03	2.38E+02	6.89E+01	1.96E+02	5.75E-01	2.22E+03	4.54E-01		
Pu-239	2.47E-02	1.89E+00	2.30E-02	5.07E+01	2.96E-01	5.04E-01	4.72E-01	5.22E-01		
Pu-240	9.76E-05	1.61E+00	6.58E-05	5.31E+01	4.29E-04	7.43E-04	6.62E-04	5.71E-04		
Pu-241	2.91E-01	5.61E+01	2.58E-01	1.81E+03	3.27E+00	5.59E+00	5.36E+00	4.41E+00		
Am-241	5.34E-02	1.04E+01	4.73E-02	1.73E+02	6.02E-01	1.03E+00	9.81E-01	8.10E-01		
Cm-242	1.07E-07	4.73E-07	1.24E-07	2.59E-07	8.07E-08	1.85E-07	1.15E-08	7.67E-08		
Total	126.92	2,151.32	1,968.19	2,767.06	623.85	717.55	2,848.73	2,110.96		

Table 4A-9. SDA Trench 9 Radionuclide Inventory (Page 3 of 4)

Nuclide	Curies per Trench Interval (feet from North end)										Total	
	400 - 449	450 - 499	500 - 549	550 - 599	600 - 649	650 - 699	700 - 750					
H-3	1.25E+02	2.62E+02	5.64E+01	3.16E-02	0	0	0	0	0	0	0	3.89E+03
C-14	3.29E-01	3.61E+00	1.05E-01	8.43E-03	0	0	0	0	0	0	0	3.39E+01
Fe-55	1.54E-02	4.83E-02	3.48E-03	2.42E-05	0	0	0	0	0	0	0	3.62E-01
Co-60	9.39E-01	3.22E+00	2.15E-01	2.02E-03	0	0	0	0	0	0	0	2.76E+01
Ni-59	2.42E-02	8.43E-02	5.54E-03	4.31E-05	0	0	0	0	0	0	0	6.62E-01
Ni-63	7.78E-01	1.78E+01	3.62E-01	1.09E-02	0	0	0	0	0	0	0	1.32E+02
Kr-85	0	0	0	0	0	0	0	0	0	0	0	3.72E-01
Sr-90	1.20E-01	2.26E+00	5.20E-02	3.03E-03	0	0	0	0	0	0	0	1.60E+01
Y-90	1.20E-01	2.26E+00	5.20E-02	3.04E-03	0	0	0	0	0	0	0	1.60E+01
Zr-93	0	5.67E-08	0	1.85E-08	0	0	0	0	0	0	0	1.09E-06
Nb-94	7.63E-04	2.67E-03	1.75E-04	1.36E-06	0	0	0	0	0	0	0	2.10E-02
Tc-99	1.27E-03	1.97E-02	4.17E-04	1.19E-05	0	0	0	0	0	0	0	1.37E-01
I-129	3.45E-03	5.80E-02	1.18E-03	3.49E-05	0	0	0	0	0	0	0	4.04E-01
Cs-135	1.29E-03	8.36E-01	5.20E+00	1.18E-05	0	0	0	0	0	0	0	6.15E+00
Cs-137	1.86E+01	2.72E+02	5.79E+00	1.67E-01	0	0	0	0	0	0	0	1.90E+03
Ba-137m	1.76E+01	2.57E+02	5.48E+00	1.58E-01	0	0	0	0	0	0	0	1.79E+03
Pm-147	0	2.37E-06	0	7.74E-07	0	0	0	0	0	0	0	7.86E-04
Ti-207	1.46E-06	2.26E-07	6.46E-08	9.80E-08	0	0	0	0	0	0	0	3.53E-05
Tl-208	0	9.78E-03	0	3.29E-08	0	0	0	0	0	0	0	2.27E-02
Pb-210	2.79E-02	9.92E-05	3.39E-01	2.92E-02	0	0	0	0	0	0	0	4.15E-01
Pb-211	1.46E-06	2.27E-07	6.48E-08	9.83E-08	0	0	0	0	0	0	0	3.54E-05
Pb-212	0	2.72E-02	0	9.15E-08	0	0	0	0	0	0	0	6.30E-02
Pb-214	4.71E-02	1.68E-04	5.73E-01	4.94E-02	0	0	0	0	0	0	0	7.02E-01
Po-210	2.75E-02	9.80E-05	3.35E-01	2.89E-02	0	0	0	0	0	0	0	4.10E-01
Po-212	0	1.74E-02	0	0	0	0	0	0	0	0	0	3.94E-02
Po-214	4.71E-02	1.68E-04	5.73E-01	4.94E-02	0	0	0	0	0	0	0	7.02E-01
Po-215	1.46E-06	0	0	0	0	0	0	0	0	0	0	3.40E-05
Po-216	0	2.72E-02	0	9.15E-08	0	0	0	0	0	0	0	6.30E-02
Po-218	4.71E-02	1.68E-04	5.73E-01	4.94E-02	0	0	0	0	0	0	0	7.02E-01
Rn-219	1.46E-06	2.27E-07	6.48E-08	9.83E-08	0	0	0	0	0	0	0	3.54E-05
Rn-220	0	2.72E-02	0	9.15E-08	0	0	0	0	0	0	0	6.30E-02

Table 4A-9. SDA Trench 9 Radionuclide Inventory (Page 4 of 4)

Nuclide	Curies per Trench Interval (feet from North end)										Total
	400 - 449	450 - 499	500 - 549	550 - 599	600 - 649	650 - 699	700 - 750				
Rn-222	4.71E-02	1.68E-04	5.73E-01	4.94E-02	0	0	0	0	0	0	7.02E-01
Ra-223	1.46E-06	2.27E-07	6.48E-08	9.83E-08	0	0	0	0	0	0	3.54E-05
Ra-224	0	2.72E-02	0	9.15E-08	0	0	0	0	0	0	6.30E-02
Ra-226	4.71E-02	1.68E-04	5.73E-01	4.94E-02	0	0	0	0	0	0	7.02E-01
Ra-228	0	2.77E-02	0	1.18E-10	0	0	0	0	0	0	6.41E-02
Ac-227	1.47E-06	2.29E-07	6.53E-08	9.90E-08	0	0	0	0	0	0	3.57E-05
Ac-228	0	2.77E-02	0	1.18E-10	0	0	0	0	0	0	6.41E-02
Th-227	1.44E-06	2.24E-07	6.41E-08	9.72E-08	0	0	0	0	0	0	3.50E-05
Th-228	0	2.72E-02	0	9.15E-08	0	0	0	0	0	0	6.31E-02
Th-230	5.04E-05	5.98E-09	9.43E-11	9.11E-12	0	0	0	0	0	0	1.28E-03
Th-231	7.12E-03	1.10E-03	3.16E-04	4.76E-04	0	0	0	0	0	0	1.71E-01
Th-232	6.74E-21	2.86E-02	2.65E-21	1.21E-10	0	0	0	0	0	0	6.62E-02
Th-234	4.52E-01	8.60E-03	1.10E-04	5.34E-06	0	0	0	0	0	0	1.08E+01
Pa-231	4.29E-06	6.64E-07	1.90E-07	2.88E-07	0	0	0	0	0	0	1.04E-04
Pa-234m	4.52E-01	8.60E-03	1.10E-04	5.34E-06	0	0	0	0	0	0	1.08E+01
U-233	1.13E-11	5.78E-07	5.71E-12	1.89E-07	0	0	0	0	0	0	2.46E+00
U-234	1.96E-01	4.49E-05	7.09E-07	3.71E-08	0	0	0	0	0	0	5.16E+00
U-235	7.12E-03	1.10E-03	3.16E-04	4.76E-04	0	0	0	0	0	0	1.71E-01
U-238	4.52E-01	8.60E-03	1.10E-04	5.34E-06	0	0	0	0	0	0	1.08E+01
Pu-238	1.72E-02	4.87E-01	7.73E-03	3.04E-04	0	0	0	0	0	0	4.34E+03
Pu-239	3.24E+00	4.27E-01	6.19E-03	2.71E-04	0	0	0	0	0	0	5.81E+01
Pu-240	2.67E-05	6.16E-04	1.05E-05	6.38E-06	0	0	0	0	0	0	5.48E+01
Pu-241	1.47E-01	4.72E+00	7.15E-02	3.15E-03	0	0	0	0	0	0	1.89E+03
Am-241	2.63E-02	8.68E-01	1.30E-02	5.64E-04	0	0	0	0	0	0	1.88E+02
Cm-242	0	7.34E-08	0	2.40E-08	0	0	0	0	0	0	1.41E-06
Total	169.12	827.23	78.25	0.77	0	0	0	0	0	0	14,389.95

Table 4A-10. SDA Trench 10 Radionuclide Inventory (Page 1 of 4)

Nuclide	Curies per Trench Interval (feet from North end)									
	0 - 49	50 - 99	100 - 149	150 - 199	200 - 249	250 - 299	300 - 349	350 - 399		
H-3	9.23E+02	4.57E+02	2.34E+02	7.27E+02	1.25E+03	5.62E+02	8.42E+00	5.45E+02		
C-14	4.03E+00	2.00E+00	1.04E+00	3.16E+00	1.23E+00	1.42E+01	2.39E+00	2.32E+00		
Fe-55	5.59E-04	1.72E-03	4.57E-04	4.40E-03	1.85E-03	7.21E-04	5.11E-04	1.71E-03		
Co-60	4.45E-02	1.34E+01	5.58E-02	2.96E-01	1.21E-01	5.68E-01	1.13E-01	9.04E-02		
Ni-59	9.85E-04	2.68E-03	6.40E-04	7.66E-03	2.97E-03	1.10E-03	2.04E-04	2.18E-03		
Ni-63	2.27E-01	1.69E-01	1.55E-01	2.59E+00	7.40E-01	2.71E-01	2.95E-02	2.23E-01		
Kr-85	0	0	0	0	0	0	0	0		
Sr-90	4.99E-02	1.44E-01	2.17E-01	4.83E-01	4.28E-01	6.59E+00	1.90E+00	3.99E-01		
Y-90	4.99E-02	1.44E-01	2.18E-01	4.83E-01	4.28E-01	6.60E+00	1.90E+00	3.99E-01		
Zr-93	2.03E-07	4.13E-06	9.75E-06	1.31E-05	1.75E-05	1.04E-05	3.16E-05	1.83E-05		
Nb-94	3.12E-05	8.42E-05	1.93E-05	2.41E-04	9.22E-05	3.37E-05	3.33E-06	6.71E-05		
Tc-99	9.17E-05	1.63E-04	1.15E-04	1.76E-03	2.99E-04	1.53E-04	2.29E-04	2.99E-04		
I-129	2.63E-04	3.68E-04	1.40E-04	4.94E-03	5.20E-04	2.10E-04	2.93E-05	4.94E-04		
Cs-135	8.95E-05	1.37E-04	5.00E-05	1.67E-03	1.81E-04	7.39E-05	1.87E-05	1.79E-04		
Cs-137	1.31E+00	2.04E+00	9.36E-01	2.34E+01	2.96E+00	7.56E+00	2.19E+00	2.92E+00		
Ba-137m	1.24E+00	1.93E+00	8.85E-01	2.22E+01	2.80E+00	7.15E+00	2.07E+00	2.77E+00		
Pm-147	8.48E-06	1.73E-04	4.07E-04	5.46E-04	1.22E-03	5.86E-04	1.55E-03	9.96E-04		
Ti-207	2.89E-08	1.75E-07	1.09E-05	5.54E-06	6.70E-07	9.26E-06	8.17E-06	2.75E-06		
Ti-208	3.60E-07	7.34E-06	1.73E-05	2.32E-05	4.12E-05	1.85E-05	5.64E-05	3.28E-05		
Pb-210	6.35E-03	1.92E-01	1.89E-02	3.01E-02	7.43E-04	1.47E-03	5.84E-03	1.49E-07		
Pb-211	2.90E-08	1.75E-07	1.09E-05	5.56E-06	6.72E-07	9.28E-06	8.19E-06	2.76E-06		
Pb-212	1.00E-06	2.04E-05	4.82E-05	6.46E-05	1.15E-04	5.14E-05	1.57E-04	9.12E-05		
Pb-214	1.07E-02	3.25E-01	3.20E-02	5.10E-02	1.26E-03	2.48E-03	9.88E-03	5.23E-07		
Bi-210	6.34E-03	1.92E-01	1.89E-02	3.01E-02	7.42E-04	1.46E-03	5.84E-03	1.49E-07		
Bi-211	2.90E-08	1.75E-07	1.09E-05	5.56E-06	6.72E-07	9.28E-06	8.19E-06	2.76E-06		
Bi-212	1.00E-06	2.04E-05	4.82E-05	6.46E-05	1.15E-04	5.14E-05	1.57E-04	9.12E-05		
Bi-214	1.07E-02	3.25E-01	3.20E-02	5.10E-02	1.26E-03	2.48E-03	9.88E-03	5.23E-07		
Po-210	6.27E-03	1.89E-01	1.87E-02	2.98E-02	7.33E-04	1.45E-03	5.77E-03	1.43E-07		
Po-212	0	0	0	0	0	0	0	0		
Po-214	1.07E-02	3.25E-01	3.20E-02	5.10E-02	1.26E-03	2.48E-03	9.87E-03	5.23E-07		
Po-215	0	0	0	0	0	0	0	0		
Po-216	1.00E-06	2.04E-05	4.82E-05	6.46E-05	1.15E-04	5.14E-05	1.57E-04	9.12E-05		
Po-218	1.07E-02	3.25E-01	3.20E-02	5.10E-02	1.26E-03	2.48E-03	9.88E-03	5.23E-07		
Rn-219	2.90E-08	1.75E-07	1.09E-05	5.56E-06	6.72E-07	9.28E-06	8.19E-06	2.76E-06		
Rn-220	1.00E-06	2.04E-05	4.82E-05	6.46E-05	1.15E-04	5.14E-05	1.57E-04	9.12E-05		

Table 4A-10. SDA Trench 10 Radionuclide Inventory (Page 2 of 4)

Nuclide	Curies per Trench Interval (feet from North end)									
	0 - 49	50 - 99	100 - 149	150 - 199	200 - 249	250 - 299	300 - 349	350 - 399		
Rn-222	1.07E-02	3.25E-01	3.20E-02	5.10E-02	1.26E-03	2.48E-03	9.88E-03	5.23E-07		
Ra-223	2.90E-08	1.75E-07	1.09E-05	5.56E-06	6.72E-07	9.28E-06	8.19E-06	2.76E-06		
Ra-224	1.00E-06	2.04E-05	4.82E-05	6.46E-05	1.15E-04	5.14E-05	1.57E-04	9.12E-05		
Ra-226	1.07E-02	3.25E-01	3.20E-02	5.10E-02	1.26E-03	2.48E-03	9.88E-03	5.24E-07		
Ra-228	1.30E-09	2.65E-08	6.24E-08	8.36E-08	2.86E-05	6.66E-08	2.02E-07	1.17E-07		
Ac-227	2.91E-08	1.75E-07	1.10E-05	5.60E-06	6.73E-07	9.35E-06	8.25E-06	2.78E-06		
Ac-228	1.30E-09	2.65E-08	6.24E-08	8.36E-08	2.86E-05	6.66E-08	2.02E-07	1.17E-07		
Th-227	2.86E-08	1.73E-07	1.08E-05	5.50E-06	6.63E-07	9.18E-06	8.10E-06	2.73E-06		
Th-228	1.00E-06	2.04E-05	4.82E-05	6.45E-05	1.15E-04	5.14E-05	1.57E-04	9.12E-05		
Th-230	3.24E-05	3.08E-05	3.50E-04	2.25E-04	3.19E-05	3.40E-04	2.64E-04	7.49E-05		
Th-231	1.03E-04	7.69E-05	5.15E-02	2.46E-02	1.24E-05	4.33E-02	3.60E-02	1.07E-02		
Th-232	1.33E-09	2.70E-08	6.37E-08	8.54E-08	2.96E-05	6.80E-08	2.07E-07	1.20E-07		
Th-234	4.01E-05	2.73E-05	2.08E+00	1.73E+00	1.03E-04	3.02E+00	2.34E+00	6.97E-01		
Pa-231	7.45E-08	2.99E-07	3.16E-05	1.57E-05	1.07E-06	2.67E-05	2.30E-05	7.36E-06		
Pa-234m	4.01E-05	2.73E-05	2.08E+00	1.73E+00	1.03E-04	3.02E+00	2.34E+00	6.97E-01		
U-233	2.07E-06	4.21E-05	9.93E-05	1.33E-04	1.78E-04	1.06E-04	3.22E-04	1.86E-04		
U-234	2.45E-01	2.33E-01	1.42E+00	9.93E-01	2.39E-01	1.34E+00	1.06E+00	3.03E-01		
U-235	1.03E-04	7.69E-05	5.15E-02	2.46E-02	1.24E-05	4.33E-02	3.60E-02	1.07E-02		
U-238	4.01E-05	2.73E-05	2.08E+00	1.73E+00	1.03E-04	3.02E+00	2.34E+00	6.97E-01		
Pu-238	2.72E+03	2.58E+03	1.38E+03	2.69E+03	2.64E+03	3.13E+02	1.07E-02	9.66E-03		
Pu-239	2.01E-03	1.29E-01	5.51E-03	4.31E-02	1.19E-02	6.34E-03	1.47E-02	2.57E+00		
Pu-240	6.88E-05	1.35E-03	3.17E-03	4.30E-03	5.68E-03	3.38E-03	1.03E-02	5.95E-03		
Pu-241	2.70E-02	7.43E-02	1.44E-01	5.93E-01	2.92E-01	1.61E-01	4.37E-01	2.93E-01		
Am-241	4.75E-03	9.39E-03	1.08E+01	9.54E-02	3.47E-02	2.38E-02	4.64E-02	3.20E-02		
Cm-242	2.63E-07	5.36E-06	1.26E-05	1.69E-05	2.27E-05	1.35E-05	4.11E-05	2.38E-05		
Total	3,646.11	3,062.71	1,635.81	3,474.32	3,896.76	927.89	27.78	559.54		

Table 4A-10. SDA Trench 10 Radionuclide Inventory (Page 3 of 4)

Nuclide	Curies per Trench Interval (feet from North end)										Total
	400 - 449	450 - 499	500 - 549	550 - 599	600 - 649	650 - 699	700 - 750				
H-3	1.38E+01	2.35E+03	1.92E+01	1.03E+00	0	0	0	0	0	0	7.08E+03
C-14	5.45E-01	9.98E+00	8.97E-02	2.66E-01	0	0	0	0	0	0	4.12E+01
Fe-55	5.17E-03	3.12E-03	3.56E-03	1.53E-02	0	0	0	0	0	0	3.91E-02
Co-60	1.41E-01	2.14E-01	2.14E-01	1.78E-01	0	0	0	0	0	0	1.55E+01
Ni-59	2.67E-03	4.10E-03	4.85E-03	3.80E-03	0	0	0	0	0	0	3.38E-02
Ni-63	6.87E-01	1.03E+00	1.23E+00	1.15E+00	0	0	0	0	0	0	8.51E+00
Kr-85	0	0	0	0	0	0	0	0	0	0	0
Sr-90	1.44E+00	4.48E-01	1.53E-01	1.32E+00	0	0	0	0	0	0	1.36E+01
Y-90	1.44E+00	4.48E-01	1.53E-01	1.32E+00	0	0	0	0	0	0	1.36E+01
Zr-93	4.50E-05	1.32E-05	4.85E-06	4.65E-04	0	0	0	0	0	0	6.33E-04
Nb-94	8.00E-05	1.28E-04	1.53E-04	1.20E-04	0	0	0	0	0	0	1.05E-03
Tc-99	7.27E-04	3.36E-04	3.27E-04	3.33E-04	0	0	0	0	0	0	4.83E-03
I-129	1.18E-03	7.12E-04	8.52E-04	6.69E-04	0	0	0	0	0	0	1.04E-02
Cs-135	4.29E-04	2.44E-04	2.90E-04	3.04E-04	0	0	0	0	0	0	3.67E-03
Cs-137	7.23E+00	3.91E+00	4.23E+00	4.16E+00	0	0	0	0	0	0	6.29E+01
Ba-137m	6.84E+00	3.69E+00	4.00E+00	3.94E+00	0	0	0	0	0	0	5.95E+01
Pm-147	3.62E-03	7.48E-01	2.64E-04	5.75E-03	0	0	0	0	0	0	7.64E-01
Ti-207	4.21E-06	1.31E-06	9.43E-06	2.77E-07	0	0	0	0	0	0	5.27E-05
Ti-208	8.07E-05	2.37E-05	1.83E-01	6.54E-06	0	0	0	0	0	0	1.83E-01
Pb-210	2.40E-03	6.68E-02	2.31E-03	1.22E-01	0	0	0	0	0	0	4.49E-01
Pb-211	4.22E-06	1.32E-06	9.46E-06	2.77E-07	0	0	0	0	0	0	5.29E-05
Pb-212	2.24E-04	6.59E-05	5.08E-01	1.82E-05	0	0	0	0	0	0	5.09E-01
Pb-214	4.16E-03	1.16E-01	4.00E-03	2.11E-01	0	0	0	0	0	0	7.67E-01
Po-210	2.37E-03	6.59E-02	2.28E-03	1.21E-01	0	0	0	0	0	0	4.43E-01
Po-212	0	0	3.25E-01	0	0	0	0	0	0	0	3.25E-01
Po-214	4.16E-03	1.16E-01	4.00E-03	2.11E-01	0	0	0	0	0	0	7.67E-01
Po-215	4.22E-06	1.32E-06	9.46E-06	0	0	0	0	0	0	0	5.17E-05
Po-216	2.24E-04	6.59E-05	5.08E-01	1.82E-05	0	0	0	0	0	0	5.09E-01
Po-218	4.16E-03	1.16E-01	4.01E-03	2.11E-01	0	0	0	0	0	0	7.67E-01
Rn-219	4.22E-06	1.32E-06	9.46E-06	2.77E-07	0	0	0	0	0	0	5.29E-05
Rn-220	2.24E-04	6.59E-05	5.08E-01	1.82E-05	0	0	0	0	0	0	5.09E-01

Table 4A-10. SDA Trench 10 Radionuclide Inventory (Page 4 of 4)

Nuclide	Curies per Trench Interval (feet from North end)										Total	
	400 - 449	450 - 499	500 - 549	550 - 599	600 - 649	650 - 699	700 - 750					
Rn-222	4.16E-03	1.16E-01	4.01E-03	2.11E-01	0	0	0	0	0	0	0	7.67E-01
Ra-223	4.22E-06	1.32E-06	9.46E-06	2.77E-07	0	0	0	0	0	0	0	5.29E-05
Ra-224	2.24E-04	6.59E-05	5.08E-01	1.82E-05	0	0	0	0	0	0	0	5.09E-01
Ra-226	4.16E-03	1.16E-01	4.01E-03	2.11E-01	0	0	0	0	0	0	0	7.67E-01
Ra-228	2.87E-07	8.42E-08	5.18E-01	2.33E-08	0	0	0	0	0	0	0	5.18E-01
Ac-227	4.24E-06	1.32E-06	9.53E-06	2.79E-07	0	0	0	0	0	0	0	5.32E-05
Ac-228	2.87E-07	8.42E-08	5.18E-01	2.33E-08	0	0	0	0	0	0	0	5.18E-01
Th-227	4.17E-06	1.30E-06	9.35E-06	2.74E-07	0	0	0	0	0	0	0	5.23E-05
Th-228	2.24E-04	6.59E-05	5.08E-01	1.82E-05	0	0	0	0	0	0	0	5.09E-01
Th-230	8.85E-05	2.20E-05	3.63E-04	1.14E-09	0	0	0	0	0	0	0	1.82E-03
Th-231	1.31E-02	4.25E-03	4.81E-02	7.25E-04	0	0	0	0	0	0	0	2.33E-01
Th-232	2.94E-07	8.63E-08	5.37E-01	2.38E-08	0	0	0	0	0	0	0	5.37E-01
Th-234	7.16E-01	9.07E-02	3.36E+00	1.17E-04	0	0	0	0	0	0	0	1.40E+01
Pa-231	1.04E-05	3.27E-06	2.83E-05	6.44E-07	0	0	0	0	0	0	0	1.48E-04
Pa-234m	7.16E-01	9.07E-02	3.36E+00	1.17E-04	0	0	0	0	0	0	0	1.40E+01
U-233	4.58E-04	1.35E-04	4.95E-05	3.71E-05	0	0	0	0	0	0	0	1.75E-03
U-234	3.58E-01	8.88E-02	1.47E+00	2.50E-06	0	0	0	0	0	0	0	7.75E+00
U-235	1.31E-02	4.25E-03	4.81E-02	7.25E-04	0	0	0	0	0	0	0	2.33E-01
U-238	7.16E-01	9.07E-02	3.36E+00	1.17E-04	0	0	0	0	0	0	0	1.40E+01
Pu-238	2.54E-02	1.17E-02	1.04E-02	8.16E-03	0	0	0	0	0	0	0	1.23E+04
Pu-239	2.95E-02	1.14E-02	8.64E-03	6.71E-03	0	0	0	0	0	0	0	2.84E+00
Pu-240	1.46E-02	4.30E-03	1.59E-03	1.19E-03	0	0	0	0	0	0	0	5.59E-02
Pu-241	7.40E-01	2.65E-01	1.63E-01	1.26E-01	0	0	0	0	0	0	0	3.32E+00
Am-241	8.25E-02	3.20E-02	2.27E-02	1.77E-02	0	0	0	0	0	0	0	1.12E+01
Cm-242	5.85E-05	1.72E-05	6.32E-06	4.74E-06	0	0	0	0	0	0	0	2.23E-04
Total	35.58	2,368.16	46.30	15.19	0	0	0	0	0	0	0	19,696.14

Table 4A-11. SDA Trench 11 Radionuclide Inventory (Page 1 of 4)

Nuclide	Curies per Trench Interval (feet from North end)									
	0 - 49	50 - 99	100 - 149	150 - 199	200 - 249	250 - 299	300 - 349	350 - 399		
H-3	5.91E+02	6.19E-01	2.94E+02	2.37E+03	1.50E+03	6.23E+02	4.29E-01	2.64E+02		
C-14	2.67E+00	1.67E-01	1.30E+00	9.79E+00	7.78E+00	2.54E+00	1.08E-01	1.24E+00		
Fe-55	1.13E-02	1.48E-01	2.17E-02	3.55E-03	2.93E-02	1.07E-03	6.03E-03	3.13E-03		
Co-60	6.19E-01	7.79E+00	1.12E+00	2.13E-01	1.84E+00	7.10E-02	9.90E-02	1.95E-01		
Ni-59	1.39E-02	1.78E-01	2.54E-02	4.58E-03	4.06E-02	1.42E-03	2.17E-03	4.34E-03		
Ni-63	1.22E+00	3.85E+00	6.52E+00	1.15E+00	1.03E+01	3.59E-01	6.17E-01	1.11E+00		
Kr-85	0	1.35E+00	0	0	0	0	0	0		
Sr-90	4.56E-01	2.85E-01	9.71E-01	4.86E-01	1.13E+00	1.47E-01	4.88E-01	1.04E-01		
Y-90	4.56E-01	2.85E-01	9.71E-01	4.87E-01	1.13E+00	1.47E-01	4.89E-01	1.04E-01		
Zr-93	1.29E-05	3.71E-06	6.49E-04	7.42E-02	6.81E-06	9.27E-04	1.78E-03	5.05E-07		
Nb-94	4.37E-04	5.63E-03	8.03E-04	1.43E-04	1.28E-03	4.45E-05	6.84E-05	1.37E-04		
Tc-99	7.78E-04	7.78E-03	1.68E-03	4.37E-04	2.52E-03	1.15E-04	1.70E-04	2.70E-04		
I-129	1.90E-03	2.07E-02	4.53E-03	9.24E-04	7.17E-03	2.66E-04	3.82E-04	7.75E-04		
Cs-135	6.99E-04	7.94E-03	1.56E-03	3.19E-04	2.43E-03	9.08E-05	1.57E-04	2.62E-04		
Cs-137	1.02E+01	1.10E+02	2.24E+01	5.00E+00	3.56E+01	2.33E+00	2.34E+00	3.78E+00		
Ba-137m	9.62E+00	1.04E+02	2.11E+01	4.73E+00	3.36E+01	2.20E+00	2.21E+00	3.58E+00		
Pm-147	7.04E-04	2.02E-04	2.25E-03	9.52E-04	3.71E-04	1.88E-04	2.06E-03	2.75E-05		
Ti-207	2.07E-06	1.53E-07	6.63E-06	3.05E-06	9.64E-06	2.01E-06	1.17E-07	1.35E-06		
Ti-208	2.32E-05	6.64E-06	1.70E-03	3.10E-05	3.17E-02	6.18E-06	2.93E-06	5.92E-03		
Pb-210	1.72E-03	3.16E-01	8.34E-03	1.27E-02	2.97E-01	5.05E-02	1.71E-03	2.27E-01		
Pb-211	2.08E-06	1.54E-07	6.65E-06	3.06E-06	9.66E-06	2.01E-06	1.17E-07	1.35E-06		
Pb-212	6.45E-05	1.85E-05	4.72E-03	8.63E-05	8.82E-02	1.72E-05	8.16E-06	1.65E-02		
Pb-214	2.97E-03	5.46E-01	1.44E-02	2.19E-02	5.14E-01	8.74E-02	2.96E-03	3.93E-01		
Bi-210	1.72E-03	3.16E-01	8.33E-03	1.26E-02	2.97E-01	5.05E-02	1.71E-03	2.27E-01		
Bi-211	2.08E-06	1.54E-07	6.65E-06	3.06E-06	9.66E-06	2.01E-06	1.17E-07	1.35E-06		
Bi-212	6.45E-05	1.85E-05	4.72E-03	8.63E-05	8.82E-02	1.72E-05	8.16E-06	1.65E-02		
Bi-214	2.97E-03	5.46E-01	1.44E-02	2.19E-02	5.14E-01	8.74E-02	2.96E-03	3.93E-01		
Po-210	1.70E-03	3.12E-01	8.23E-03	1.25E-02	2.93E-01	4.99E-02	1.69E-03	2.24E-01		
Po-212	0	0	0	0	5.65E-02	0	0	1.06E-02		
Po-214	2.97E-03	5.46E-01	1.44E-02	2.19E-02	5.14E-01	8.74E-02	2.96E-03	3.93E-01		
Po-215	2.08E-06	0	6.65E-06	3.06E-06	9.66E-06	2.01E-06	0	1.35E-06		
Po-216	6.45E-05	1.85E-05	4.72E-03	8.63E-05	8.82E-02	1.72E-05	8.16E-06	1.65E-02		
Po-218	2.97E-03	5.46E-01	1.44E-02	2.19E-02	5.14E-01	8.74E-02	2.96E-03	3.93E-01		
Rn-219	2.08E-06	1.54E-07	6.65E-06	3.06E-06	9.66E-06	2.01E-06	1.17E-07	1.35E-06		
Rn-220	6.45E-05	1.85E-05	4.72E-03	8.63E-05	8.82E-02	1.72E-05	8.16E-06	1.65E-02		

Table 4A-11. SDA Trench 11 Radionuclide Inventory (Page 2 of 4)

Nuclide	Curies per Trench Interval (feet from North end)									
	0 - 49	50 - 99	100 - 149	150 - 199	200 - 249	250 - 299	300 - 349	350 - 399		
Rn-222	2.97E-03	5.46E-01	1.44E-02	2.19E-02	5.14E-01	8.74E-02	2.96E-03	3.93E-01		
Ra-223	2.08E-06	1.54E-07	6.65E-06	3.06E-06	9.66E-06	2.01E-06	1.17E-07	1.35E-06		
Ra-224	6.45E-05	1.85E-05	4.72E-03	8.63E-05	8.82E-02	1.72E-05	8.16E-06	1.65E-02		
Ra-226	2.97E-03	5.46E-01	1.44E-02	2.19E-02	5.14E-01	8.74E-02	2.96E-03	3.93E-01		
Ra-228	8.24E-08	2.36E-08	4.73E-03	1.10E-07	8.99E-02	2.20E-08	1.04E-08	1.68E-02		
Ac-227	2.09E-06	1.54E-07	6.70E-06	3.08E-06	9.73E-06	2.03E-06	1.18E-07	1.36E-06		
Ac-228	8.24E-08	2.36E-08	4.73E-03	1.10E-07	8.99E-02	2.20E-08	1.04E-08	1.68E-02		
Th-227	2.05E-06	1.52E-07	6.57E-06	3.03E-06	9.55E-06	1.99E-06	1.16E-07	1.33E-06		
Th-228	6.45E-05	1.85E-05	4.72E-03	8.63E-05	8.82E-02	1.72E-05	8.16E-06	1.65E-02		
Th-230	6.60E-05	5.41E-05	2.38E-04	7.22E-05	3.68E-04	5.00E-05	4.56E-07	5.07E-05		
Th-231	8.24E-03	7.12E-05	3.16E-02	1.25E-02	4.88E-02	9.78E-03	2.89E-04	6.90E-03		
Th-232	8.45E-08	2.42E-08	4.91E-03	1.13E-07	9.33E-02	2.25E-08	1.07E-08	1.74E-02		
Th-234	5.67E-01	3.74E-04	2.20E+00	6.63E-01	3.42E+00	2.06E-01	4.27E-03	4.52E-01		
Pa-231	5.58E-06	2.67E-07	1.93E-05	8.32E-06	2.88E-05	5.90E-06	2.68E-07	4.05E-06		
Pa-234m	5.67E-01	3.74E-04	2.20E+00	6.63E-01	3.42E+00	2.06E-01	4.27E-03	4.52E-01		
U-233	1.32E-04	3.78E-05	1.54E-04	1.76E-04	6.94E-05	3.51E-05	1.67E-05	5.14E-06		
U-234	2.86E-01	4.22E-01	9.69E-01	2.92E-01	1.49E+00	2.02E-01	1.84E-03	2.05E-01		
U-235	8.24E-03	7.12E-05	3.16E-02	1.25E-02	4.88E-02	9.78E-03	2.89E-04	6.90E-03		
U-238	5.67E-01	3.74E-04	2.20E+00	6.63E-01	3.42E+00	2.06E-01	4.27E-03	4.52E-01		
Pu-238	4.58E+02	4.85E+03	1.84E+02	1.50E-02	7.66E-02	4.48E-03	2.07E-02	8.18E-03		
Pu-239	2.99E-02	5.20E-02	4.10E-02	1.49E-02	5.71E-02	4.08E-03	1.67E-02	6.07E-03		
Pu-240	2.06E-02	1.35E-03	4.96E-03	5.63E-03	2.29E-03	1.65E-03	1.43E-02	1.73E-04		
Pu-241	8.87E-01	7.12E-01	7.15E-01	3.42E-01	8.94E-01	9.64E-02	5.58E-01	9.31E-02		
Am-241	9.06E-02	8.63E+00	1.05E-01	4.11E-02	1.43E-01	1.15E-02	5.34E-02	1.51E-02		
Cm-242	1.68E-05	4.82E-06	1.97E-05	2.25E-05	8.86E-06	4.49E-06	2.13E-06	6.57E-07		
Total	1,077.78	5,090.48	541.24	2,398.27	1,604.43	632.55	7.50	279.31		

Table 4A-11. SDA Trench 11 Radionuclide Inventory (Page 3 of 4)

Nuclide	Curies per Trench Interval (feet from North end)										Total
	400 - 449	450 - 499	500 - 549	550 - 599	600 - 649	650 - 699	700 - 750				
H-3	1.52E+03	2.23E+01	1.45E+03	2.49E+00	0	0	0	0	0	0	8.64E+03
C-14	7.45E+00	5.45E-01	6.44E+00	6.73E-01	0	0	0	0	0	0	4.07E+01
Fe-55	1.27E-01	2.54E-02	6.10E-03	1.18E-05	0	0	0	0	0	0	3.83E-01
Co-60	7.68E+00	3.20E-01	3.90E-01	3.43E-02	0	0	0	0	0	0	2.04E+01
Ni-59	1.76E-01	6.66E-03	8.45E-03	1.03E-05	0	0	0	0	0	0	4.62E-01
Ni-63	4.48E+01	2.00E+00	2.15E+00	2.40E-03	0	0	0	0	0	0	7.41E+01
Kr-85	0	0	0	0	0	0	0	0	0	0	1.35E+00
Sr-90	1.44E+00	2.06E+00	3.08E-01	2.09E-01	0	0	0	0	0	0	8.10E+00
Y-90	1.44E+00	2.06E+00	3.08E-01	2.09E-01	0	0	0	0	0	0	8.10E+00
Zr-93	4.15E-06	4.14E-05	1.19E-06	3.07E-07	0	0	0	0	0	0	7.76E-02
Nb-94	5.56E-03	2.10E-04	2.67E-04	2.95E-07	0	0	0	0	0	0	1.46E-02
Tc-99	1.07E-02	5.56E-04	5.46E-04	3.11E-06	0	0	0	0	0	0	2.56E-02
I-129	3.11E-02	1.18E-03	1.56E-03	1.56E-06	0	0	0	0	0	0	7.04E-02
Cs-135	1.05E-02	5.28E-04	5.29E-04	6.13E-07	0	0	0	0	0	0	2.50E-02
Cs-137	1.49E+02	7.23E+00	7.73E+00	3.49E-01	0	0	0	0	0	0	3.55E+02
Ba-137m	1.41E+02	6.84E+00	7.31E+00	3.30E-01	0	0	0	0	0	0	3.36E+02
Pm-147	2.26E-04	1.30E-02	6.48E-05	1.78E-05	0	0	0	0	0	0	2.00E-02
Ti-207	3.58E-07	1.21E-05	9.98E-08	1.15E-08	0	0	0	0	0	0	3.76E-05
Ti-208	7.44E-06	1.20E-04	2.13E-06	3.34E-04	0	0	0	0	0	0	3.99E-02
Pb-210	4.29E-03	2.00E-03	6.29E-04	2.49E-03	0	0	0	0	0	0	9.24E-01
Pb-211	3.59E-07	1.21E-05	1.00E-07	1.15E-08	0	0	0	0	0	0	3.77E-05
Pb-212	2.07E-05	3.35E-04	5.94E-06	9.30E-04	0	0	0	0	0	0	1.11E-01
Pb-214	7.42E-03	3.47E-03	1.09E-03	4.31E-03	0	0	0	0	0	0	1.60E+00
Bi-210	4.29E-03	2.00E-03	6.29E-04	2.49E-03	0	0	0	0	0	0	9.24E-01
Bi-211	3.59E-07	1.21E-05	1.00E-07	1.15E-08	0	0	0	0	0	0	3.77E-05
Bi-212	2.07E-05	3.35E-04	5.94E-06	9.30E-04	0	0	0	0	0	0	1.11E-01
Bi-214	7.42E-03	3.47E-03	1.09E-03	4.31E-03	0	0	0	0	0	0	1.60E+00
Po-210	4.23E-03	1.98E-03	6.21E-04	2.46E-03	0	0	0	0	0	0	9.12E-01
Po-212	0	0	0	0	0	0	0	0	0	0	6.71E-02
Po-214	7.42E-03	3.47E-03	1.09E-03	4.31E-03	0	0	0	0	0	0	1.60E+00
Po-215	0	1.21E-05	0	0	0	0	0	0	0	0	3.69E-05
Po-216	2.07E-05	3.35E-04	5.94E-06	9.30E-04	0	0	0	0	0	0	1.11E-01
Po-218	7.43E-03	3.47E-03	1.09E-03	4.31E-03	0	0	0	0	0	0	1.60E+00
Rn-219	3.59E-07	1.21E-05	1.00E-07	1.15E-08	0	0	0	0	0	0	3.77E-05
Rn-220	2.07E-05	3.35E-04	5.94E-06	9.30E-04	0	0	0	0	0	0	1.11E-01

Table 4A-11. SDA Trench 11 Radionuclide Inventory (Page 4 of 4)

Nuclide	Curies per Trench Interval (feet from North end)										Total
	400 - 449	450 - 499	500 - 549	550 - 599	600 - 649	650 - 699	700 - 750				
Rn-222	7.43E-03	3.47E-03	1.09E-03	4.31E-03	0	0	0	0	0	0	1.60E+00
Ra-223	3.59E-07	1.21E-05	1.00E-07	1.15E-08	0	0	0	0	0	0	3.77E-05
Ra-224	2.07E-05	3.35E-04	5.94E-06	9.30E-04	0	0	0	0	0	0	1.11E-01
Ra-226	7.43E-03	3.47E-03	1.09E-03	4.31E-03	0	0	0	0	0	0	1.60E+00
Ra-228	2.65E-08	3.26E-04	7.59E-09	9.46E-04	0	0	0	0	0	0	1.13E-01
Ac-227	3.61E-07	1.22E-05	1.01E-07	1.16E-08	0	0	0	0	0	0	3.79E-05
Ac-228	2.65E-08	3.26E-04	7.59E-09	9.46E-04	0	0	0	0	0	0	1.13E-01
Th-227	3.55E-07	1.20E-05	9.89E-08	1.14E-08	0	0	0	0	0	0	3.72E-05
Th-228	2.07E-05	3.35E-04	5.94E-06	9.30E-04	0	0	0	0	0	0	1.11E-01
Th-230	7.45E-09	4.63E-04	5.27E-10	8.89E-11	0	0	0	0	0	0	1.36E-03
Th-231	1.05E-03	6.22E-02	2.86E-04	6.23E-08	0	0	0	0	0	0	1.82E-01
Th-232	2.71E-08	3.38E-04	7.78E-09	9.82E-04	0	0	0	0	0	0	1.17E-01
Th-234	5.03E-03	4.31E+00	2.53E-04	5.92E-07	0	0	0	0	0	0	1.18E+01
Pa-231	8.64E-07	3.64E-05	2.39E-07	1.87E-08	0	0	0	0	0	0	1.10E-04
Pa-234m	5.03E-03	4.31E+00	2.53E-04	5.92E-07	0	0	0	0	0	0	1.18E+01
U-233	4.23E-05	3.14E-05	1.21E-05	3.13E-06	0	0	0	0	0	0	7.15E-04
U-234	4.11E-05	1.87E+00	2.03E-06	1.60E-07	0	0	0	0	0	0	5.74E+00
U-235	1.05E-03	6.22E-02	2.86E-04	6.23E-08	0	0	0	0	0	0	1.82E-01
U-238	5.03E-03	4.31E+00	2.53E-04	5.92E-07	0	0	0	0	0	0	1.18E+01
Pu-238	3.24E-01	1.33E-02	1.64E-02	1.18E-04	0	0	0	0	0	0	5.49E+03
Pu-239	2.36E-01	1.03E-02	1.23E-02	1.52E-04	0	0	0	0	0	0	4.80E-01
Pu-240	1.70E-03	1.02E-03	4.05E-04	9.97E-05	0	0	0	0	0	0	5.42E-02
Pu-241	3.52E+00	1.75E-01	1.89E-01	4.53E-03	0	0	0	0	0	0	8.18E+00
Am-241	5.82E-01	2.66E-02	3.05E-02	8.98E-04	0	0	0	0	0	0	9.73E+00
Cm-242	5.40E-06	4.02E-06	1.55E-06	4.00E-07	0	0	0	0	0	0	9.13E-05
Total	1,877.03	58.57	1,473.60	4.34	0	0	0	0	0	0	15,045.10

Table 4A-12. SDA Trench 12 Radionuclide Inventory (Page 1 of 4)

Nuclide	Curies per Trench Interval (feet from North end)									
	0 - 49	50 - 99	100 - 149	150 - 199	200 - 249	250 - 299	300 - 349	350 - 399		
H-3	1.04E+03	1.34E+02	1.17E+02	2.34E+02	7.64E+01	1.24E+02	3.18E+02	8.57E+00		
C-14	4.51E+00	7.68E-01	2.22E+00	5.13E-01	2.33E-01	6.32E-01	1.08E+01	3.69E-01		
Fe-55	1.11E-01	4.00E+00	1.72E-02	5.31E-02	3.50E-02	3.27E-02	3.57E-01	5.95E-03		
Co-60	3.23E+01	1.03E+02	5.30E+00	5.21E-01	1.67E+00	1.65E+00	8.44E+00	3.04E-01		
Ni-59	6.68E-02	1.43E+01	1.11E-02	9.98E-03	3.33E-02	3.29E-02	1.08E+00	5.68E-03		
Ni-63	9.16E+00	3.65E+02	2.73E+00	3.05E+00	2.03E+00	5.15E+00	2.95E+01	4.20E-01		
Kr-85	0	0	0	0	0	0	0	0		
Sr-90	5.62E+00	7.43E-01	1.29E+00	3.62E+00	2.24E-01	5.60E-01	3.81E+00	1.49E-01		
Y-90	5.62E+00	7.43E-01	1.29E+00	3.62E+00	2.24E-01	5.60E-01	3.81E+00	1.50E-01		
Zr-93	3.88E-03	1.64E-06	5.01E-06	8.42E-03	3.00E-06	4.28E-06	5.69E-05	1.28E-06		
Nb-94	9.14E-04	4.11E-03	3.50E-04	3.14E-04	1.05E-03	1.04E-03	5.77E-04	1.79E-04		
Tc-99	2.19E-03	7.28E-03	7.34E-04	9.07E-04	1.60E-03	3.22E-03	1.28E-03	2.87E-04		
I-129	5.22E-03	4.05E-03	1.93E-03	1.77E-03	4.30E-03	9.22E-03	1.71E-03	7.62E-04		
Cs-135	2.12E-03	1.39E-03	6.89E-04	8.08E-04	1.60E-03	3.19E-03	8.30E-04	2.81E-04		
Cs-137	2.92E+01	2.09E+01	1.12E+01	1.13E+01	2.29E+01	4.69E+01	1.13E+01	4.22E+00		
Ba-137m	2.76E+01	1.97E+01	1.06E+01	1.07E+01	2.17E+01	4.44E+01	1.07E+01	3.99E+00		
Pm-147	3.35E-02	2.06E-03	3.33E-03	2.04E-02	2.13E-04	3.03E-04	2.25E-02	9.08E-05		
Ti-207	1.07E-05	9.62E-08	3.19E-07	1.02E-06	1.92E-07	2.42E-07	1.22E-05	4.90E-08		
Ti-208	2.72E-02	2.96E-06	9.06E-06	2.40E-05	5.43E-06	7.74E-06	1.99E-05	2.32E-06		
Pb-210	2.17E-01	2.83E-01	1.99E-01	2.11E-01	6.70E-03	2.14E-01	9.48E-04	1.08E-03		
Pb-211	1.07E-05	9.65E-08	3.20E-07	1.03E-06	1.93E-07	2.42E-07	1.22E-05	4.92E-08		
Pb-212	7.56E-02	8.24E-06	2.52E-05	6.68E-05	1.51E-05	2.16E-05	5.54E-05	6.45E-06		
Pb-214	3.85E-01	5.02E-01	3.52E-01	3.75E-01	1.19E-02	3.79E-01	1.68E-03	1.91E-03		
Bi-210	2.17E-01	2.83E-01	1.99E-01	2.11E-01	6.69E-03	2.14E-01	9.47E-04	1.08E-03		
Bi-211	1.07E-05	9.65E-08	3.20E-07	1.03E-06	1.93E-07	2.42E-07	1.22E-05	4.92E-08		
Bi-212	7.56E-02	8.24E-06	2.52E-05	6.68E-05	1.51E-05	2.16E-05	5.54E-05	6.45E-06		
Bi-214	3.85E-01	5.02E-01	3.52E-01	3.75E-01	1.19E-02	3.79E-01	1.68E-03	1.91E-03		
Po-210	2.14E-01	2.80E-01	1.96E-01	2.08E-01	6.61E-03	2.11E-01	9.35E-04	1.06E-03		
Po-212	4.84E-02	0	0	0	0	0	0	0		
Po-214	3.85E-01	5.02E-01	3.52E-01	3.75E-01	1.19E-02	3.79E-01	1.68E-03	1.91E-03		
Po-215	1.07E-05	0	0	0	0	0	1.22E-05	0		
Po-216	7.56E-02	8.24E-06	2.52E-05	6.68E-05	1.51E-05	2.16E-05	5.54E-05	6.45E-06		
Po-218	3.85E-01	5.02E-01	3.52E-01	3.75E-01	1.19E-02	3.79E-01	1.68E-03	1.91E-03		
Rn-219	1.07E-05	9.65E-08	3.20E-07	1.03E-06	1.93E-07	2.42E-07	1.22E-05	4.92E-08		
Rn-220	7.56E-02	8.24E-06	2.52E-05	6.68E-05	1.51E-05	2.16E-05	5.54E-05	6.45E-06		

Table 4A-12. SDA Trench 12 Radionuclide Inventory (Page 2 of 4)

Nuclide	Curies per Trench Interval (feet from North end)									
	0 - 49	50 - 99	100 - 149	150 - 199	200 - 249	250 - 299	300 - 349	350 - 399		
Rn-222	3.85E-01	5.02E-01	3.52E-01	3.75E-01	1.19E-02	3.79E-01	1.68E-03	1.91E-03		
Ra-223	1.07E-05	9.65E-08	3.20E-07	1.03E-06	1.93E-07	2.42E-07	1.22E-05	4.92E-08		
Ra-224	7.56E-02	8.24E-06	2.52E-05	6.68E-05	1.51E-05	2.16E-05	5.54E-05	6.45E-06		
Ra-226	3.85E-01	5.02E-01	3.52E-01	3.75E-01	1.19E-02	3.79E-01	1.68E-03	1.91E-03		
Ra-228	7.72E-02	1.04E-08	3.18E-08	8.43E-08	1.91E-08	2.72E-08	4.77E-05	8.14E-09		
Ac-227	1.08E-05	9.69E-08	3.22E-07	1.03E-06	1.94E-07	2.43E-07	1.23E-05	4.93E-08		
Ac-228	7.72E-02	1.04E-08	3.18E-08	8.43E-08	1.91E-08	2.72E-08	4.77E-05	8.14E-09		
Th-227	1.06E-05	9.53E-08	3.16E-07	1.02E-06	1.91E-07	2.39E-07	1.21E-05	4.86E-08		
Th-228	7.56E-02	8.24E-06	2.52E-05	6.68E-05	1.51E-05	2.15E-05	5.54E-05	6.45E-06		
Th-230	4.00E-04	2.41E-09	2.64E-09	4.48E-09	1.59E-08	1.76E-06	4.74E-04	4.45E-08		
Th-231	5.87E-02	1.99E-04	7.46E-04	2.97E-03	4.54E-04	4.66E-04	6.74E-02	9.99E-06		
Th-232	8.05E-02	1.07E-08	3.27E-08	8.67E-08	1.96E-08	2.80E-08	4.97E-05	8.37E-09		
Th-234	3.79E+00	6.57E-04	3.06E-04	3.15E-04	2.89E-04	7.86E-03	4.57E+00	7.29E-05		
Pa-231	3.31E-05	2.11E-07	7.24E-07	2.47E-06	4.37E-07	5.22E-07	3.79E-05	8.36E-08		
Pa-234m	3.79E+00	6.57E-04	3.06E-04	3.15E-04	2.89E-04	7.86E-03	4.57E+00	7.29E-05		
U-233	3.10E-05	1.67E-05	5.10E-05	1.35E-04	3.06E-05	4.36E-05	1.77E-05	1.30E-05		
U-234	1.68E+00	1.07E-05	8.45E-06	1.05E-05	7.41E-05	8.18E-03	1.99E+00	1.88E-04		
U-235	5.87E-02	1.99E-04	7.46E-04	2.97E-03	4.54E-04	4.66E-04	6.74E-02	9.99E-06		
U-238	3.79E+00	6.57E-04	3.06E-04	3.15E-04	2.89E-04	7.86E-03	4.57E+00	7.29E-05		
Pu-238	5.56E-02	4.26E-02	2.12E-02	2.29E-02	2.37E-01	1.97E+01	1.07E-01	5.22E-02		
Pu-239	4.10E-02	3.13E-02	1.63E-02	1.94E-02	1.86E-01	1.57E+01	8.46E-02	1.08E+01		
Pu-240	1.29E-03	5.77E-04	1.65E-03	4.33E-03	1.79E-01	1.65E+01	7.70E-02	4.02E-02		
Pu-241	6.55E-01	4.94E-01	2.91E-01	4.02E-01	6.96E+00	6.20E+02	3.07E+00	1.55E+00		
Am-241	1.01E-01	7.65E-02	4.23E-02	5.11E-02	6.01E-01	5.20E+01	2.71E-01	1.34E-01		
Cm-242	3.97E-06	2.14E-06	6.55E-06	1.73E-05	3.92E-06	5.59E-06	2.28E-06	1.67E-06		
Total	1,171.76	667.31	154.74	270.24	133.70	951.05	417.29	30.75		

Table 4A-12. SDA Trench 12 Radionuclide Inventory (Page 3 of 4)

Nuclide	Curies per Trench Interval (feet from North end)										Total
	400 - 449	450 - 499	500 - 549	550 - 599	600 - 649	650 - 699	700 - 750				
H-3	2.18E+02	3.56E+00	7.61E+00	2.53E-02	0	0	0	0	0	0	2.28E+03
C-14	1.01E-01	8.86E-01	1.36E-01	6.45E-03	0	0	0	0	0	0	2.11E+01
Fe-55	5.06E-02	5.80E-02	6.87E-03	0	0	0	0	0	0	0	4.73E+00
Co-60	2.06E-01	5.15E-01	3.25E-01	3.66E-04	0	0	0	0	0	0	1.54E+02
Ni-59	4.06E-03	9.40E-03	6.38E-03	0	0	0	0	0	0	0	1.56E+01
Ni-63	1.56E+00	2.09E+00	1.29E-01	0	0	0	0	0	0	0	4.21E+02
Kr-85	0	0	0	0	0	0	0	0	0	0	0
Sr-90	3.33E+00	3.94E+00	6.78E-02	3.58E-03	0	0	0	0	0	0	2.34E+01
Y-90	3.33E+00	3.94E+00	6.78E-02	3.58E-03	0	0	0	0	0	0	2.34E+01
Zr-93	3.14E-07	1.95E-06	3.81E-07	0	0	0	0	0	0	0	1.24E-02
Nb-94	1.28E-04	2.97E-04	2.01E-04	0	0	0	0	0	0	0	9.17E-03
Tc-99	4.84E-04	7.61E-04	2.81E-04	4.83E-09	0	0	0	0	0	0	1.90E-02
I-129	7.52E-04	1.46E-03	7.43E-04	0	0	0	0	0	0	0	3.19E-02
Cs-135	4.78E-04	7.45E-04	2.85E-04	0	0	0	0	0	0	0	1.24E-02
Cs-137	5.93E+00	1.02E+01	4.11E+00	3.53E-03	0	0	0	0	0	0	1.78E+02
Ba-137m	5.61E+00	9.61E+00	3.89E+00	3.34E-03	0	0	0	0	0	0	1.68E+02
Pm-147	2.09E-02	2.18E-02	2.70E-05	0	0	0	0	0	0	0	1.25E-01
Ti-207	6.21E-07	8.18E-06	7.86E-08	0	0	0	0	0	0	0	3.37E-05
Ti-208	5.68E-07	2.24E-02	6.90E-07	0	0	0	0	0	0	0	4.97E-02
Pb-210	4.90E-02	2.83E-01	5.58E-02	0	0	0	0	0	0	0	1.52E+00
Pb-211	6.23E-07	8.21E-06	7.88E-08	0	0	0	0	0	0	0	3.38E-05
Pb-212	1.58E-06	6.24E-02	1.92E-06	0	0	0	0	0	0	0	1.38E-01
Pb-214	8.68E-02	5.01E-01	9.88E-02	0	0	0	0	0	0	0	2.69E+00
Po-210	4.83E-02	2.79E-01	5.50E-02	0	0	0	0	0	0	0	1.50E+00
Po-212	0	4.00E-02	0	0	0	0	0	0	0	0	8.84E-02
Po-214	8.68E-02	5.01E-01	9.88E-02	0	0	0	0	0	0	0	2.69E+00
Po-215	0	8.21E-06	0	0	0	0	0	0	0	0	3.11E-05
Po-216	1.58E-06	6.24E-02	1.92E-06	0	0	0	0	0	0	0	1.38E-01
Po-218	8.68E-02	5.01E-01	9.89E-02	0	0	0	0	0	0	0	2.70E+00
Rn-219	6.23E-07	8.21E-06	7.88E-08	0	0	0	0	0	0	0	3.38E-05
Rn-220	1.58E-06	6.24E-02	1.92E-06	0	0	0	0	0	0	0	1.38E-01

Table 4A-12. SDA Trench 12 Radionuclide Inventory (Page 4 of 4)

Nuclide	Curies per Trench Interval (feet from North end)										Total
	400 - 449	450 - 499	500 - 549	550 - 599	600 - 649	650 - 699	700 - 750				
Rn-222	8.68E-02	5.01E-01	9.89E-02	0	0	0	0	0	0	0	2.70E+00
Ra-223	6.23E-07	8.21E-06	7.88E-08	0	0	0	0	0	0	0	3.38E-05
Ra-224	1.58E-06	6.24E-02	1.92E-06	0	0	0	0	0	0	0	1.38E-01
Ra-226	8.68E-02	5.01E-01	9.89E-02	0	0	0	0	0	0	0	2.70E+00
Ra-228	2.00E-09	6.38E-02	2.42E-09	0	0	0	0	0	0	0	1.41E-01
Ac-227	6.28E-07	8.27E-06	7.93E-08	0	0	0	0	0	0	0	3.40E-05
Ac-228	2.00E-09	6.38E-02	2.42E-09	0	0	0	0	0	0	0	1.41E-01
Th-227	6.16E-07	8.12E-06	7.79E-08	0	0	0	0	0	0	0	3.34E-05
Th-228	1.58E-06	6.24E-02	1.92E-06	0	0	0	0	0	0	0	1.38E-01
Th-230	5.18E-06	3.14E-04	1.99E-09	0	0	0	0	0	0	0	1.19E-03
Th-231	3.39E-03	4.51E-02	3.58E-04	0	0	0	0	0	0	0	1.80E-01
Th-232	2.05E-09	6.65E-02	2.49E-09	0	0	0	0	0	0	0	1.47E-01
Th-234	2.00E-03	3.02E+00	2.02E-05	0	0	0	0	0	0	0	1.14E+01
Pa-231	1.92E-06	2.54E-05	2.24E-07	0	0	0	0	0	0	0	1.03E-04
Pa-234m	2.00E-03	3.02E+00	2.02E-05	0	0	0	0	0	0	0	1.14E+01
U-233	3.20E-06	1.99E-05	3.88E-06	1.38E-15	0	0	0	0	0	0	3.66E-04
U-234	2.17E-02	1.31E+00	9.25E-06	0	0	0	0	0	0	0	5.01E+00
U-235	3.39E-03	4.51E-02	3.58E-04	0	0	0	0	0	0	0	1.80E-01
U-238	2.00E-03	3.02E+00	2.02E-05	0	0	0	0	0	0	0	1.14E+01
Pu-238	7.87E-03	3.59E-01	2.95E-02	0	0	0	0	0	0	0	2.06E+01
Pu-239	5.76E-03	2.85E-01	2.30E-02	0	0	0	0	0	0	0	2.71E+01
Pu-240	1.10E-04	2.92E-01	2.24E-02	0	0	0	0	0	0	0	1.71E+01
Pu-241	9.11E-02	1.11E+01	8.64E-01	0	0	0	0	0	0	0	6.45E+02
Am-241	1.40E-02	9.40E-01	7.43E-02	2.74E-06	0	0	0	0	0	0	5.43E+01
Cm-242	4.10E-07	2.56E-06	4.98E-07	0	0	0	0	0	0	0	4.69E-05
Total	238.70	62.71	18.13	0.05	0	0	0	0	0	0	4,116.43

Table 4A-13. SDA Trench 13 Radionuclide Inventory (Page 1 of 4)

Nuclide	Curies per Trench Interval (feet from North end)									
	0 - 49	50 - 99	100 - 149	150 - 199	200 - 249	250 - 299	300 - 349	350 - 399		
H-3	1.04E+00	3.52E+02	1.81E+02	2.93E+01	2.52E+02	9.11E+01	1.75E+00	1.60E+02		
C-14	2.45E-01	1.07E-01	1.09E+00	3.26E-01	1.21E-01	1.87E-01	4.32E-02	5.93E-01		
Fe-55	4.68E-02	1.12E-02	1.48E-02	1.61E-02	1.10E-02	4.92E-02	2.21E-02	2.70E-02		
Co-60	2.62E-01	6.11E-01	6.63E-01	5.99E-01	5.02E-01	2.03E+00	2.84E+01	1.18E+00		
Ni-59	5.03E-03	1.10E-02	1.22E-02	1.15E-02	9.13E-03	3.55E-02	7.16E-03	2.05E-02		
Ni-63	1.77E+00	1.20E+00	1.35E+00	1.10E+00	1.18E+00	9.75E-01	8.27E-01	2.27E+00		
Kr-85	0	0	0	0	0	0	0	0		
Sr-90	3.10E+00	8.60E-02	8.30E-01	4.14E-01	8.37E-02	1.33E-01	1.15E+01	3.87E-01		
Y-90	3.10E+00	8.60E-02	8.30E-01	4.14E-01	8.37E-02	1.33E-01	1.15E+01	3.87E-01		
Zr-93	7.91E-07	6.79E-07	2.99E-03	9.12E-04	1.56E-07	9.89E-08	2.27E-07	3.42E-07		
Nb-94	1.59E-04	3.46E-04	3.87E-04	3.63E-04	2.88E-04	1.12E-03	2.26E-04	6.48E-04		
Tc-99	5.29E-04	5.65E-04	1.27E-03	5.83E-04	5.22E-04	1.56E-03	4.08E-04	2.59E-03		
I-129	9.41E-04	1.56E-03	3.62E-03	1.55E-03	1.47E-03	4.18E-03	9.96E-04	7.51E-03		
Cs-135	5.19E-04	5.63E-04	1.28E-03	5.81E-04	5.22E-04	1.60E-03	4.08E-04	2.60E-03		
Cs-137	6.71E+00	8.10E+00	1.88E+01	8.43E+00	7.65E+00	2.32E+01	5.77E+00	3.85E+01		
Ba-137m	6.35E+00	7.66E+00	1.78E+01	7.97E+00	7.24E+00	2.20E+01	5.46E+00	3.65E+01		
Pm-147	1.88E-02	4.82E-05	1.07E-03	1.79E-03	1.44E-05	9.14E-06	5.67E-03	3.16E-05		
Ti-207	3.53E-07	7.91E-06	1.24E-07	2.91E-06	8.19E-08	9.25E-08	3.00E-06	3.36E-08		
Ti-208	1.43E-06	5.40E-05	1.13E-03	1.78E-06	3.68E-05	2.66E-03	1.67E-02	6.65E-04		
Pb-210	3.36E-10	8.09E-03	7.51E-03	2.49E-02	7.05E-03	1.12E-01	2.72E-01	2.91E-11		
Pb-211	3.54E-07	7.93E-06	1.24E-07	2.91E-06	8.22E-08	9.28E-08	3.01E-06	3.37E-08		
Pb-212	3.98E-06	1.50E-04	3.14E-03	4.96E-06	1.03E-04	7.40E-03	4.64E-02	1.85E-03		
Pb-214	1.52E-09	1.43E-02	1.33E-02	4.41E-02	1.28E-02	2.03E-01	4.94E-01	1.32E-10		
Pb-214	1.52E-09	1.43E-02	1.33E-02	4.41E-02	1.28E-02	2.03E-01	4.94E-01	1.32E-10		
Bi-210	3.36E-10	8.08E-03	7.51E-03	2.49E-02	7.04E-03	1.11E-01	2.72E-01	2.90E-11		
Bi-211	3.54E-07	7.93E-06	1.24E-07	2.91E-06	8.22E-08	9.28E-08	3.01E-06	3.37E-08		
Bi-212	3.98E-06	1.50E-04	3.14E-03	4.96E-06	1.03E-04	7.40E-03	4.64E-02	1.85E-03		
Bi-214	1.52E-09	1.43E-02	1.33E-02	4.41E-02	1.28E-02	2.03E-01	4.94E-01	1.32E-10		
Po-210	3.16E-10	7.98E-03	7.41E-03	2.45E-02	6.94E-03	1.10E-01	2.68E-01	2.73E-11		
Po-212	0	0	0	0	0	0	2.97E-02	0		
Po-214	0	1.43E-02	1.33E-02	4.41E-02	1.28E-02	2.03E-01	4.94E-01	0		
Po-215	0	7.93E-06	0	2.91E-06	0	0	3.01E-06	0		
Po-216	3.98E-06	1.50E-04	3.14E-03	4.96E-06	1.03E-04	7.40E-03	4.64E-02	1.85E-03		
Po-218	1.52E-09	1.43E-02	1.33E-02	4.41E-02	1.28E-02	2.03E-01	4.95E-01	1.32E-10		
Rn-219	3.54E-07	7.93E-06	1.24E-07	2.91E-06	8.22E-08	9.28E-08	3.01E-06	3.37E-08		
Rn-220	3.98E-06	1.50E-04	3.14E-03	4.96E-06	1.03E-04	7.40E-03	4.64E-02	1.85E-03		

Table 4A-13. SDA Trench 13 Radionuclide Inventory (Page 2 of 4)

Nuclide	Curies per Trench Interval (feet from North end)									
	0 - 49	50 - 99	100 - 149	150 - 199	200 - 249	250 - 299	300 - 349	350 - 399		
Rn-222	1.52E-09	1.43E-02	1.33E-02	4.41E-02	1.28E-02	2.03E-01	4.95E-01	1.32E-10		
Ra-223	3.54E-07	7.93E-06	1.24E-07	2.91E-06	8.22E-08	9.28E-08	3.01E-06	3.37E-08		
Ra-224	3.98E-06	1.50E-04	3.14E-03	4.96E-06	1.03E-04	7.40E-03	4.64E-02	1.85E-03		
Ra-226	1.52E-09	1.43E-02	1.33E-02	4.41E-02	1.28E-02	2.03E-01	4.95E-01	1.32E-10		
Ra-228	5.03E-09	1.50E-04	3.20E-03	6.25E-09	1.04E-04	7.58E-03	4.76E-02	1.90E-03		
Ac-227	3.57E-07	8.00E-06	1.25E-07	2.94E-06	8.28E-08	9.35E-08	3.03E-06	3.39E-08		
Ac-228	5.03E-09	1.50E-04	3.20E-03	6.25E-09	1.04E-04	7.58E-03	4.76E-02	1.90E-03		
Th-227	3.50E-07	7.85E-06	1.23E-07	2.88E-06	8.13E-08	9.18E-08	2.98E-06	3.33E-08		
Th-228	3.98E-06	1.50E-04	3.14E-03	4.95E-06	1.03E-04	7.40E-03	4.64E-02	1.85E-03		
Th-230	2.79E-07	3.12E-04	2.86E-07	1.13E-04	2.67E-09	4.08E-07	1.18E-04	2.42E-08		
Th-231	1.84E-03	4.38E-02	5.81E-04	1.60E-02	4.54E-04	5.29E-04	1.78E-02	1.26E-04		
Th-232	5.17E-09	1.57E-04	3.34E-03	6.42E-09	1.09E-04	7.95E-03	4.99E-02	1.99E-03		
Th-234	1.18E-03	3.01E+00	1.66E-03	1.09E+00	1.62E-04	1.91E-03	1.19E+00	9.54E-04		
Pa-231	1.07E-06	2.46E-05	3.57E-07	9.01E-06	2.54E-07	2.91E-07	9.61E-06	8.89E-08		
Pa-234m	1.18E-03	3.01E+00	1.66E-03	1.09E+00	1.62E-04	1.91E-03	1.19E+00	9.54E-04		
U-233	8.06E-06	6.92E-06	5.23E-06	1.00E-05	1.59E-06	1.01E-06	2.31E-06	3.49E-06		
U-234	1.33E-03	1.31E+00	1.20E-03	4.74E-01	1.34E-05	1.78E-03	5.15E-01	1.07E-04		
U-235	1.84E-03	4.38E-02	5.81E-04	1.60E-02	4.54E-04	5.29E-04	1.78E-02	1.26E-04		
U-238	1.18E-03	3.01E+00	1.66E-03	1.09E+00	1.62E-04	1.91E-03	1.19E+00	9.54E-04		
Pu-238	4.00E+00	1.13E-02	2.78E-02	1.09E-02	4.92E-02	1.78E-02	7.09E-03	5.90E-02		
Pu-239	1.03E+01	7.98E-03	2.91E-02	1.32E-01	3.81E-02	1.10E-02	4.77E-03	4.90E-02		
Pu-240	3.36E+00	2.34E-04	2.00E-04	6.46E-04	3.17E-02	6.02E-05	8.21E-05	1.80E-04		
Pu-241	1.26E+02	1.24E-01	2.93E-01	1.31E-01	1.37E+00	1.62E-01	7.63E-02	6.37E-01		
Am-241	1.06E+01	1.90E-02	4.76E-02	1.87E-02	1.16E-01	2.37E-02	1.11E-02	9.84E-02		
Cm-242	1.03E-06	8.88E-07	6.71E-07	1.29E-06	2.04E-07	1.30E-07	2.98E-07	4.50E-07		
Total	176.76	380.59	223.21	52.98	270.76	141.62	73.76	241.04		

Table 4A-13. SDA Trench 13 Radionuclide Inventory (Page 3 of 4)

Nuclide	Curies per Trench Interval (feet from North end)										Total
	400 - 449	450 - 499	500 - 549	550 - 599	600 - 649	650 - 699	700 - 750				
H-3	1.58E+02	1.12E+02	8.70E+01	5.89E+01	4.70E-02	0	0	0	0	0	1.43E+03
C-14	1.72E-01	4.44E-01	3.45E-01	1.41E-01	1.01E-02	0	0	0	0	0	3.83E+00
Fe-55	6.85E-03	1.15E-02	1.91E-02	4.13E-04	4.56E-04	0	0	0	0	0	2.37E-01
Co-60	1.05E+00	2.90E-01	2.79E-01	2.88E-02	2.10E-02	0	0	0	0	0	3.59E+01
Ni-59	1.67E-03	4.62E-03	4.55E-03	3.41E-04	3.62E-04	0	0	0	0	0	1.24E-01
Ni-63	4.71E-01	8.19E-01	1.19E+00	8.52E-02	9.28E-02	0	0	0	0	0	1.33E+01
Kr-85	0	0	0	0	0	0	0	0	0	0	0
Sr-90	3.72E-01	5.67E-01	9.73E-01	7.16E-02	2.69E-02	0	0	0	0	0	1.86E+01
Y-90	3.72E-01	5.67E-01	9.73E-01	7.16E-02	2.70E-02	0	0	0	0	0	1.86E+01
Zr-93	8.25E-04	1.23E-03	4.47E-03	1.94E-03	9.42E-07	0	0	0	0	0	1.24E-02
Nb-94	5.25E-05	1.46E-04	1.44E-04	1.08E-05	1.14E-05	0	0	0	0	0	3.90E-03
Tc-99	1.46E-04	2.76E-04	3.41E-04	2.08E-05	2.90E-05	0	0	0	0	0	8.85E-03
I-129	3.31E-04	7.08E-04	8.08E-04	6.00E-05	6.56E-05	0	0	0	0	0	2.38E-02
Cs-135	1.30E-04	2.70E-04	3.26E-04	2.04E-05	2.24E-05	0	0	0	0	0	8.84E-03
Cs-137	1.97E+00	4.12E+00	4.80E+00	3.80E-01	3.58E-01	0	0	0	0	0	1.29E+02
Ba-137m	1.87E+00	3.89E+00	4.54E+00	3.59E-01	3.38E-01	0	0	0	0	0	1.22E+02
Pm-147	2.36E-03	2.59E-03	6.23E-03	0	8.70E-05	0	0	0	0	0	3.87E-02
Ti-207	1.88E-05	6.24E-07	1.47E-07	1.26E-08	3.43E-08	0	0	0	0	0	3.42E-05
Ti-208	4.02E-06	1.22E-06	1.11E-02	0	1.72E-06	0	0	0	0	0	3.24E-02
Pb-210	7.09E-02	3.96E-02	8.20E-02	3.84E-15	8.73E-13	0	0	0	0	0	6.24E-01
Pb-211	1.89E-05	6.26E-07	1.47E-07	1.26E-08	3.44E-08	0	0	0	0	0	3.43E-05
Pb-212	1.12E-05	3.41E-06	3.10E-02	0	4.79E-06	0	0	0	0	0	9.01E-02
Pb-214	1.29E-01	7.20E-02	1.49E-01	0	2.52E-12	0	0	0	0	0	1.13E+00
Po-210	6.99E-02	3.90E-02	8.08E-02	3.53E-15	8.44E-13	0	0	0	0	0	6.15E-01
Po-212	0	0	1.98E-02	0	0	0	0	0	0	0	4.96E-02
Po-214	1.29E-01	7.20E-02	1.49E-01	0	0	0	0	0	0	0	1.13E+00
Po-215	1.89E-05	0	0	0	0	0	0	0	0	0	3.28E-05
Po-216	1.12E-05	3.41E-06	3.10E-02	0	4.79E-06	0	0	0	0	0	9.01E-02
Po-218	1.29E-01	7.20E-02	1.49E-01	0	0	0	0	0	0	0	1.13E+00
Rn-219	1.89E-05	6.26E-07	1.47E-07	1.26E-08	3.44E-08	0	0	0	0	0	3.43E-05
Rn-220	1.12E-05	3.41E-06	3.10E-02	0	4.79E-06	0	0	0	0	0	9.01E-02

Table 4A-13. SDA Trench 13 Radionuclide Inventory (Page 4 of 4)

Nuclide	Curies per Trench Interval (feet from North end)										Total
	400 - 449	450 - 499	500 - 549	550 - 599	600 - 649	650 - 699	700 - 750				
Rn-222	1.29E-01	7.20E-02	1.49E-01	2.23E-14	2.52E-12	0	0	0	0	0	1.13E+00
Ra-223	1.89E-05	6.26E-07	1.47E-07	1.26E-08	3.44E-08	0	0	0	0	0	3.43E-05
Ra-224	1.12E-05	3.41E-06	3.10E-02	0	4.79E-06	0	0	0	0	0	9.01E-02
Ra-226	1.29E-01	7.20E-02	1.49E-01	2.23E-14	2.52E-12	0	0	0	0	0	1.13E+00
Ra-228	1.39E-08	4.24E-09	3.17E-02	0	5.97E-09	0	0	0	0	0	9.22E-02
Ac-227	1.91E-05	6.31E-07	1.48E-07	1.27E-08	3.45E-08	0	0	0	0	0	3.45E-05
Ac-228	1.39E-08	4.24E-09	3.17E-02	0	5.97E-09	0	0	0	0	0	9.22E-02
Th-227	1.87E-05	6.19E-07	1.45E-07	1.25E-08	3.40E-08	0	0	0	0	0	3.39E-05
Th-228	1.12E-05	3.41E-06	3.10E-02	0	4.79E-06	0	0	0	0	0	9.01E-02
Th-230	7.81E-04	1.56E-05	2.87E-07	5.98E-12	2.71E-10	0	0	0	0	0	1.34E-03
Th-231	1.12E-01	3.57E-03	5.22E-04	7.50E-05	1.44E-06	0	0	0	0	0	1.97E-01
Th-232	1.44E-08	4.38E-09	3.33E-02	1.27E-22	6.16E-09	0	0	0	0	0	9.67E-02
Th-234	7.82E+00	6.92E-02	1.38E-03	9.91E-06	1.16E-05	0	0	0	0	0	1.32E+01
Pa-231	6.03E-05	1.97E-06	3.81E-07	4.05E-08	5.83E-08	0	0	0	0	0	1.08E-04
Pa-234m	7.82E+00	6.92E-02	1.38E-03	9.91E-06	1.16E-05	0	0	0	0	0	1.32E+01
U-233	2.24E-05	6.82E-06	1.66E-05	4.07E-13	9.60E-06	0	0	0	0	0	9.41E-05
U-234	3.40E+00	6.79E-02	1.25E-03	5.05E-08	5.42E-07	0	0	0	0	0	5.77E+00
U-235	1.12E-01	3.57E-03	5.22E-04	7.50E-05	1.44E-06	0	0	0	0	0	1.97E-01
U-238	7.82E+00	6.92E-02	1.38E-03	9.91E-06	1.16E-05	0	0	0	0	0	1.32E+01
Pu-238	4.13E-03	6.32E-03	8.66E-03	6.21E-04	1.00E-03	0	0	0	0	0	4.20E+00
Pu-239	3.49E-03	4.57E-03	6.57E-03	4.44E-04	9.25E-04	0	0	0	0	0	1.06E+01
Pu-240	7.18E-04	2.25E-04	5.39E-04	6.43E-07	3.07E-04	0	0	0	0	0	3.39E+00
Pu-241	7.32E-02	7.90E-02	1.19E-01	7.21E-03	2.25E-02	0	0	0	0	0	1.29E+02
Am-241	8.98E-03	1.13E-02	1.63E-02	1.14E-03	2.48E-03	0	0	0	0	0	1.09E+01
Cm-242	2.89E-06	8.79E-07	2.14E-06	0	1.24E-06	0	0	0	0	0	1.21E-05
Total	192.63	123.30	101.70	1.74	0.95	0	0	0	0	0	1,981.03

Table 4A-14. SDA Trench 14 Radionuclide Inventory (Page 1 of 4)

Nuclide	Curies per Trench Interval (feet from North end)									
	0 - 49	50 - 99	100 - 149	150 - 199	200 - 249	250 - 299	300 - 349	350 - 399		
H-3	1.52E+02	1.09E+00	1.42E+01	1.56E+02	1.46E+01	5.17E+01	3.75E+00	6.37E+01		
C-14	1.50E+00	2.41E-01	6.31E-01	1.16E+00	9.03E-02	8.93E-01	8.43E-01	1.34E-01		
Fe-55	9.75E-02	2.75E-02	3.94E-01	3.79E-02	2.36E-03	4.66E-03	3.17E-02	1.60E-02		
Co-60	2.01E+00	6.96E-01	9.19E+00	4.77E+00	1.13E-01	2.84E-01	1.35E+00	6.88E-01		
Ni-59	2.14E-01	1.20E-02	1.04E+00	2.52E-02	1.90E-03	3.73E-03	2.29E-02	1.15E-02		
Ni-63	6.44E+00	1.46E+00	2.74E+01	6.51E+00	4.24E-01	9.21E-01	4.96E+00	2.00E+00		
Kr-85	9.61E-03	0	0	0	0	0	0	0		
Sr-90	1.26E+01	8.05E-01	7.28E-01	1.40E+00	7.69E-02	2.50E-01	6.19E-01	1.13E-01		
Y-90	1.26E+01	8.06E-01	7.28E-01	1.40E+00	7.69E-02	2.50E-01	6.20E-01	1.14E-01		
Zr-93	1.17E-02	3.87E-05	8.94E-03	1.10E-06	1.27E-02	5.47E-03	1.94E-07	4.03E-07		
Nb-94	1.67E-04	3.81E-04	7.13E-04	8.00E-04	6.02E-05	1.18E-04	7.25E-04	3.62E-04		
Tc-99	3.90E-04	7.57E-04	1.20E-03	6.25E-03	1.21E-04	2.43E-04	1.34E-03	6.97E-04		
I-129	6.58E-04	2.00E-03	2.05E-03	1.84E-02	3.31E-04	6.98E-04	3.80E-03	1.98E-03		
Cs-135	2.87E-04	7.57E-04	7.69E-04	6.24E-03	1.14E-04	2.38E-04	1.32E-03	6.91E-04		
Cs-137	7.67E+00	1.10E+01	1.15E+01	9.24E+01	1.74E+00	4.04E+00	1.98E+01	1.03E+01		
Ba-137m	7.26E+00	1.04E+01	1.09E+01	8.74E+01	1.65E+00	3.82E+00	1.87E+01	9.76E+00		
Pm-147	7.91E-03	5.26E-03	2.68E-03	3.44E-03	8.07E-05	7.30E-05	1.53E-03	4.35E-05		
Ti-207	2.66E-07	2.10E-07	8.00E-06	2.02E-07	1.03E-05	1.29E-07	1.93E-05	1.11E-07		
Ti-208	2.40E-02	1.42E-01	7.40E-02	2.23E-02	1.60E-06	1.67E-02	1.11E-02	8.34E-05		
Pb-210	1.42E-01	3.40E-01	8.07E-03	1.74E-03	3.37E-03	8.27E-03	2.55E-03	1.81E-03		
Pb-211	2.67E-07	2.11E-07	8.02E-06	2.02E-07	1.03E-05	1.29E-07	1.94E-05	1.11E-07		
Pb-212	6.67E-02	3.97E-01	2.06E-01	6.20E-02	4.44E-06	4.64E-02	3.10E-02	2.32E-04		
Pb-214	2.58E-01	6.17E-01	1.47E-02	3.16E-03	6.13E-03	1.50E-02	4.63E-03	3.32E-03		
Po-210	1.40E-01	3.35E-01	7.95E-03	1.72E-03	3.33E-03	8.15E-03	2.51E-03	1.78E-03		
Po-212	4.27E-02	2.54E-01	1.32E-01	3.97E-02	0	2.97E-02	1.98E-02	0		
Po-214	2.58E-01	6.17E-01	1.47E-02	3.16E-03	6.13E-03	1.50E-02	4.63E-03	3.32E-03		
Po-215	0	0	8.02E-06	0	1.03E-05	0	1.94E-05	0		
Po-216	6.67E-02	3.97E-01	2.06E-01	6.20E-02	4.44E-06	4.64E-02	3.10E-02	2.32E-04		
Po-218	2.58E-01	6.17E-01	1.47E-02	3.16E-03	6.13E-03	1.50E-02	4.63E-03	3.32E-03		
Rn-219	2.67E-07	2.11E-07	8.02E-06	2.02E-07	1.03E-05	1.29E-07	1.94E-05	1.11E-07		
Rn-220	6.67E-02	3.97E-01	2.06E-01	6.20E-02	4.44E-06	4.64E-02	3.10E-02	2.32E-04		

Table 4A-14. SDA Trench 14 Radionuclide Inventory (Page 2 of 4)

Nuclide	Curies per Trench Interval (feet from North end)									
	0 - 49	50 - 99	100 - 149	150 - 199	200 - 249	250 - 299	300 - 349	350 - 399		
Rn-222	2.58E-01	6.17E-01	1.47E-02	3.16E-03	6.13E-03	1.50E-02	4.63E-03	3.32E-03		
Ra-223	2.67E-07	2.11E-07	8.02E-06	2.02E-07	1.03E-05	1.29E-07	1.94E-05	1.11E-07		
Ra-224	6.67E-02	3.97E-01	2.06E-01	6.20E-02	4.44E-06	4.64E-02	3.10E-02	2.32E-04		
Ra-226	2.58E-01	6.17E-01	1.47E-02	3.16E-03	6.13E-03	1.50E-02	4.63E-03	3.32E-03		
Ra-228	6.83E-02	4.06E-01	2.11E-01	6.35E-02	5.54E-09	4.76E-02	3.17E-02	2.36E-04		
Ac-227	2.69E-07	2.12E-07	8.09E-06	2.04E-07	1.04E-05	1.30E-07	1.95E-05	1.12E-07		
Ac-228	6.83E-02	4.06E-01	2.11E-01	6.35E-02	5.54E-09	4.76E-02	3.17E-02	2.36E-04		
Th-227	2.64E-07	2.08E-07	7.94E-06	2.00E-07	1.02E-05	1.28E-07	1.91E-05	1.10E-07		
Th-228	6.67E-02	3.97E-01	2.06E-01	6.20E-02	4.44E-06	4.64E-02	3.10E-02	2.32E-04		
Th-230	3.13E-07	1.84E-06	3.25E-04	3.48E-07	4.23E-04	3.55E-08	8.03E-04	5.16E-08		
Th-231	1.23E-03	1.16E-03	4.70E-02	9.65E-04	6.09E-02	7.47E-04	1.15E-01	5.85E-04		
Th-232	7.16E-02	4.26E-01	2.21E-01	6.66E-02	5.71E-09	4.99E-02	3.33E-02	2.49E-04		
Th-234	2.23E-04	3.06E-03	3.26E+00	6.27E-03	4.25E+00	2.68E-04	8.06E+00	7.67E-04		
Pa-231	7.63E-07	6.50E-07	2.55E-05	5.87E-07	3.29E-05	4.08E-07	6.19E-05	3.36E-07		
Pa-234m	2.23E-04	3.06E-03	3.26E+00	6.27E-03	4.25E+00	2.68E-04	8.06E+00	7.67E-04		
U-233	1.77E-05	4.33E-06	2.81E-05	1.12E-05	8.90E-06	9.27E-07	1.98E-06	6.51E-06		
U-234	1.36E-03	8.00E-03	1.42E+00	1.52E-03	1.84E+00	1.55E-04	3.50E+00	2.25E-04		
U-235	1.23E-03	1.16E-03	4.70E-02	9.65E-04	6.09E-02	7.47E-04	1.15E-01	5.85E-04		
U-238	2.23E-04	3.06E-03	3.26E+00	6.27E-03	4.25E+00	2.68E-04	8.06E+00	7.67E-04		
Pu-238	7.50E-03	1.48E-02	1.45E-02	1.62E-01	3.53E-03	7.13E-03	3.69E-02	1.75E-02		
Pu-239	5.74E-03	1.08E-02	1.05E-02	1.38E-01	2.72E-03	5.19E-03	2.62E-02	1.27E-02		
Pu-240	5.71E-04	1.61E-04	9.14E-04	5.37E-04	2.90E-04	3.70E-05	1.02E-04	1.50E-04		
Pu-241	1.07E-01	1.65E-01	1.86E-01	1.79E+00	5.08E-02	8.35E-02	4.26E-01	2.05E-01		
Am-241	1.59E-02	3.51E-02	6.55E-02	2.77E-01	6.78E-03	1.29E-02	6.35E-02	2.94E-02		
Cm-242	2.28E-06	5.58E-07	3.62E-06	1.44E-06	1.15E-06	1.20E-07	2.55E-07	5.30E-07		
Total	205.10	35.54	90.50	354.23	33.66	62.86	79.57	87.15		

Table 4A-14. SDA Trench 14 Radionuclide Inventory (Page 3 of 4)

Nuclide	Curies per Trench Interval (feet from North end)										Total
	400 - 449	450 - 499	500 - 549	550 - 599	600 - 649	650 - 699	700 - 750				
H-3	9.67E-01	3.48E+02	4.70E+00	1.27E+00	3.67E-03	0	0	0	0	0	8.12E+02
C-14	2.15E-01	1.22E-01	9.05E-01	2.15E-01	6.13E-04	0	0	0	0	0	6.95E+00
Fe-55	5.35E-03	1.84E-02	2.66E-02	2.52E-02	2.37E-05	0	0	0	0	0	6.87E-01
Co-60	2.41E-01	7.59E-01	1.17E+00	1.00E+00	1.03E-03	0	0	0	0	0	2.23E+01
Ni-59	3.71E-03	1.23E-02	1.87E-02	1.63E-02	1.69E-05	0	0	0	0	0	1.38E+00
Ni-63	8.25E-01	2.02E+00	4.37E+00	1.68E+00	4.38E-03	0	0	0	0	0	5.90E+01
Kr-85	0	0	7.01E+01	0	0	0	0	0	0	0	7.01E+01
Sr-90	1.47E-01	1.50E-01	6.96E-01	2.14E-01	5.97E-04	0	0	0	0	0	1.78E+01
Y-90	1.47E-01	1.50E-01	6.97E-01	2.14E-01	5.97E-04	0	0	0	0	0	1.78E+01
Zr-93	7.00E-07	1.56E-04	2.21E-07	0	0	0	0	0	0	0	3.91E-02
Nb-94	1.17E-04	3.88E-04	5.91E-04	5.16E-04	5.35E-07	0	0	0	0	0	4.94E-03
Tc-99	2.24E-04	6.80E-04	3.73E-03	2.03E-03	4.64E-06	0	0	0	0	0	1.77E-02
I-129	6.29E-04	1.88E-03	1.10E-02	5.87E-03	1.37E-05	0	0	0	0	0	4.93E-02
Cs-135	2.16E-04	6.61E-04	3.73E-03	2.04E-03	4.64E-06	0	0	0	0	0	1.71E-02
Cs-137	3.36E+00	9.94E+00	5.61E+01	3.05E+01	6.96E-02	0	0	0	0	0	2.58E+02
Ba-137m	3.18E+00	9.40E+00	5.31E+01	2.88E+01	6.58E-02	0	0	0	0	0	2.45E+02
Pm-147	7.65E-02	2.67E-04	2.39E-05	0	0	0	0	0	0	0	9.78E-02
Ti-207	3.98E-08	1.06E-05	1.97E-06	1.49E-08	4.30E-11	0	0	0	0	0	5.11E-05
Ti-208	1.29E-06	5.41E-05	1.80E-02	0	0	0	0	0	0	0	3.09E-01
Pb-210	4.95E-04	6.97E-03	1.61E+00	2.56E-13	6.78E-16	0	0	0	0	0	2.13E+00
Pb-211	3.99E-08	1.06E-05	1.97E-06	1.50E-08	4.31E-11	0	0	0	0	0	5.12E-05
Pb-212	3.58E-06	1.51E-04	5.02E-02	0	0	0	0	0	0	0	8.59E-01
Pb-214	9.13E-04	1.29E-02	2.98E+00	1.52E-12	0	0	0	0	0	0	3.92E+00
Bi-210	4.94E-04	6.96E-03	1.61E+00	2.55E-13	0	0	0	0	0	0	2.13E+00
Bi-211	3.99E-08	1.06E-05	1.97E-06	1.50E-08	4.31E-11	0	0	0	0	0	5.12E-05
Bi-212	3.58E-06	1.51E-04	5.02E-02	0	0	0	0	0	0	0	8.59E-01
Bi-214	9.13E-04	1.29E-02	2.98E+00	0	0	0	0	0	0	0	3.92E+00
Po-210	4.87E-04	6.86E-03	1.59E+00	2.35E-13	6.23E-16	0	0	0	0	0	2.10E+00
Po-212	0	0	3.21E-02	0	0	0	0	0	0	0	5.50E-01
Po-214	9.13E-04	1.29E-02	2.98E+00	0	0	0	0	0	0	0	3.91E+00
Po-215	0	1.06E-05	1.97E-06	0	0	0	0	0	0	0	5.02E-05
Po-216	3.58E-06	1.51E-04	5.02E-02	0	0	0	0	0	0	0	8.59E-01
Po-218	9.13E-04	1.29E-02	2.98E+00	0	0	0	0	0	0	0	3.92E+00
Rn-219	3.99E-08	1.06E-05	1.97E-06	1.50E-08	0	0	0	0	0	0	5.12E-05
Rn-220	3.58E-06	1.51E-04	5.02E-02	0	0	0	0	0	0	0	8.59E-01

Table 4A-14. SDA Trench 14 Radionuclide Inventory (Page 4 of 4)

Nuclide	Curies per Trench Interval (feet from North end)										Total
	400 - 449	450 - 499	500 - 549	550 - 599	600 - 649	650 - 699	700 - 750				
Rn-222	9.13E-04	1.29E-02	2.98E+00	1.52E-12	0	0	0	0	0	0	3.92E+00
Ra-223	3.99E-08	1.06E-05	1.97E-06	1.50E-08	4.31E-11	0	0	0	0	0	5.12E-05
Ra-224	3.58E-06	1.51E-04	5.02E-02	0	0	0	0	0	0	0	8.59E-01
Ra-226	9.13E-04	1.29E-02	2.98E+00	1.52E-12	4.03E-15	0	0	0	0	0	3.92E+00
Ra-228	4.43E-09	1.42E-04	5.15E-02	0	0	0	0	0	0	0	8.80E-01
Ac-227	4.01E-08	1.07E-05	1.99E-06	1.51E-08	4.35E-11	0	0	0	0	0	5.16E-05
Ac-228	4.43E-09	1.42E-04	5.15E-02	0	0	0	0	0	0	0	8.80E-01
Th-227	3.94E-08	1.05E-05	1.95E-06	1.48E-08	4.26E-11	0	0	0	0	0	5.07E-05
Th-228	3.58E-06	1.51E-04	5.02E-02	0	0	0	0	0	0	0	8.59E-01
Th-230	2.51E-10	4.44E-04	8.17E-05	4.18E-10	1.11E-12	0	0	0	0	0	2.08E-03
Th-231	9.17E-05	6.50E-02	1.21E-02	9.27E-05	2.67E-07	0	0	0	0	0	3.05E-01
Th-232	4.58E-09	1.49E-04	5.42E-02	9.82E-21	2.47E-23	0	0	0	0	0	9.23E-01
Th-234	9.28E-05	4.56E+00	8.41E-01	7.27E-04	2.09E-06	0	0	0	0	0	2.10E+01
Pa-231	9.10E-08	3.44E-05	6.41E-06	4.88E-08	1.40E-10	0	0	0	0	0	1.64E-04
Pa-234m	9.28E-05	4.56E+00	8.41E-01	7.27E-04	2.09E-06	0	0	0	0	0	2.10E+01
U-233	7.13E-06	2.52E-05	2.25E-06	2.57E-11	7.02E-14	0	0	0	0	0	1.14E-04
U-234	8.51E-07	1.98E+00	3.64E-01	3.61E-06	9.56E-09	0	0	0	0	0	9.12E+00
U-235	9.17E-05	6.50E-02	1.21E-02	9.27E-05	2.67E-07	0	0	0	0	0	3.05E-01
U-238	9.28E-05	4.56E+00	8.41E-01	7.27E-04	2.09E-06	0	0	0	0	0	2.10E+01
Pu-238	6.43E-03	1.70E-02	9.70E-02	4.56E-02	1.21E-04	0	0	0	0	0	4.30E-01
Pu-239	4.72E-03	1.24E-02	8.16E-02	3.78E-02	1.03E-04	0	0	0	0	0	3.49E-01
Pu-240	2.34E-04	8.22E-04	1.78E-04	5.23E-05	1.32E-07	0	0	0	0	0	4.05E-03
Pu-241	8.42E-02	2.25E-01	1.10E+00	5.01E-01	1.36E-03	0	0	0	0	0	4.92E+00
Am-241	1.15E-02	3.00E-02	1.64E-01	7.49E-02	2.04E-04	0	0	0	0	0	7.87E-01
Cm-242	9.22E-07	3.26E-06	2.91E-07	0	0	0	0	0	0	0	1.44E-05
Total	9.28	386.75	219.56	64.61	0.15	0	0	0	0	0	1,628.95

SECTION 5

THREAT ANALYSIS

This study evaluates the risk from continued operation of the SDA for the next 30 years with its current physical and administrative controls. During this period, a variety of conditions may occur that have potential impacts on that risk. These conditions are broadly characterized as "threats" to the SDA. Some threats may cause a direct release of radioactive materials from the waste trenches. Some conditions may alter the site in ways that increase its vulnerability to other threats. Potential conditions that may affect the site can be grouped into two general categories.

- **Disruptive Events.** These are unexpected events that may cause an immediate change to the site. They are typically characterized by an event occurrence frequency and by directly measurable immediate consequences. Examples are severe storms, tornadoes, earthquakes, fires, and airplane crashes.
- **Nominal Events and Processes.** These are expected events and processes that evolve continuously over the life of the facility. They are typically characterized by a rate, which may be constant or changing over time. The potential consequences from these processes depend on the duration of the exposure period. Examples are groundwater flows, slope subsidence, and the aging of engineered and natural systems.

The scope of potential threats considered in this study includes a broad variety of natural phenomena and processes, and human-caused events. The study does not quantify the risk from intentional acts of destruction, war, terrorism, or sabotage. In principle, the QRA methods and modeling framework could be used to evaluate these types of threats. However, quantitative assessment of the risk would require substantial specialized input from outside security organizations and experts to define the specific types of threat scenarios that may evolve from deliberately destructive acts and to derive realistic estimates for their potential frequencies. Brief consideration was given to selecting a few "evident" intentional threats to demonstrate how these acts are treated within the overall risk assessment process. However, that option was discarded because it is fundamentally inconsistent with the systematic, comprehensive nature of the risk assessment process. The QRA team was concerned that these partial analyses might inadvertently imply that a "complete" assessment of deliberately aggressive acts had been performed, or that the selected acts would receive inappropriate attention as the "most important" potential contributors. Therefore, the team decided that the most appropriate decision was to exclude rigorous quantification of the risk from this class of threats from the current study. Simplified analyses were performed to provide an understanding of the potential risks from these types of threats, without a comprehensive assessment of the threat frequencies, uncertainties, or full integration into the overall QRA results (see Section 15.2).

Section 5.1 describes the process that was used to identify all other potential threats to the SDA and to determine which specific threats are evaluated in this study. Sections 5.2 through 5.8 summarize the analyses that were performed to quantify the disruptive event frequencies.

5.1 SCREENING OF SDA THREATS

The scope of potential threats that were considered in this study is summarized in Table 5.1-1. This list was derived from a variety of sources. References and guidance documents for commercial nuclear power plant risk assessments contain comprehensive compilations of potential events that may affect a generic site (e.g., Reference 5.1-1). Additional specific threats for the SDA were derived from reviews of the available West Valley site studies and safety analysis reports (e.g., References 5.1-2 and 5.1-3).

The following sections document the bases for eliminating specific threats from explicit quantification in this study, and identify the threats that are retained for more detailed analysis. Table 5.1-2 lists the threats that are quantified in the risk assessment models.

5.1.1 Disruptive Events

5.1.1.1 Aircraft Crashes

The frequencies and consequences from crashes of commercial, military, and general aviation aircraft are included in the SDA risk assessment. It is assumed that a commercial or military aircraft crash will cause sufficient damage to penetrate the SDA trench caps to the depth of the waste materials. General aviation aircraft do not have sufficient mass or energy to fully penetrate the compacted soil cap to that depth. However, larger aircraft (e.g., private and corporate jets) may disrupt a few feet of the trench caps, depending on the mass of the aircraft and engines, impact angle, and fuel loading. Therefore, it is conservatively assumed that the physical damage and fire from any aircraft crash will destroy a large area of the geomembrane covers and disrupt the trench clay caps.

5.1.1.2 Avalanches

The SDA site is not located near any mountainous areas or large steep slopes that are prone to avalanches. This potential threat was screened from further consideration.

5.1.1.3 Biological Events

The SDA site and the geomembrane covers are not susceptible to disruptive damage from biological events (e.g., algae blooms, sudden fish kills, bacteriological attacks, rapid intrusion of aquatic or land organisms, etc.).

Potential impacts from burrowing animals that may disrupt the site drainage and water intrusion control systems are limited by the routine site monitoring and maintenance programs. These programs will remain in place throughout the 30-year period of this study. Therefore, the study accounts for these potential impacts in its evaluation of the effectiveness of the site physical and administrative controls.

5.1.1.4 Drought

Prolonged drought conditions will affect water flow rates throughout the interconnected drainage basin, including Buttermilk Creek. These flows affect dilution, deposition, and potential doses from radioactive materials that may be released from the SDA. Stream flow

variations are included in the risk analysis transport models. However, drought is not a direct cause or contributor to possible releases from the SDA trenches. This potential threat was screened from further consideration.

5.1.1.5 Erosion

The SDA site is not susceptible to coastal, lake shore, or river bank erosion.

Erosive forces that may alter the topography of the South Plateau over hundreds or thousands of years were judged to be an insignificant contributor to potential releases from the SDA trenches during the 30-year time frame of this study, and they were screened from further consideration.

The impacts from rapid erosion of the slopes and gullies at the SDA periphery adjacent to Erdman Brook and Frank's Creek are included in the risk assessment. Rapid erosive conditions that are exacerbated by severe rainfalls, surface runoff, and flooding are categorized as disruptive events for this study.

5.1.1.6 Excavation of Stream Sediments

The scope of proposed West Valley site remediation alternatives includes excavation of contaminated sediments from the beds of Erdman Brook and Frank's Creek, between the Lagoon 3 outfall and the confluence of Frank's Creek and Quarry Creek (Reference 5.1-2). It is estimated that an average of approximately 1 foot of the stream bed material would be removed. Stream flows in Erdman Brook and Frank's Creek would be temporarily diverted to bypass the excavation sections.

If they are implemented, these activities would alter the local hydrology in the Erdman Brook, Frank's Creek, and Buttermilk Creek drainage systems. It is assumed for this study that any engineered remediation activities would carefully consider potential impacts on the adjoining areas of the South Plateau. In particular, it is assumed that physical barriers would be installed and monitoring would be performed to ensure that these activities do not exacerbate erosion of the slopes and gullies at the south side of Erdman Brook, adjacent to the SDA. If they are properly implemented, it is possible that these measures could substantially reduce the likelihood for rapid erosion of the Erdman Brook slopes. However, without any information about the scope or schedule for these activities, the analyses for this study assume that the slopes will remain undisturbed and in their current geometry.

Changes to the flows in Erdman Brook and Frank's Creek would affect this study's analyses and models for the transport of released radioactive liquids and solids from the SDA to the primary receptors. However, without any specific information about how the stream flows may be altered or when the excavation work may be performed, it is not possible to estimate the potential impacts on the overall risk results. Therefore, until a final decision is made regarding the extent of site remediation activities and their schedule, this study assumes that the Erdman Brook and Frank's Creek drainage basins will remain undisturbed by excavation work.

5.1.1.7 Explosions

The only source of potentially damaging explosions is the West Valley site natural gas supply line that is routed around the northeast boundary of the SDA. That potential threat is discussed more specifically in Section 5.1.1.24, Pipeline Accidents.

5.1.1.8 Extraterrestrial Impacts

The potential risk from impacts by falling space debris (e.g., failed satellites, etc.) is bounded by the higher frequencies and similar consequences from aircraft crashes, which are included in the SDA risk assessment.

Preliminary analyses concluded that the impact frequencies for large meteorites and asteroids are sufficiently small to justify screening those threats from further consideration. However, that conclusion does not apply to meteorites with diameters of less than approximately 1 meter. Although the frequency of these impacts is very small in an absolute sense, it is comparable to the frequencies of other threats that are evaluated in this study. Therefore, the impact frequencies and consequences from meteorites with diameters less than 1 meter are included in the SDA risk assessment.

5.1.1.9 Extreme Temperatures

The XR-5 geomembrane material that covers most of the SDA (Trenches 1 – 12) has a minimum service temperature rating of -30°F. A minimum temperature rating was not readily available for the Very Low Density Polyethylene material that covers Trenches 13 and 14. However, industry literature indicates that it may be susceptible to embrittlement at temperatures below -5°F (Reference 5.1-4).

High temperatures increase oxidation of the stabilizers in the geomembrane materials, and rapid temperature changes induce thermal stresses.

Potential impacts from thermal stresses on the geomembrane covers are addressed by the routine site monitoring and maintenance programs. These programs will remain in place throughout the 30-year period of this study. Therefore, the study accounts for these potential impacts in its evaluation of the effectiveness of the site physical and administrative controls.

The impacts from freeze / thaw cycles and soil desiccation are included in the study through their effects on soil porosity in the groundwater transport analyses and as a contribution to potential slope instability.

5.1.1.10 Fires

Three radioactive liquid storage tanks are located inside two small buildings at the west side of the SDA. Two of the tanks, located in the Frac Tank Building, are currently empty and have never been used. One tank, located in the T1 Tank Building, currently contains approximately 8,000 gallons of untreated radioactive leachate that was pumped from Trench 14 in 1991. NYSERDA has indicated that this tank will be drained by 2010, and the liquid will be removed for offsite treatment and disposal. There are no current plans to use this tank for additional liquid waste storage. Based on these near-term commitments and plans, this study does not evaluate potential releases from the liquid waste storage tanks. Therefore, potential fire ignition

and damage to equipment inside these buildings ("internal fires") were screened from further consideration. Fires that may originate within these buildings and propagate to the SDA covered area are considered as possible contributors to grass fires that may begin anywhere in the area surrounding the site.

Flammability ratings and ignition temperatures were not readily available for the XR-5 geomembrane material that covers most of the SDA (Trenches 1 – 12) or the VLDPE material that covers Trenches 13 and 14. It is understood that these materials have some degree of fire resistance and that XR-5 is often used to line secondary confinement basins for petroleum storage tanks. However, it is also understood that the material will ignite if exposed to an open flame for an indeterminate period of time. It is assumed for this study that the geomembranes are susceptible to ignition and damage if a wildfire (e.g., forest fire, grass fire, etc.) affects the SDA site. Therefore, this potential threat is included in the SDA risk assessment.

5.1.1.11 Flooding Events

As noted in Section 5.1.1.10, the equipment and tanks inside the Frac Tank Building and the T1 Tank Building are excluded from this study, because all radioactive liquid will be removed by 2010. Therefore, potential flooding damage to equipment inside these buildings ("internal floods") was screened from further consideration. The relatively small volume of liquid in these tanks and piping systems is not a significant threat for flooding damage to the geomembranes or the SDA trenches, if it were released from the buildings.

The impacts from extreme precipitation, snow melt, and other severe weather conditions are included in the SDA risk assessment.

The SDA is an inland site that is not susceptible to flooding from seiches, storm surges, or tsunamis. These potential flooding threats were screened from further consideration.

The West Valley site water supply reservoirs are located approximately 3/4-mile south of the SDA. Both reservoirs have earthen dams. The South Reservoir dam is approximately 75 feet high, and the North Reservoir dam is approximately 50 feet high (Reference 5.1-2). The reservoirs are separated from the SDA by intervening higher elevation land. Failures of either dam would release water into the relatively steep tributary streams that drain directly into Buttermilk Creek. Therefore, failures of these dams will not cause flooding of the SDA site, and they were screened from further consideration.

Site Water Supply Pipe

The West Valley site water supply pump house is located at the North Reservoir. The pump house contains two 400-gpm pumps. The water is pumped to a 475,000 gallon storage tank at the North Plateau through an 8-inch underground pipe. The pipe is approximately 5,900 feet long (Reference 5.1-3). The pipe is routed along the right-of-way for the site railroad spur, approximately 750 feet west and slightly up-slope from the SDA.

The storage tank is filled from the top, and it contains an anti-siphon air break that prevents reverse flow into the supply pipe. Operation of the reservoir pump is controlled automatically by level in the tank. Low pressure in the line from the reservoir to the tank is alarmed in the site control room. The control room is manned continuously. Personnel locally check the reservoirs and the pump house at least once per day (Reference 5.1-5).

Water may flow into the SDA area if the following conditions occur.

- A large break occurs in the 1,200-foot section of the pipe directly west of the SDA, between the upper reaches of Frank's Creek and Erdman Brook, **and**
- The North Reservoir pump continues to run for an extended period of time

Surface flows do not have a significant potential to damage the geomembrane covers if the site drainage systems are clear and the geomembrane anchor trenches are sealed. These design features are included in the routine site monitoring and maintenance programs. The existing slurry wall along the west side of Trench 14 should deter subsurface inflow to the SDA South Disposal Area through the weathered till soil layer. Slurry walls are currently being installed along the west and south sides of the NDA. Those walls will essentially also provide barriers to subsurface flows into the SDA North Disposal Area.

If the pipe fails, the event will not have a significant impact on SDA risk unless the volume of released water is sufficient to fill at least one of the waste trenches. Trench 14 and Trench 5 are most vulnerable to this threat. Considering their contained volumes of soil and waste materials and their current leachate levels, approximately 388,000 gallons of water are required to fill Trench 5, and 433,000 gallons of water are required to fill Trench 14. Thus, in the most limiting case, if all the released water were delivered immediately to Trench 5, the trench would fill completely if the 400-gpm supply pump ran continuously for approximately 16 hours after the pipe break occurred. Of course, much more time would be available to discover and rectify the problem after an actual pipe failure, because the flow will not be channeled directly to Trench 5, and the intervening slurry walls should divert a substantial amount of the water.

Failures of the water supply pipe may occur "randomly", or the pipe may fail during a seismic event. It is certainly possible that severe seismic events may incapacitate the personnel who are responsible for the water supply system, or substantially delay their effective response to this particular failure. However, earthquake experience has shown that electric power supplies are typically more vulnerable to seismic damage than underground piping systems or engineered structures. After an earthquake that is severe enough to fail the pipe and disorient or incapacitate site personnel, it is very likely that power will not be available for the reservoir pumps. Thus, the only seismic events of concern are those that may fail the pipe, but not disrupt the pump power supplies. These impacts are typical of relatively localized moderate earthquakes that have only temporary effects on human performance. Therefore, it is assumed that the site personnel will be able to turn off the pumps if the earthquake does not directly damage their power supplies.

In summary, potential failures of the site water supply pipe are judged to be an insignificant threat for severe flooding at the SDA. "Random" pipe failure rates are relatively low, and seismic events occur very infrequently. The pipe failure must occur in the 1,200-foot section directly west of the SDA. Water released from any other location will drain away from the SDA into Frank's Creek or Erdman Brook. If the failure causes an eruption of water above the ground, the surface flow will not have a significant impact on the SDA, and it is clearly visible to any personnel traversing the area. If the water release remains below grade, with no disruption of the surface, the most limiting conceivable conditions (certainly not realistic) provide a minimum 16-hour time window for site personnel to recognize the fact that a pipe break has occurred and stop the reservoir pump. The low pressure alarm should alert control room personnel to the problem immediately after the break occurs. It is extremely unlikely that

personnel will not investigate the cause for the alarm. The 16-hour time window provides an opportunity for at least two shifts of control room personnel to identify the condition and rectify the problem. If the low pressure alarm is inoperable when the pipe failure occurs, additional opportunities to identify the problem are afforded by the local inspections at the pump house (abnormal continuous pump operation) and observations of stable or decreasing level in the storage tank without any effect from the running pump. Based on these considerations, it was concluded that failures of the site water supply pipe are an insignificant contribution to the SDA risk, and they were screened from further consideration.

5.1.1.12 Fog

None of the SDA engineered features or barriers are susceptible to damage from prolonged exposure to heavy fog or fog-borne contaminants. This potential threat was screened from further consideration.

5.1.1.13 Frost

None of the SDA engineered features or barriers are susceptible to damage from prolonged exposure to frost. The impacts from freeze / thaw cycles are included in the study through their effects on soil porosity in the groundwater transport analyses and as a contribution to potential slope instability. This potential threat was screened from further consideration.

5.1.1.14 High Tides

The SDA is an inland site that is not susceptible to any tidal influences. This potential threat was screened from further consideration.

5.1.1.15 High Wind Events

The frequencies and consequences from high winds, wind gusts, and tornadoes are included in the SDA risk assessment. The analyses evaluate potential wind damage to the geomembrane covers and the impacts from precipitation during severe storms.

5.1.1.16 Hurricanes

The SDA is an inland site that is not directly susceptible to hurricane damage. Historical records show that a few hurricanes on very rare East Coast tracks have caused high winds and large rainfalls as far inland as east-central New York State and south-central Pennsylvania. These impacts are included in the SDA risk assessment through the analyses of severe storm events in the surrounding region. Therefore, additional impacts from this potential threat were screened from further consideration.

5.1.1.17 Ice Cover

Standpipes in the drainage detention basins at the east side of Trenches 1 and 2 and at the northeast corner of Trench 2 were previously damaged by snow and ice sliding off the geomembrane covers. Ice dams were installed to protect these standpipes, and no further damage has occurred. These design features are included in the routine site monitoring and maintenance programs. These programs will remain in place throughout the 30-year period of

this study. Therefore, the study accounts for these potential impacts in its evaluation of the effectiveness of the site physical and administrative controls.

The impacts from freeze / thaw cycles are included in the study through their effects on soil porosity in the groundwater transport analyses and as a contribution to potential slope instability.

5.1.1.18 Landslides

The impacts from landslides that affect the slopes at the north edge of the SDA adjacent to Erdman Brook and the east side of the SDA adjacent to Frank's Creek are included in the risk assessment. The study evaluates the frequencies and consequences from slope failures that may be caused by seismic events. It also evaluates other causes for slope failures due to evolving physical processes at the site, such as freeze / thaw cycles, soil conditions, natural cover, etc.

5.1.1.19 Lightning

The SDA is a very low profile, flat plain site with no significant focal points for lightning strikes. Rare ground strikes may cause localized damage to the geomembrane covers. However, a lightning strike will not disrupt the trench caps sufficiently to expose any of the waste materials.

Potential impacts from lightning strikes that may damage the geomembranes are limited by the routine site monitoring and maintenance programs. These programs will remain in place throughout the 30-year period of this study. Therefore, the study accounts for these potential impacts in its evaluation of the effectiveness of the site physical and administrative controls.

5.1.1.20 Loss of External Power Supplies

None of the SDA engineered features or barriers depend on AC or DC electric power. This potential threat was screened from further consideration.

5.1.1.21 Low Lake or River Water Level

The SDA is an inland site, and none of the engineered features or barriers depends on cooling water. In principle, low levels in the interconnected drainage basin, including Lake Erie, may affect water flow rates through Buttermilk Creek. These flows affect dilution, deposition, and potential doses from radioactive materials that may be released from the SDA. Stream flow variations are included in the risk analysis transport models. However, low levels in the surrounding creeks and Lake Erie are not a direct cause or contributor to possible releases from the SDA trenches. This potential threat was screened from further consideration.

5.1.1.22 Nearby Facility Accidents

The nearest offsite industrial facility is located approximately 2.5 miles from the West Valley site. Industry within a 5-mile radius of the site is generally classified as commercial or light-industrial. Surveys documented in the most recent revision of the WVDP Safety Analysis Report did not identify any nearby industrial, chemical, or military facilities that contain significant quantities of hazardous materials that could affect any West Valley equipment or personnel operations (Reference 5.1-3).

It is not possible to conclusively predict how commercial development might change in the area surrounding the site during the next 30 years. However, the site is located in a relatively remote rural area with only limited access roads. Based on the current land use patterns, it is very likely that any substantial increases in industrial development will occur near Springville and along the Route 219 corridor, approximately 2.5 miles west of the site. That corridor is separated from the site by intervening hills and forested land. It is also likely that near-term development will remain focused on small businesses and light industry, due to the limited local infrastructure. Therefore, this potential threat was screened from further consideration.

In the context of the SDA risk assessment, the West Valley site facilities on the North Plateau are also considered to be a "nearby industrial facility". The WVDP Safety Analysis Report (Reference 5.1-3) does not identify any routine operating conditions or accidents that may directly cause a release from the SDA trenches or cause damage to the geomembranes and engineered drainage systems.

The scope of the proposed WVDP decommissioning and remediation alternatives includes substantial work on the North Plateau (Reference 5.1-2). Details of the specific activities to be performed and their schedules are not yet available. It is assumed for this study that any planned decommissioning activities would carefully consider potential impacts on the adjoining areas of the South Plateau. In particular, it is assumed that physical and administrative controls will be implemented to ensure that these activities do not introduce significant new hazards that may affect the slopes adjacent to the South Plateau, or cause damage to the SDA geomembranes and drainage systems. Without any further information about the final scope or schedule for these activities, the analyses for this study assume that they will have an insignificant impact on the SDA.

Potential SDA impacts from forest fires that may be ignited by offsite or onsite industrial accidents are discussed more specifically in Section 5.1.1.10, Fires.

5.1.1.23 NRC-Licensed Facility Decommissioning Activities

A variety of proposed decommissioning and remediation alternatives remain under consideration for the main portion of the West Valley site (Reference 5.1-2). The specific types and extent of the activities to be conducted during the next 30 years depend on the final selected option. However, with the exceptions of streambed remediation and possible activities at the NDA, almost all of this work will be performed on the North Plateau portion of the site.

It is assumed for this study that any engineered remediation activities would carefully consider potential impacts on adjoining areas of the South Plateau. In particular, it is assumed that engineered systems would be installed and monitoring would be performed to ensure that these activities do not exacerbate surface runoff or subsurface water flows into the SDA, or erosion of the slopes and gullies at the south side of Erdman Brook, adjacent to the SDA. If they are properly implemented, it is possible that these measures could further reduce the likelihood for water intrusion into the SDA trenches or rapid erosion of the Erdman Brook slopes. (For example, current work to install slurry walls at the NDA may also reduce subsurface water flows into the SDA North Disposal Area.) However, without any information about the scope or schedule for these activities, the analyses for this study assume that the SDA geohydrology and the adjoining slope geometries will be neither positively nor adversely impacted by decommissioning work in other areas of the site.

5.1.1.24 Pipeline Accidents

The West Valley site natural gas supply pipe is routed near the northeast corner of the SDA. The pipe originally crossed the SDA area within the site fence. However, it was re-routed when the North Disposal Area geomembranes were installed in 1995, to facilitate construction of the detention basin and drainage systems at the northeast corner of Trench 2. The original pipe enters the West Valley site property from the east, crosses Frank's Creek, and is routed to the top of the slope, outside the east fence of the SDA. The original pipe was cut at that location, and a new pipe section was routed around the northeast corner of the SDA fence. The new pipe section reconnects to the original pipe near Erdman Brook. Based on discussions with the NYSERDA engineers, it is understood that the original pipe is steel, and the new pipe section is polyvinylchloride (PVC). The pipe diameter is 6 inches, and the nominal gas supply pressure is 60 psig. The distance from the pipe to the nearest edge of the geomembrane is approximately 25 feet (Reference 5.1-6).

There has been historical leakage from the gas pipe, before and after installation of the new section around the SDA. The potential impacts from fires or explosions that involve the gas line will not disrupt the SDA trench walls or caps sufficiently to cause a direct release of radioactive materials. However, fires may ignite the geomembrane covers. Therefore, this potential threat is included in the SDA risk assessment.

5.1.1.25 River Diversion

The SDA site is not located near a major river. In principle, significant changes to the flow channels in Frank's Creek and Buttermilk Creek may affect water flow rates through the drainage basin. These flows affect dilution, deposition, and potential doses from radioactive materials that may be released from the SDA. Stream flow variations are included in the risk analysis transport models. Substantial changes to the configuration of Frank's Creek may also affect the likelihood of slope failures and erosion at the east side of the SDA. However, considering the flow gradients and topography in the upper sections of Frank's Creek, before its confluence with Erdman Brook, large changes in the channel geometry over this section of the streambed are very unlikely during the next 30 years. Therefore, this potential threat was screened from further consideration.

Potential impacts from temporary diversions of flows in Erdman Brook and Frank's Creek during streambed remediation activities are discussed more specifically in Section 5.1.1.6, Excavation of Stream Sediments.

5.1.1.26 Seismic Events

The frequencies and consequences from seismic events are included in the SDA risk assessment. The analyses evaluate the direct impacts from seismic-induced failures of the slopes at the north end of the SDA, adjacent to Erdman Brook, and at the east side of the SDA, adjacent to Frank's Creek.

Seismic events may damage the West Valley site natural gas supply pipe. There are no ignition sources near the gas line in the vicinity of the SDA. The closest potential ignition sources are located at the main West Valley site facilities on the North Plateau. Therefore, the likelihood of a seismic-induced fire that may impact the SDA is very small, compared with other

possible causes for gas pipeline fires during normal site operating conditions. This potential threat was screened from further consideration.

Seismic events may damage the West Valley site water supply pipe. The potential threat from seismic-induced flooding of the SDA is discussed more specifically in Section 5.1.1.11, Flooding Events.

5.1.1.27 Severe Storms

The impacts from extreme precipitation, snow melt, and other severe weather conditions are included in the SDA risk assessment.

The geomembranes are not susceptible to significant structural damage by hail. Small tears or punctures may occur near penetration boots where the membrane is not flat. These impacts are limited by the routine site monitoring and maintenance programs. These programs will remain in place throughout the 30-year period of this study. Therefore, the study accounts for these potential impacts in its evaluation of the effectiveness of the site physical and administrative controls.

Dust storms and sand storms are not significant threats in this region of western New York State.

5.1.1.28 Sinkholes

The SDA site and its underlying substrata are not susceptible to the formation of large sinkholes. This potential threat was screened from further consideration.

5.1.1.29 Site Intrusions

The SDA risk assessment is based on the assumption that the current site physical and administrative controls will remain in place for the 30-year period of this study. Therefore, potential threats from direct intrusions into the SDA site area were screened from further consideration.

The risk assessment accounts for potential doses to recreational users (e.g., hikers, hunters, etc.) along Buttermilk Creek and the lower sections of Frank's Creek, including areas that are within the West Valley site property boundaries.

5.1.1.30 Toxic Gas Releases

The SDA site is normally unmanned. Transient incursions of toxic gases will not damage any equipment or incapacitate any personnel whose performance is required to maintain functional integrity of the SDA barriers. The nearest offsite industrial facility is located approximately 2.5 miles from the West Valley site. Potential releases of toxic gases from other facilities on the West Valley site property have no functional impact on the SDA, with the possible exception of adverse health effects for personnel who perform routine security patrols at the site. This potential threat was screened from further consideration.

5.1.1.31 Transportation Accidents

The Buffalo and Pittsburgh Railroad traverses the Buttermilk Creek valley. In the area nearest the West Valley site, the right-of-way is routed along the east side of the creek. A rail spur crosses the creek to provide access for waste shipments from the WVDP. The section of the main rail line from the junction of the spur north to Buffalo is currently abandoned. The main tracks are located approximately 1,700 feet from the SDA at their closest point. The rail spur passes approximately 700 feet from the SDA. In addition to the sheltering afforded by the steep west bank of Buttermilk Creek, there is a low intervening elevation between the west bank of Buttermilk Creek and the eastern drainage slopes for Frank's Creek. Due to the location of the tracks in the Buttermilk Creek valley and the intervening topography, rail accidents are not a significant threat to the SDA, and they were screened from further consideration.

Rock Springs Road is a two-lane rural road with minimal commercial traffic. Most truck traffic on this road is destined for the West Valley site. New York State Route 240 (also designated Cattaraugus County Route 32) is located slightly more than 1 mile northeast of the SDA at its closest point. Route 240 is separated from the site by the Buttermilk Creek valley. U.S. Route 219 is located approximately 2.5 miles west of the SDA. Work is currently in progress to substantially improve Route 219 south of Springville, including straightening, expansion to a four-lane divided highway, and construction of a new bridge over Cattaraugus Creek, near the junction with Schwartz Road. The current sections of Route 219 south of Springville will revert to county road status when the project is finished. It is likely that this expansion will result in increased commercial use of Route 219 as a corridor between Interstate 86 to the south and the greater Buffalo area and Canada to the north. Route 219 is separated from the site by intervening hills and forested land. Due to the locations of U.S. Route 219 and State Route 240, and the intervening topography, highway accidents are not a significant threat to the SDA, and they were screened from further consideration.

The SDA site is not located near any navigable waterways that are used for commercial shipping. Therefore, shipping accidents were screened from further consideration.

Potential SDA impacts from forest fires that may be ignited by railroad or highway accidents are discussed more specifically in Section 5.1.1.10, Fires.

5.1.1.32 Volcanic Activity

The SDA site is not located in a region that is prone to volcanic activity. This potential threat was screened from further consideration.

5.1.2 Nominal Events and Processes

5.1.2.1 Corrosion / Deterioration / Decomposition

The physical status and chemical composition of the geomembranes are inspected during the routine site monitoring and maintenance programs. These programs will remain in place throughout the 30-year period of this study. Therefore, the study accounts for potential geomembrane deterioration in its evaluation of the effectiveness of the site physical and administrative controls.

According to current test results, it is likely that the VLDPE material that covers Trenches 13 and 14 will need replacement in 2010. The observed aging rate for the XR-5 material that covers all other trenches is somewhat slower, but it is anticipated that its replacement may be required in approximately 2015 (Reference 5.1-7). Potential Impacts from these geomembrane replacement projects are included in the SDA risk assessment.

The SDA risk assessment includes a characterization of the physical status, chemical properties, and radionuclide composition of the waste materials at the time of their release into the environment. To the extent possible, this characterization accounts for the effects from decomposition of packaging and waste materials, corrosion of storage drums and other metal containers, and other aging-related effects over the period from initial burial until the time of release.

5.1.2.2 Groundwater Intrusion

Potential impacts from groundwater flows into the waste trenches and radioactive material releases through groundwater pathways are included in the SDA risk assessment. The analyses of groundwater release mechanisms and pathways account for potential flows through the ULT and WLT layers, the available site experience before and after installation of the geomembranes, and evolving site conditions over the subsequent 30-year period of this study.

5.1.2.3 Nuclear Criticality

An assessment of the potential for nuclear criticality at the NDA and SDA was performed in 1998 (Reference 5.1-8). The study examined the inventories and spatial distribution of fissile radionuclides U-233, U-235, and Pu-239 at each facility. The analyses evaluated two potential contributions to criticality at the SDA.

- Minimum concentration of fissile material required to achieve in-situ criticality in the waste trenches
- Mobilization, transport, and deposition of fissile materials through groundwater pathways over a 15,000-year period

The in-situ criticality analyses applied conservatively bounding assumptions of a spherical geometry, a water-saturated SiO₂ matrix, a dry SiO₂ reflector, and no neutron absorption by U-238 in the waste material. The mobilization and transport analyses determined the minimum slab thickness that is required to achieve a critical density, assuming that the fissile material could be deposited in a uniform layer at a soil transition zone.

The study concluded that an in-situ critical geometry cannot be achieved at the SDA locations which contain the largest concentrations of fissile materials. The study also concluded that criticality due to mobilization, transport, and deposition of fissile material within the 15,000-year analysis period is not a credible event.

The analyses in Reference 5.1-8 were based on the best available information regarding the waste inventories and the material distribution throughout the SDA trenches. Extensive efforts have since been made to refine the earlier data. The most comprehensive and detailed summary of the SDA waste inventories is documented in Reference 5.1-9, which is the primary

source of radionuclide data for this study. Those data are summarized in Table 4-2, and the detailed trench radionuclide inventories are reproduced in Appendix 4A.

Table 5.1-3 compares the fissile nuclide inventories in each trench from Reference 5.1-8 and Reference 5.1-9. Reference 5.1-8 does not document the inventories for Trenches 9 and 10, and no explanation for the omission is provided.

The current database contains a substantially larger inventory of U-235 than the earlier data. This difference is potentially important to the conclusions from the 1998 study, because U-235 is the predominant fissile material in the trenches. The current database, including Trenches 9 and 10, also shows differences in the inventories and distribution of U-233 and Pu-239. However, those differences are not significant to the results, due to the relatively small inventory of each nuclide.

The 1998 data indicated that Trench 4 contains approximately 62% of the total site inventory of U-235. The current data also indicate that Trench 4 contains the most U-235, with approximately 39% of the total site inventory. Several other trenches also contain significant amounts of U-235. For example, Trench 8 contains approximately 17% of the total, Trench 14 contains approximately 9% of the total, and Trenches 5, 9, 10, 11, 12, and 13 each contain between 5% and 7% of the total.

The detailed inventory data in Appendix 4A were examined to determine which trench sections contain the highest concentrations of U-235. That examination confirmed that four burial intervals in Trench 4 contain significantly higher concentrations of U-235 than any other trench at the site. Thus, Trench 4 remains the most limiting trench with respect to potential criticality.

The 1998 data indicated that Section 650 of Trench 4 contains approximately 169 kg of U-235. Therefore, that burial section was used to estimate the limiting concentration of fissile material for the in-situ criticality analyses and the mobilization and deposition analyses. Table 5.1-4 compares the current data for the distribution of U-235 in Trench 4 with the 1998 data. The current data show that the largest amounts of U-235 are present in Section 300-349 and Section 600-649 (approximately 118 kg in each section). Thus, the 169 kg of U-235 in Section 650 that was used in the 1998 study provides a conservative bound for the concentration of U-235 in any SDA trench section according to the current data.

Based on these comparisons, it was concluded that the 1998 study results remain conservatively bounding, and potential nuclear criticality was screened from further consideration in the SDA risk assessment.

5.1.2.4 Radiolytic / Chemical Interactions

All available samples and inspections performed since the wastes were buried indicate that the materials are in a stable form. There is no operating experience from the SDA or other similar waste facilities to indicate that unexpected radiolytic or chemical interactions within the waste material matrix may have a significant influence on the likelihood of potential releases from the trenches.

The SDA risk assessment includes a characterization of the chemical properties and radionuclide composition of the waste materials at the time of their release into the environment. To the extent possible, this characterization accounts for the effects from normal

radioisotopic decay, decomposition of packaging and waste materials, and other aging-related effects over the period from initial burial until the time of release. Therefore, this potential threat was screened from further consideration as a potentially unique contributor to the SDA risk assessment.

5.1.2.5 Soil Shrink / Swell / Consolidation

Potential impacts from variations in the site soil conditions are included in the SDA risk assessment. These variations are incorporated in the models and analyses for groundwater flows, and in the evaluations of potential slope failures at the SDA peripheries.

5.1.3 References

- 5.1-1. "PRA Procedures Guide: A Guide to the Performance of Probabilistic Risk Assessments for Nuclear Power Plants", NUREG/CR-2300, Volume 2, Chapter 10, January 1983
- 5.1-2. "Draft Environmental Impact Statement for Decommissioning and/or Long-Term Stewardship at the West Valley Demonstration Project and Western New York Nuclear Service Center", DOE/EIS-0226-R, United States Department of Energy and New York State Energy Research and Development Authority, draft for internal review, 2008
- 5.1-3. "West Valley Demonstration Project, Safety Analysis Report for Waste Processing and Support Activities", WVNS-SAR-001, Revision 11, West Valley Nuclear Services Company, June 2007
- 5.1-4. "A Comprehensive Literature Review of Liner Failures and Longevity", Reddy, D. V., and B. Butul, Center for Marine Structures and Geotechnique, Department of Ocean Engineering, Florida Atlantic University, July 1999
- 5.1-5. E-mail communications, M. R. Weishan, NYSERDA, to J. W. Stetkar, June 30, 2008 and August 1, 2008
- 5.1-6. E-mail communication, M. R. Weishan, NYSERDA, to J. W. Stetkar, July 31, 2008
- 5.1-7. E-mail communication, P. J. Bembia, NYSERDA, to J. W. Stetkar, April 29, 2009
- 5.1-8. "Criticality Assessment of Radioactive Waste Disposal Areas at the Western New York Nuclear Service Center", Dames and Moore, December 1998 (Attachment B to West Valley Nuclear Services Company transmittal letter MS-AOC-09, WD:1998:1577, December 18, 1998)
- 5.1-9. "SDA Radiological Characterization Report", Wild, R. E., prepared for West Valley Nuclear Services Company, Inc., URS Corporation, 2002

Table 5.1-1. Potential SDA Threats (page 1 of 3)

- Aircraft Crashes
 - Commercial
 - General aviation
 - Military
- Avalanches
- Biological Events
- Corrosion / Deterioration / Decomposition
 - Geomembrane covers
 - Crates, boxes
 - Steel drums
 - Tanks
- Drought
- Erosion
 - Coastal / lake shore
 - River banks
 - Local streams
 - Trenches
- Excavation of Contaminated Stream Sediments
- Explosions
- Extraterrestrial Impacts (e.g., asteroids, meteorites, space debris)
- Extreme Temperatures (heat, cold)
- Fires
 - Onsite facilities ("internal fires")
 - Offsite (e.g., grass fires, forest fires)
- Flooding Events
 - Onsite facilities ("internal flooding")
 - Extreme precipitation
 - Rapid snow melt
 - Dam failure
 - Site water supply pipe failure
 - Seiche
 - Storm surge
 - Tsunami
- Fog

Table 5.1-1. Potential SDA Threats (page 2 of 3)

- Frost
- Groundwater Intrusion
 - Historic intrusion
 - Rapid intrusion ("bath-tubbing")
- High Tides
- High Wind Events
 - Extreme sustained winds
 - Wind gusts
 - Tornadoes
- Hurricanes
- Ice Cover
- Landslides
- Lightning
- Loss of External Power Supplies
- Low Lake or River Water Level
- Nearby Facility Accidents
 - Industrial
 - Chemical
 - Military
- NRC-Licensed Facility Decommissioning Activities
 - Direct accident impacts on SDA
 - Effects on site grading, surface water runoff, erosion
- Nuclear Criticality
- Pipeline Accidents
 - Site natural gas supply pipe
 - Other nearby pipelines
- Radiolytic / Chemical Interactions
- River Diversion

Table 5.1-1. Potential SDA Threats (page 3 of 3)

- Seismic Events
 - Direct seismic failures
 - Seismic-induced fires
 - Seismic-induced flooding (e.g., piping failures)
- Severe Storms (e.g., hail, snow, dust, sand storms)
- Sinkholes
- Site Intrusions (non-malicious) (e.g., after failure of long-term institutional controls)
 - Recreation
 - Housing
 - Farming
- Soil Shrink / Swell / Consolidation
- Toxic Gas Releases
- Transportation Accidents
 - Rail
 - Highway
 - Shipping
- Volcanic Activity

Table 5.1-2. Threats Included in the SDA Risk Assessment

Disruptive Events

- Aircraft Crashes
 - Commercial
 - General aviation
 - Military
- Erosion
 - Local streams
 - Trenches
- Extraterrestrial Impacts (meteorites)
- Fires
 - Offsite (e.g., grass fires, forest fires)
- Flooding Events
 - Extreme precipitation
 - Rapid snow melt
- High Wind Events
 - Extreme sustained winds
 - Wind gusts
 - Tornadoes
- Landslides
- Pipeline Accidents
 - Site natural gas supply pipe
- Seismic Events
 - Direct seismic failures
- Severe Storms (snow)

Nominal Events and Processes

- Corrosion / Deterioration / Decomposition
 - Geomembrane covers
 - Crates, boxes
 - Steel drums
- Groundwater Intrusion
 - Historic intrusion
 - Rapid intrusion ("bath-tubbing")
- Soil Shrink / Swell / Consolidation

Table 5.1-3. SDA Fissile Nuclide Inventories (page 1 of 3)

Trench	Nuclide	1998 Study (Reference 5.1-8)		Current Estimate (Reference 5.1-9)	
		Curies	Kilograms	Curies	Kilograms
1	U-233	0	0	5.89E-10	6.11E-11
	U-235	2.41E-02	1.11E+01	1.05E-02	4.87E+00
	Pu-239	1.97E-03	3.18E-05	4.02E-01	6.48E-03
	Total	2.61E-02	1.11E+01	4.13E-01	4.88E+00
2	U-233	0	0	1.05E-09	1.09E-10
	U-235	6.94E-02	3.21E+01	6.49E-03	3.00E+00
	Pu-239	6.18E+00	9.96E-02	1.84E+00	2.97E-02
	Total	6.25E+00	3.22E+01	1.85E+00	3.03E+00
3	U-233	1.49E-03	1.54E-04	1.55E-06	1.60E-07
	U-235	1.26E-01	5.81E+01	3.32E-02	1.54E+01
	Pu-239	1.15E+01	1.85E-01	1.03E+01	1.66E-01
	Total	1.16E+01	5.83E+01	1.03E+01	1.55E+01
4	U-233	3.13E-01	3.24E-02	5.31E-05	5.50E-06
	U-235	5.55E-01	2.57E+02	1.37E+00	6.34E+02
	Pu-239	1.54E+01	2.48E-01	3.11E+01	5.01E-01
	Total	1.63E+01	2.57E+02	3.25E+01	6.35E+02
5	U-233	5.74E-01	5.95E-02	4.56E-05	4.72E-06
	U-235	1.38E-02	6.39E+00	2.21E-01	1.02E+02
	Pu-239	3.21E+01	5.18E-01	2.01E+01	3.24E-01
	Total	3.27E+01	6.97E+00	2.03E+01	1.03E+02
6	U-233	0	0	0	0
	U-235	0	0	0	0
	Pu-239	0	0	0	0
	Total	0	0	0	0

Table 5.1-3. SDA Fissile Nuclide Inventories (page 2 of 3)

Trench	Nuclide	1998 Study (Reference 5.1-8)		Current Estimate (Reference 5.1-9)	
		Curies	Kilograms	Curies	Kilograms
7	U-233	0	0	2.22E-10	2.30E-11
	U-235	0	0	4.40E-04	2.03E-01
	Pu-239	0	0	1.73E-01	2.78E-03
	Total	0	0	1.73E-01	2.06E-01
8	U-233	6.09E-01	6.31E-02	6.69E-05	6.93E-06
	U-235	2.69E-02	1.24E+01	6.15E-01	2.84E+02
	Pu-239	3.09E+01	4.98E-01	2.07E+01	3.34E-01
	Total	3.15E+01	1.30E+01	2.13E+01	2.85E+02
9	U-233	N / A	N / A	2.46E+00	2.55E-01
	U-235	N / A	N / A	1.71E-01	7.92E+01
	Pu-239	N / A	N / A	5.81E+01	9.36E-01
	Total	N / A	N / A	6.07E+01	8.04E+01
10	U-233	N / A	N / A	1.75E-03	1.81E-04
	U-235	N / A	N / A	2.33E-01	1.08E+02
	Pu-239	N / A	N / A	2.84E+00	4.57E-02
	Total	N / A	N / A	3.07E+00	1.08E+02
11	U-233	2.72E-01	2.82E-02	7.15E-04	7.40E-05
	U-235	1.39E-02	6.44E+00	1.82E-01	8.40E+01
	Pu-239	1.13E+01	1.83E-01	4.80E-01	7.73E-03
	Total	1.16E+01	6.65E+00	6.63E-01	8.40E+01
12	U-233	1.87E-01	1.94E-02	3.66E-04	3.79E-05
	U-235	2.18E-02	1.01E+01	1.80E-01	8.30E+01
	Pu-239	8.75E+00	1.41E-01	2.71E+01	4.37E-01
	Total	8.96E+00	1.02E+01	2.73E+01	8.35E+01

Table 5.1-3. SDA Fissile Nuclide Inventories (page 3 of 3)

Trench	Nuclide	1998 Study (Reference 5.1-8)		Current Estimate (Reference 5.1-9)	
		Curies	Kilograms	Curies	Kilograms
13	U-233	9.39E-02	9.73E-03	9.41E-05	9.75E-06
	U-235	2.44E-02	1.13E+01	1.97E-01	9.10E+01
	Pu-239	3.95E+00	6.37E-02	1.06E+01	1.70E-01
	Total	4.07E+00	1.14E+01	1.08E+01	9.12E+01
14	U-233	1.26E-01	1.31E-02	1.14E-04	1.18E-05
	U-235	1.78E-02	8.25E+00	3.05E-01	1.41E+02
	Pu-239	5.30E+00	8.56E-02	3.49E-01	5.61E-03
	Total	5.44E+00	8.35E+00	6.53E-01	1.41E+02
All Trenches	U-233	2.18E+00	2.25E-01	2.46E+00	2.55E-01
	U-235	8.93E-01	4.13E+02	3.53E+00	1.63E+03
	Pu-239	1.25E+02	2.02E+00	1.84E+02	2.96E+00
	Total	1.28E+02	4.15E+02	1.90E+02	1.63E+03

Table 5.1-4. Distribution of U-235 in SDA Trench 4

Burial Section (ft)	0 - 49	50 - 99	100 - 149	150 - 199	200 - 249	250 - 299	300 - 349
1998 Data⁽¹⁾ (kg)	0.35	0.42	1.21	0.46	0.25	0.26	1.05
Current Data⁽²⁾ (kg)	19.17	4.46	2.41	7.17	5.37	48.69	117.96
<hr/>							
Burial Section (ft)	350 - 399	400 - 449	450 - 499	500 - 549	550 - 599	600 - 649	650 - 699
1998 Data⁽¹⁾ (kg)	0.50	0.13	0.41	0.50	82.70	169.00	
Current Data⁽²⁾ (kg)	0.84	12.85	112.16	69.74	16.69	118.36	98.27

Notes:

(1) Reference 5.1-8

(2) Reference 5.1-9

5.2 PRECIPITATION

Precipitation at the West Valley site contributes to conditions that may cause a release from the trenches (e.g., due to erosion, groundwater flows, or overtopping scenarios). Precipitation also affects subsequent mobilization of the waste materials and their transport through the interconnected streams in the area.

5.2.1 Data Sources

Historical precipitation data were compiled from regional weather stations and from the West Valley meteorological tower records.

5.2.1.1 Regional Weather Data

Regional meteorological data were compiled from the following National Weather Service reporting stations (Reference 5.2-1).

Station	ID	Distance from West Valley Site	Database Period	Daily Weather Data Records
Buffalo	KBUF	34 miles North	January 1, 1922 – April 30, 2008	30, 573
Dunkirk	KDKK	32 miles West	January 1, 1926 – April 30, 2008	28,631
Jamestown	KJHW	37 miles Southwest	September 9, 1960 – October 31, 1962; January 1, 1973 – April 30, 2008	11,110

Each daily weather record contains the following data.

- Date
- High temperature (°F)
- Low temperature (°F)
- Average temperature (°F)
- High dew point (°F)
- Low dew point (°F)
- Average dew point (°F)
- High relative humidity (%)
- Low relative humidity (%)
- Average relative humidity (%)
- High barometric pressure (in)
- Low barometric pressure (in)
- Average barometric pressure (in)

- High visibility (mi)
- Low visibility (mi)
- Average visibility (mi)
- High wind speed (mph)
- Average wind speed (mph)
- High gust wind speed (mph)
- Total precipitation (in)

Some records do not contain entries for all data fields. For example, early year records typically contain only temperature and precipitation data.

The data records for some years are not complete. In some cases, a few weeks or a few months of data are missing. Gaps are particularly notable in the Jamestown records. No attempt was made to determine the cause for the missing records or to recover the missing data from other possible sources.

The raw precipitation data were edited to remove the following records.

- The records for some years do not contain any precipitation data. All daily precipitation entries in these records list no (0) precipitation for the entire year. This phenomenon seems to be associated with transcription or coding errors during transitions to the more complete data reporting format in later years. These records do not contain meaningful precipitation data. Therefore, they were removed from the database that was used for this study.
- The precipitation records for Jamestown before 1998 are very sparse. Therefore, all pre-1998 Jamestown precipitation records were removed from the database. The Jamestown precipitation records after 1998 also seem rather erratic. They were retained in the database, but they may not be reliable.

The affected records are summarized below.

Station	Total Raw Daily Weather Records	Records with No Precipitation Data	Records Retained for Precipitation Analyses
Buffalo	30, 573	1,430	29,143
Dunkirk	28,631	1,797	26,834
Jamestown	11,110	7,486	3,624

The retained records were also reviewed for errors and obvious anomalies. These reviews resulted in the following modifications to the raw data.

- Some precipitation data for Buffalo are recorded with the letter "T" (trace). These entries were changed to 0.001 inch to distinguish them from zero (0) precipitation.

- Some precipitation data entries are clearly wrong (e.g., totals of more than several feet in 1 day). All daily weather records with precipitation totals of 5 inches or more were reexamined to confirm the validity of the recorded entries. If they were available, hourly weather records were used to correct erroneous values.

The detailed raw data records are retained in the project files, with annotations that document all edited values. However, due to their very large volume, they are not reproduced in this report.

5.2.1.2 West Valley Site Weather Data

Data from the West Valley site meteorological tower were available for the period from January 1, 1991, through December 31, 2007 (Reference 5.2-2). These data included:

- Daily total precipitation
- Maximum hourly wind speed per year at 10-meter and 60-meter elevations

The West Valley data were compared with the regional data over the same time period to determine whether any significant site-specific differences exist.

Comparisons of West Valley and Regional Precipitation Data, 1991 – 2007				
Parameter	West Valley	Buffalo	Dunkirk	Jamestown⁽¹⁾
Maximum 24-hour precipitation (in.)	3.75	3.24	2.76	2.42
Average daily precipitation (in.)	0.109	0.130	0.096	0.029
Average daily precipitation difference ⁽²⁾ (in.)	--	- 0.02	+ 0.01	+ 0.08
Notes:				
(1) Jamestown precipitation data from 1/1/1998 – 12/31/2007				
(2) Difference is West Valley minus Regional (positive value indicates West Valley higher)				

The "maximum 24-hour precipitation" entries in this table show the maximum precipitation that was recorded during any 24-hour period at each station during the common 1991 – 2007 reporting period. The "average daily precipitation" entries list the average daily precipitation for each station, accounting for all of the reported data during the same period. The "average daily precipitation difference" shows the extent to which the average precipitation data from the three regional reporting stations match the West Valley site data. For example, the entry for Buffalo shows that the average daily precipitation at Buffalo during this 17-year period was approximately 0.02 inch more than the average daily precipitation at West Valley. However, the average daily precipitation at West Valley was approximately 0.01 inch more than the average daily precipitation recorded at Dunkirk, and approximately 0.08 inch more than that recorded at Jamestown (although the Jamestown records are somewhat erratic and cover only the period from 1998 through 2007).

From these comparisons, it is evident that the Buffalo data provide the best estimate of long-term precipitation for the West Valley area. Of course, the data are not perfectly correlated, because intense storms are often very localized. For example, the 3.75-inch maximum precipitation at West Valley occurred on June 26, 1998. The Buffalo precipitation for that day was 0.30 inch. The 3.24-inch maximum precipitation at Buffalo occurred on September 9, 2004. The West Valley precipitation for that day was 1.90 inches. However, since the 17 years of data from Buffalo and West Valley are generally quite similar, these localized episodic differences do not have a significant effect on the long-term precipitation exceedance frequencies.

5.2.2 Extrapolation of Historic Experience

According to Section 3.4.2.3 of the WVDP Safety Analysis Report (Reference 5.2-3), the 24-hour Probable Maximum Precipitation (PMP) for the site is 24.9 inches. It is noted that this precipitation will overwhelm the site drainage systems and cause extensive damage.

More recent analyses performed in support of the Final Environmental Impact Statement are based on a revised 24-hour PMP value of 33.56 inches (Reference 5.2-4). The QRA analyses are based on precipitation exceedance frequency distributions that are derived from historical meteorological records. These continuous distributions explicitly account for the regional precipitation data, observed variabilities, and underlying uncertainties. The 25-inch nominal PMP value was originally used in this section as a truncation point for tabulations and displays of the continuous distributions. The change from a 24.9-inch PMP value to a 33.56-inch PMP value does not affect the precipitation exceedance frequency analyses or the QRA results. Therefore, the 25-inch truncation value is retained in the following discussions, tables, and figures.

Table 5.2-1 compares the historic experience for the maximum total precipitation over various time intervals at West Valley, Buffalo, Dunkirk, and Jamestown. To estimate the frequencies of very severe precipitation events that may release wastes from the SDA trenches, it was necessary to extrapolate this experience to conditions that are substantially beyond those observed in nearly a century of data for the surrounding region.

5.2.2.1 24-Hour Precipitation

Figure 5.2-1 plots the 24-hour precipitation exceedance frequencies for West Valley, Buffalo, Dunkirk, and Jamestown, based on the available historic data. These curves were produced by sorting the raw data for 24-hour total precipitation and computing the annual frequency of events that exceed each respective total. The raw data plots were then smoothed to remove anomalies from sparse evidence at high precipitation totals. (Discrete transitions between singular large precipitation events produce irregularities when the data are plotted in the exceedance curve format. These irregularities were smoothed by interpolating between the observed data points.) The smoothing process retained the historical frequencies for the maximum observed precipitation totals at each reporting station, to preserve these end-point anchors for the data extrapolations.

Comparison of the West Valley and Buffalo curves shows that West Valley has a slightly lower frequency of precipitation in the 1.5-inch to 3-inch accumulation range. However, the exceedance frequency for totals over 3 inches is approximately the same as that for Buffalo.

The historical experience from Dunkirk is very similar to that of West Valley and Buffalo for precipitation totals up to approximately 3.5 inches. However, the Dunkirk exceedance frequencies are measurably higher for larger totals. The curves also clearly show the significant differences in the Jamestown data.

The exceedance frequency data from Buffalo, Dunkirk, and Jamestown were next extrapolated to a 24-hour total of 25 inches (i.e., the West Valley PMP value). The West Valley data were not extrapolated, because the site experience is bounded by the larger database from the regional weather stations. As noted in Table 5.2-1, the maximum recorded 24-hour precipitation at any station was 6.88 inches at Dunkirk. The database contains only three records with precipitation totals that exceed 5 inches. Therefore, extrapolation of the historic exceedance curves to very large values is, at best, an approximate process. The extrapolated curves exhibit increasing divergence at higher precipitation totals, as a result of the variability in the reported experience from the three stations. This behavior is typical, and it provides a measure of the uncertainty in the estimated exceedance frequencies. Figure 5.2-2 shows the extrapolated curves.

5.2.2.2 48-Hour, 3-Day, 7-Day, and 14-Day Cumulative Precipitation

A similar process was used to derive exceedance curves for 48-hour, 3-day, 7-day, and 14-day cumulative precipitation totals at each reporting station. The historic data were then extrapolated to a nominal cumulative total of 25 inches. (The 25-inch PMP bound was used for these cumulative precipitation curves to provide a consistent reference point for comparison of the respective exceedance frequencies.) Figures 5.2-3 through 5.2-10 show the results from the historic experience and the extrapolations for these time periods.

It is noteworthy that the Dunkirk exceedance frequencies are consistently higher than those at Buffalo for 24-hour, 48-hour, 3-day, and 7-day precipitation totals. However, this situation does not apply for 14-day precipitation totals above approximately 3 inches, where the Buffalo exceedance frequencies are higher than all other reporting stations.

5.2.3 Composite Precipitation Exceedance Curves

The precipitation exceedance frequencies for this study are derived from composite uncertainty distributions that account for the historic experience and the extrapolated projections for each reporting station. The Buffalo precipitation data were used as the best estimate (median) for the composite exceedance curves because the West Valley site-specific experience most closely matches that of Buffalo. The ranges of precipitation data from Dunkirk, Jamestown, and West Valley were used as input to the uncertainty analyses.

5.2.3.1 24-Hour Precipitation

Lognormal uncertainty distributions were fit to the extrapolated curves to develop estimates of the exceedance frequency over the range of 24-hour precipitation totals. These distributions preserve the median estimates from Buffalo. The Dunkirk estimates were used as the 95th percentile of the uncertainty distribution. The lognormal approximations are somewhat narrower than the observed data variability at low precipitation totals. For example, the 5th percentile frequency of the lognormal distribution is generally higher than the historical experience from Jamestown. However, as noted previously, the reported data for Jamestown are somewhat erratic, the database period is more limited, and the precipitation totals are

consistently much lower than the other reporting stations, including the West Valley site. Therefore, without further investigation of the causes for these disparities, it seems reasonable that the Jamestown data may fall outside the 90% confidence interval for the lognormal uncertainties. The 90% confidence intervals for the composite distributions encompass the extrapolated Jamestown estimates for high precipitation values, where much larger uncertainties apply.

Figure 5.2-11 shows the resulting composite 24-hour precipitation exceedance curves that are used in the SDA risk analyses. Table 5.2-2 lists the parameter values that were used to develop the curves.

5.2.3.2 48-Hour, 3-Day, 7-Day, and 14-Day Cumulative Precipitation

The same process described in Section 5.2.3.1 was used to develop composite exceedance curves for 48-hour, 3-day and 7-day cumulative precipitation totals. The Buffalo data were used as the best estimate (median) values, and the Dunkirk data were used as the 95th percentiles of lognormal uncertainty distributions. The lower bounds of the 90% confidence intervals of these distributions generally lie above the historical Jamestown data at low precipitation totals. The lower bounds of the uncertainty distributions encompass the extrapolated Jamestown estimates for high cumulative total precipitation.

The 14-day cumulative precipitation data show that Buffalo has higher totals and higher exceedance frequencies than Dunkirk and Jamestown. The Buffalo data were retained in this analysis as the best estimate of long-term precipitation for the West Valley area. However, since both the Dunkirk and Jamestown exceedance frequencies are lower than those for Buffalo, the Dunkirk data could not be used as a measure of the upper uncertainty range for the 14-day cumulative precipitation exceedance curves, as was done in the 24-hour, 3-day, and 7-day analyses. In this case, uncertainty distributions were developed using the Buffalo data as the median estimate. Lognormal error factors that are somewhat larger than those derived for the 3-day and 7-day analyses were assigned to account for the greater uncertainty in the 14-day exceedance frequencies. The assigned uncertainties span the observed experience at Dunkirk and West Valley. However, extrapolation of the very sparse experience and low rainfall totals from Jamestown produces estimated exceedance frequencies that are well outside the lower bounds of the uncertainty distributions, especially at very high precipitation totals. Thus, the 14-day exceedance frequencies derived from this analysis may be somewhat conservative, because the uncertainties do not fully capture the Jamestown extrapolations.

Figures 5.2-12 through 5.2-15 show the 48-hour, 3-day, 7-day, and 14-day composite precipitation exceedance curves that are used in the SDA risk analyses. Tables 5.2-3 through 5.2-6 list the parameter values that were used to develop the curves.

5.2.4 References

5.2-1. www.wunderground.com

5.2-2. E-mail communication, P. J. Bembia, NYSERDA, and C. M. Bohan, DOE, to J. W. Stetkar, June 5, 2008

- 5.2-3. "West Valley Demonstration Project, Safety Analysis Report for Waste Processing and Support Activities", WVNS-SAR-001, Revision 11, West Valley Nuclear Services Company, June 2007
- 5.2-4. URS Corporation Memorandum to Science Applications International Corporation, Subject: Probable Maximum Flood Inundation Study, West Valley, New York, August 28, 2008. Cited in e-mail communication, J. C. Kelly, NYSERDA, to J. W. Stetkar, July 20, 2009

Table 5.2-1. Historic Maximum Total Precipitation									
Time Interval	West Valley		Buffalo		Dunkirk		Jamestown		Date
	Amount (in.)	Date	Amount (in.)	Date	Amount (in.)	Date	Amount (in.)	Date	
24 Hours	3.75	June 26, 1998	5.01	June 22, 1987	6.88	August 22, 1942	2.42	May 24, 2004	
48 Hours	4.13	August 30-31, 2005	6.43	June 21-22, 1987	6.99	August 22-23, 1942	3.08	May 23-24, 2004	
3 Days	4.13	August 2005	6.43	June 1987	6.99	August 1942	3.50	May 2004	
7 Days	4.78	July 1998	7.20	June 1987	8.45	September 1977	3.91	May 2004	
14 Days	6.49	September 2004	12.33	October 1974	10.75	September 1977	4.20	May 2004	
Database Periods:									
West Valley:	January 1, 1991 – December 31, 2007								
Buffalo:	January 1, 1922 – April 30, 2008								
Dunkirk:	January 1, 1926 – November 12, 2007								
Jamestown:	January 1, 1998 – April 30, 2008								

Table 5.2-2. Parameters for SDA QRA 24-Hour Precipitation Exceedance Curves

24-Hour Precipitation (inches)	Exceedance Frequency (event / year)				
	5th Percentile	Median	Mean	95th Percentile	Error Factor
1.0	5.12E+00	5.48E+00	5.48E+00	5.86E+00	1.07
2.0	3.73E-01	4.89E-01	4.96E-01	6.41E-01	1.31
3.0	9.17E-02	1.00E-01	1.00E-01	1.09E-01	1.09
4.0	2.40E-02	3.10E-02	3.14E-02	4.00E-02	1.29
5.0	6.51E-03	1.25E-02	1.35E-02	2.40E-02	1.92
6.0	2.25E-03	6.00E-03	7.17E-03	1.60E-02	2.67
7.5	5.95E-04	2.50E-03	3.66E-03	1.05E-02	4.20
10.0	1.02E-04	7.50E-04	1.56E-03	5.50E-03	7.33
12.5	2.08E-05	2.50E-04	7.82E-04	3.00E-03	12.00
15.0	5.71E-06	1.00E-04	4.54E-04	1.75E-03	17.50
17.5	2.02E-06	4.50E-05	2.67E-04	1.00E-03	22.30
20.0	6.67E-07	2.00E-05	1.70E-04	6.00E-04	30.00
22.5	2.50E-07	1.00E-05	1.24E-04	4.00E-04	40.00
25.0	1.00E-07	5.00E-06	8.45E-05	2.50E-04	50.00

Table 5.2-3. Parameters for SDA QRA 48-Hour Precipitation Exceedance Curves

48-Hour Precipitation (inches)	Exceedance Frequency (event / year)				
	5th Percentile	Median	Mean	95th Percentile	Error Factor
1.0	1.36E+01	1.48E+01	1.48E+01	1.61E+01	1.09
2.0	1.90E+00	2.09E+00	2.09E+00	2.30E+00	1.10
3.0	3.25E-01	4.00E-01	4.03E-01	4.92E-01	1.23
4.0	7.69E-02	1.00E-01	1.01E-01	1.30E-01	1.30
5.0	1.85E-02	3.50E-02	3.77E-02	6.62E-02	1.89
6.0	6.40E-03	1.60E-02	1.87E-02	4.00E-02	2.50
7.5	2.23E-03	6.70E-03	8.37E-03	2.01E-02	3.00
10.0	5.00E-04	2.00E-03	2.85E-03	8.00E-03	4.00
12.5	1.17E-04	7.00E-04	1.27E-03	4.20E-03	6.00
15.0	4.29E-05	3.00E-04	6.04E-04	2.10E-03	7.00
17.5	1.56E-05	1.25E-04	2.78E-04	1.00E-03	8.00
20.0	5.45E-06	6.00E-05	1.74E-04	6.60E-04	11.00
22.5	2.22E-06	3.00E-05	1.05E-04	4.05E-04	13.50
25.0	8.33E-07	1.50E-05	7.02E-05	2.70E-04	18.00

Table 5.2-4. Parameters for SDA QRA 3-Day Precipitation Exceedance Curves

3-Day Precipitation (inches)	Exceedance Frequency (event / year)				
	5th Percentile	Median	Mean	95th Percentile	Error Factor
1.0	2.51E+01	2.69E+01	2.69E+01	2.88E+01	1.07
2.0	4.23E+00	4.40E+00	4.40E+00	4.58E+00	1.04
3.0	7.90E-01	9.40E-01	9.45E-01	1.12E+00	1.19
4.0	2.16E-01	2.50E-01	2.51E-01	2.90E-01	1.16
5.0	7.44E-02	9.00E-02	9.06E-02	1.09E-01	1.21
6.0	2.12E-02	3.50E-02	3.67E-02	5.78E-02	1.65
7.5	4.03E-03	1.10E-02	1.33E-02	3.00E-02	2.73
10.0	7.23E-04	3.00E-03	4.36E-03	1.25E-02	4.15
12.5	1.67E-04	1.00E-03	1.81E-03	6.00E-03	6.00
15.0	5.33E-05	4.00E-04	8.47E-04	3.00E-03	7.50
17.5	2.05E-05	1.75E-04	4.10E-04	1.50E-03	8.55
20.0	7.11E-06	8.00E-05	2.36E-04	9.00E-04	11.25
22.5	3.20E-06	4.00E-05	1.30E-04	5.00E-04	12.50
25.0	1.33E-06	2.00E-05	7.75E-05	3.00E-04	15.00

Table 5.2-5. Parameters for SDA QRA 7-Day Precipitation Exceedance Curves

7-Day Precipitation (inches)	Exceedance Frequency (event / year)				
	5th Percentile	Median	Mean	95th Percentile	Error Factor
1.0	8.89E+01	9.33E+01	9.33E+01	9.80E+01	1.05
2.0	2.20E+01	2.31E+01	2.31E+01	2.43E+01	1.05
3.0	6.72E+00	7.06E+00	7.06E+00	7.41E+00	1.05
4.0	1.62E+00	1.70E+00	1.70E+00	1.79E+00	1.05
5.0	5.90E-01	6.20E-01	6.20E-01	6.51E-01	1.05
6.0	1.60E-01	2.00E-01	2.02E-01	2.50E-01	1.25
7.5	3.57E-02	5.00E-02	5.11E-02	7.00E-02	1.40
10.0	5.00E-03	1.00E-02	1.09E-02	2.00E-02	2.00
12.5	1.12E-03	3.00E-03	3.59E-03	8.01E-03	2.67
15.0	2.50E-04	1.00E-03	1.43E-03	4.00E-03	4.00
17.5	8.00E-05	4.00E-04	6.46E-04	2.00E-03	5.00
20.0	2.46E-05	1.75E-04	3.57E-04	1.25E-03	7.12
22.5	7.04E-06	7.50E-05	2.11E-04	8.00E-04	10.66
25.0	2.45E-06	3.50E-05	1.29E-04	5.00E-04	14.28

Table 5.2-6. Parameters for SDA QRA 14-Day Precipitation Exceedance Curves

14-Day Precipitation (inches)	Exceedance Frequency (event / year)				
	5th Percentile	Median	Mean	95th Percentile	Error Factor
1.0	1.77E+02	2.21E+02	2.23E+02	2.76E+02	1.25
2.0	5.61E+01	8.41E+01	8.67E+01	1.26E+02	1.50
3.0	1.63E+01	3.26E+01	3.56E+01	6.52E+01	2.00
4.0	4.70E+00	1.41E+01	1.76E+01	4.23E+01	3.00
5.0	1.58E+00	6.33E+00	9.03E+00	2.53E+01	4.00
6.0	5.96E-01	2.98E+00	4.81E+00	1.49E+01	5.00
7.5	1.21E-01	9.10E-01	1.93E+00	6.83E+00	7.50
10.0	1.25E-02	1.25E-01	3.33E-01	1.25E+00	10.00
12.5	1.60E-03	2.00E-02	6.50E-02	2.50E-01	12.50
15.0	2.67E-04	4.00E-03	1.55E-02	6.00E-02	15.00
17.5	5.71E-05	1.00E-03	4.54E-03	1.75E-02	17.50
20.0	1.50E-05	3.00E-04	1.57E-03	6.00E-03	20.00
22.5	4.44E-06	1.00E-04	6.00E-04	2.25E-03	22.50
25.0	1.60E-06	4.00E-05	2.71E-04	1.00E-03	25.00

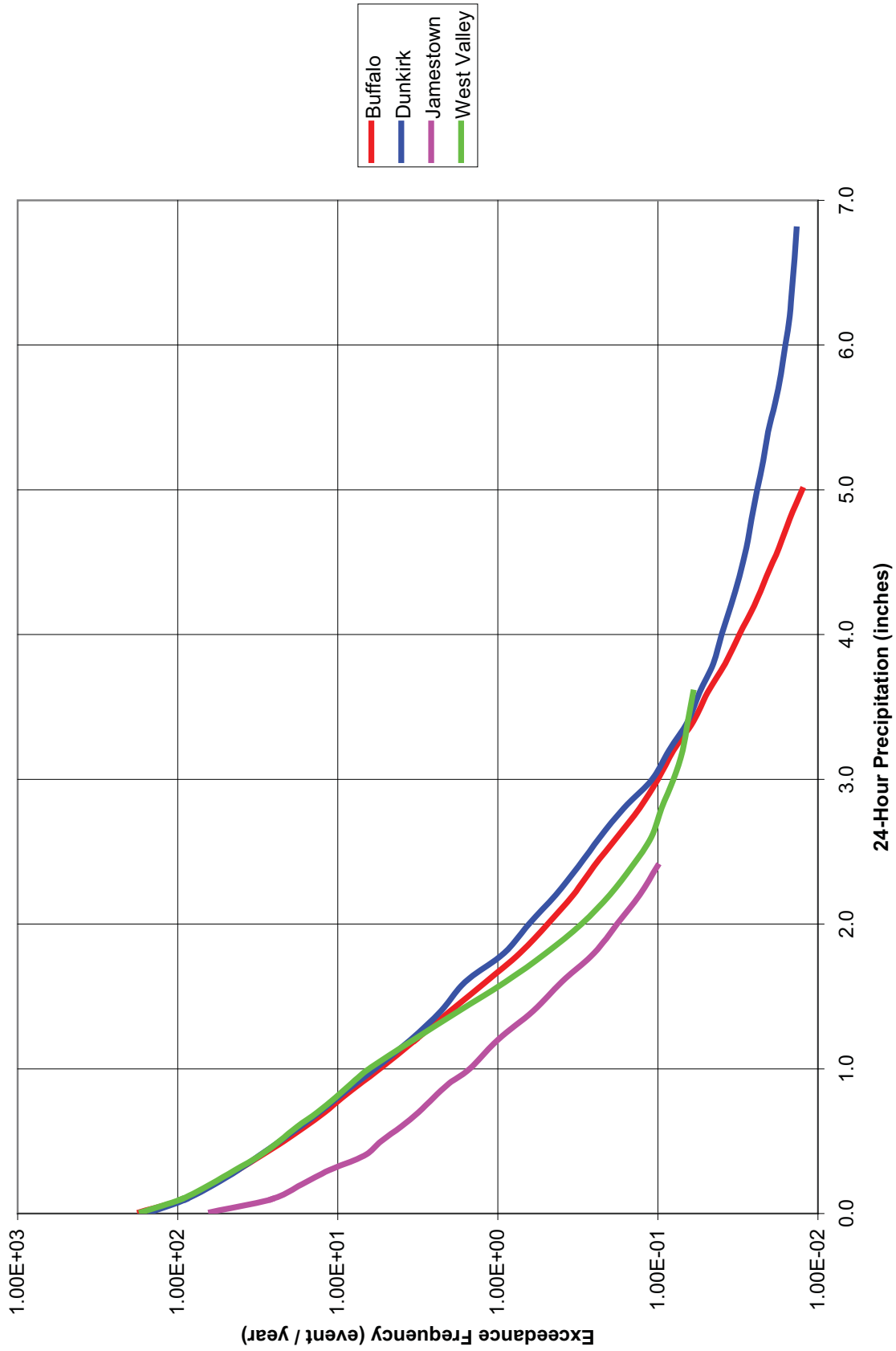

Figure 5.2-1. 24-Hour Precipitation Exceedance Curves, Historical Data

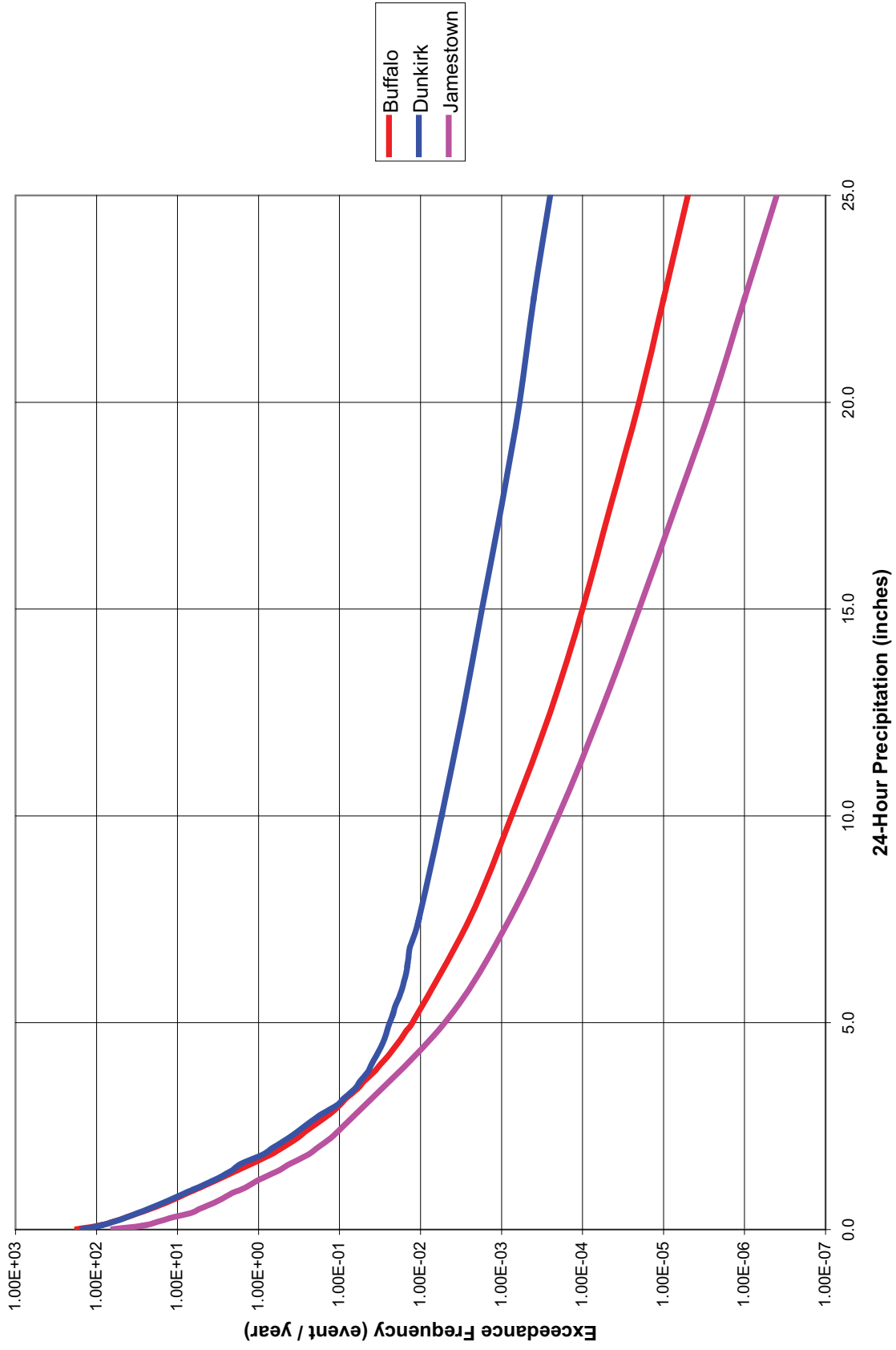

Figure 5.2-2. 24-Hour Precipitation Exceedance Curves, Extrapolated

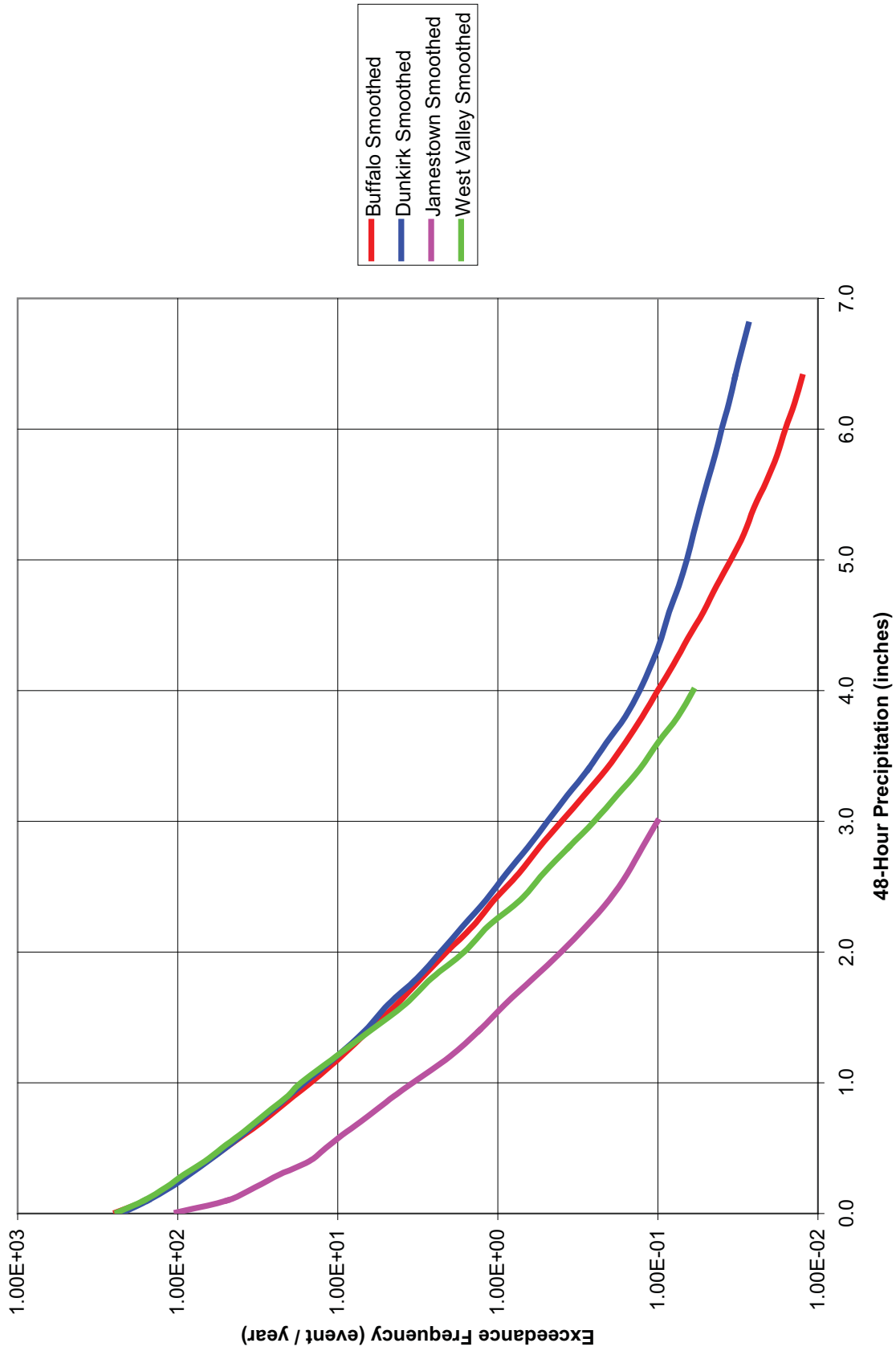

Figure 5.2-3. 48-Hour Precipitation Exceedance Curves, Historical Data

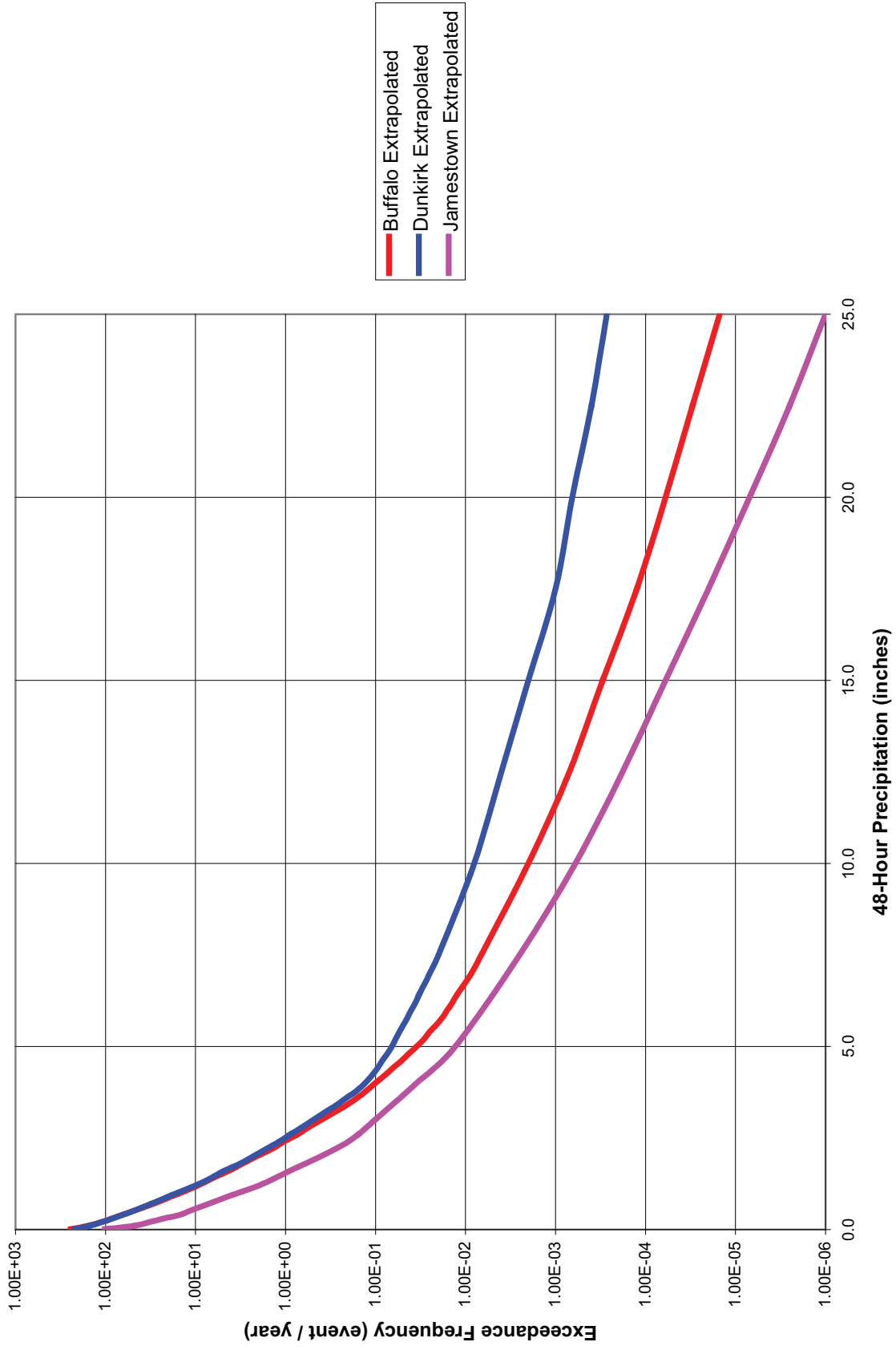

Figure 5.2-4. 48-Hour Precipitation Exceedance Curves, Extrapolated

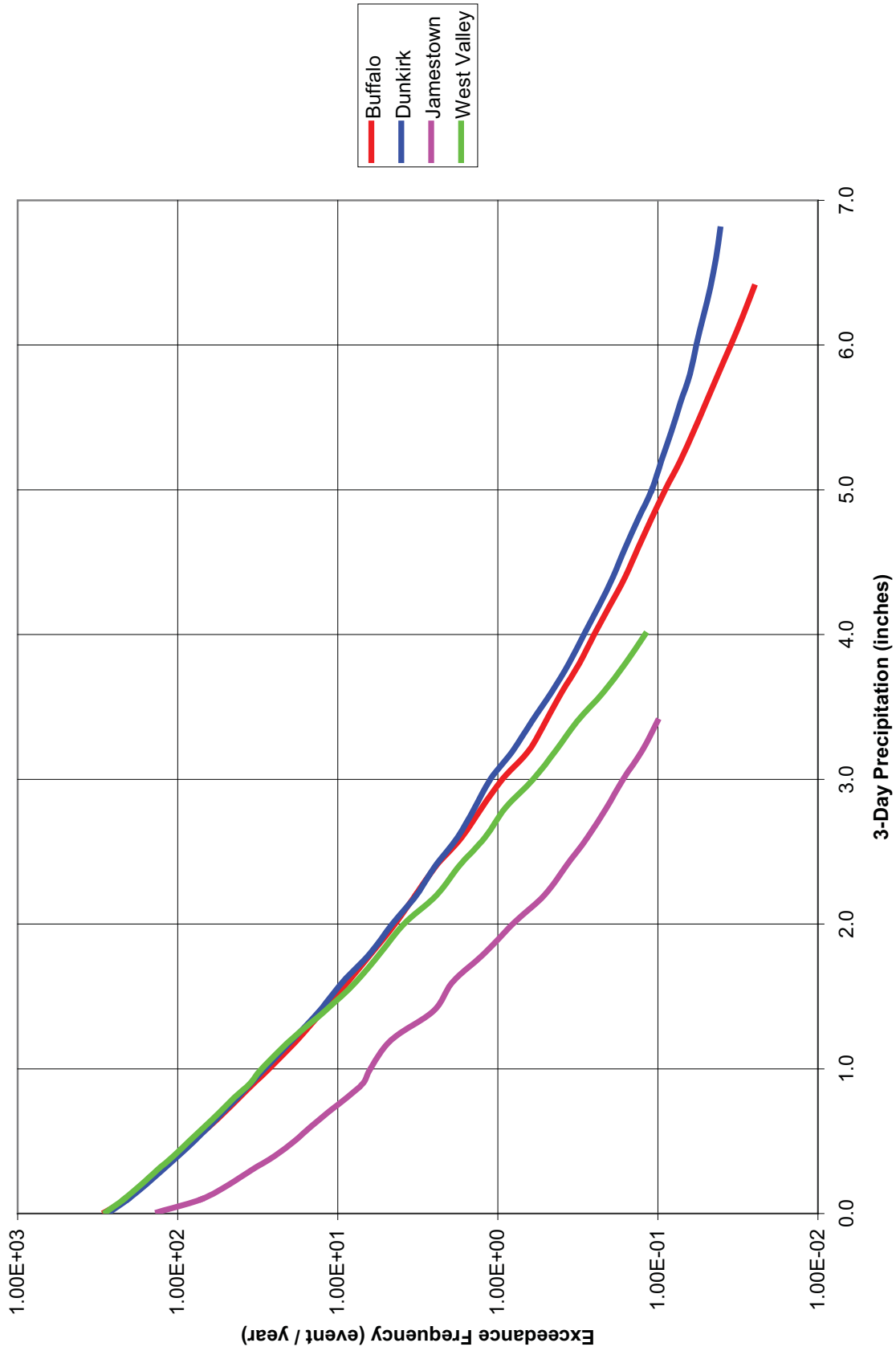

Figure 5.2-5. 3-Day Cumulative Precipitation Exceedance Curves, Historical Data

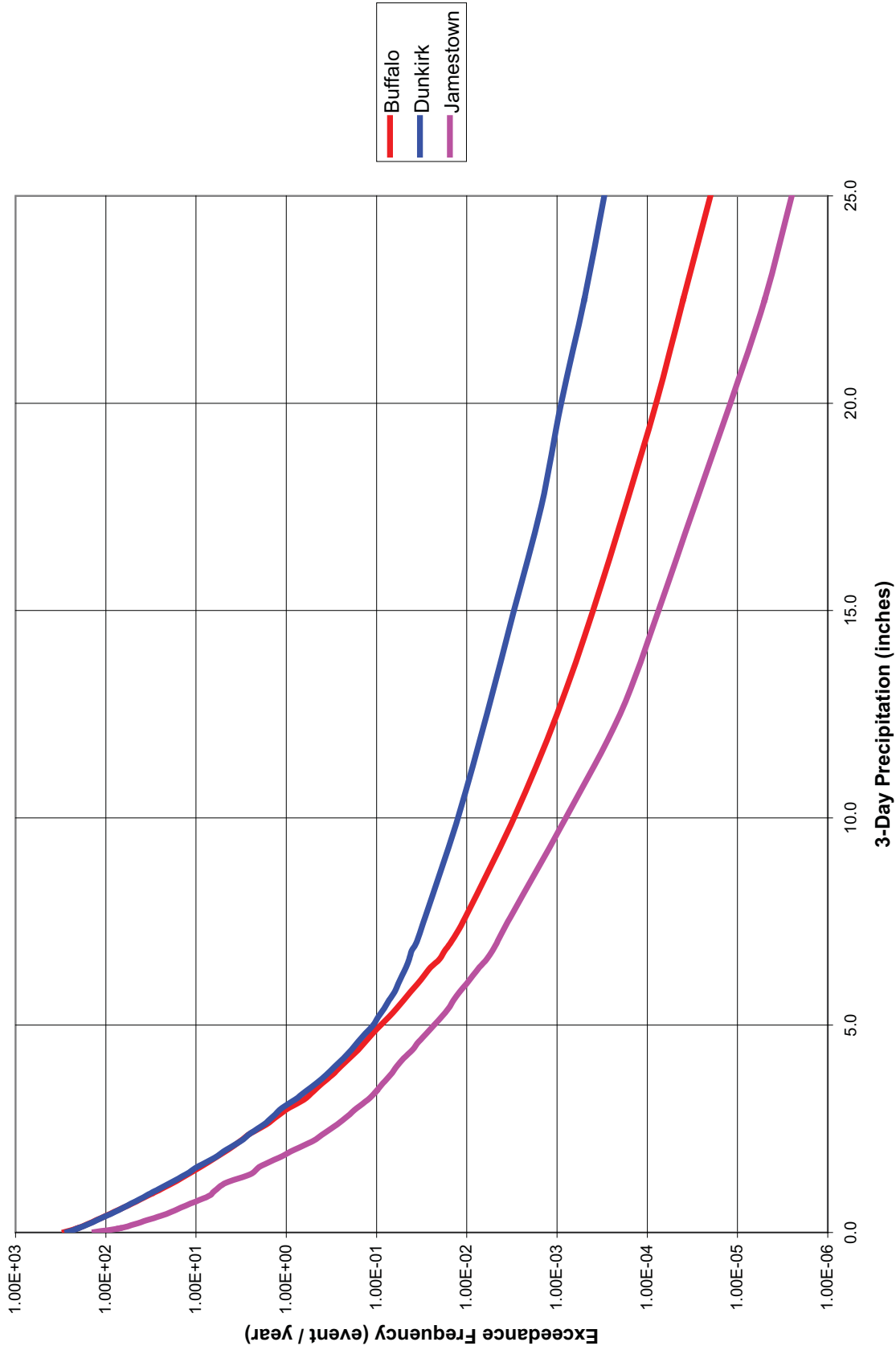

Figure 5.2-6. 3-Day Cumulative Precipitation Exceedance Curves, Extrapolated

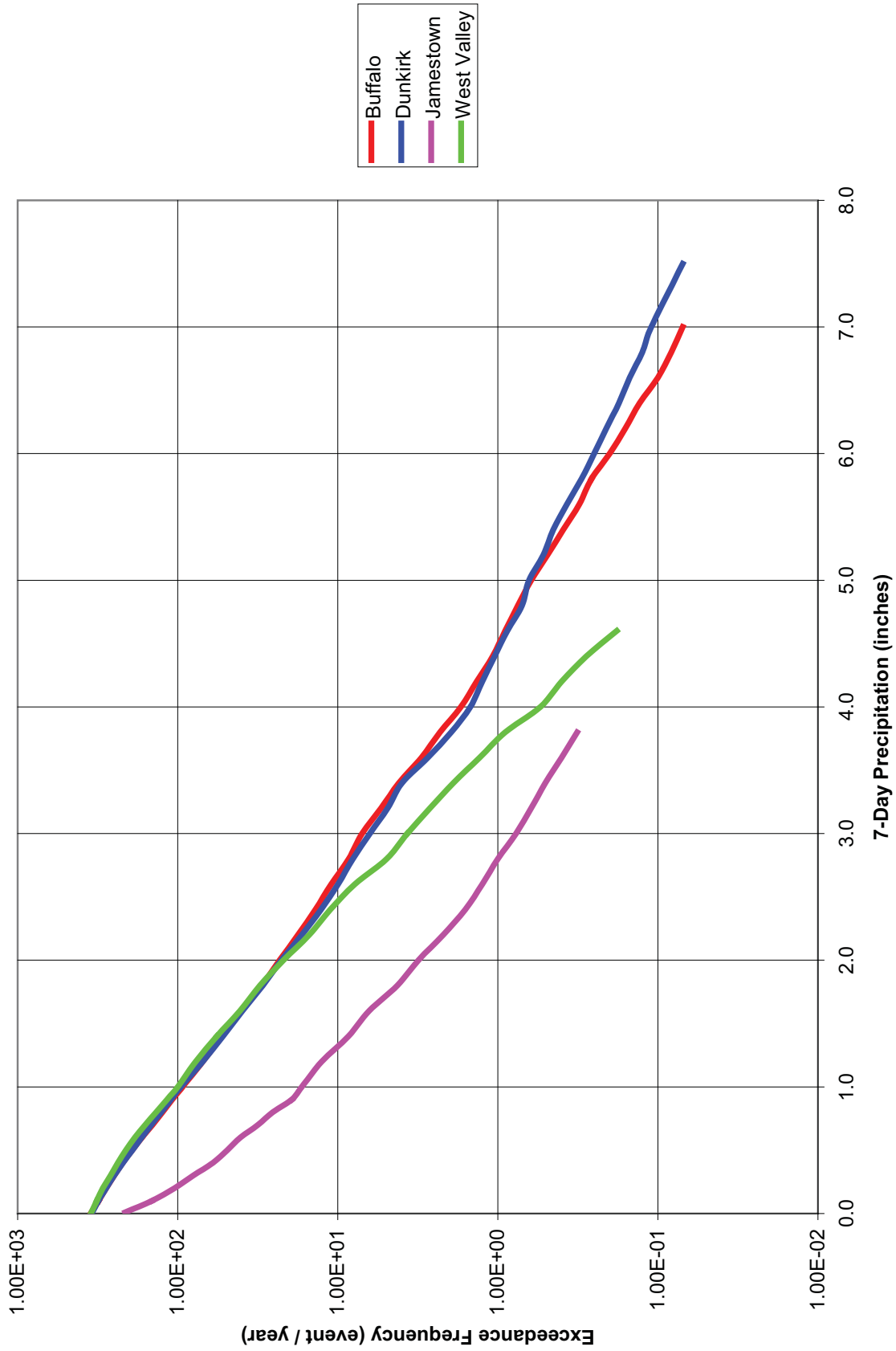

Figure 5.2-7. 7-Day Cumulative Precipitation Exceedance Curves, Historical Data

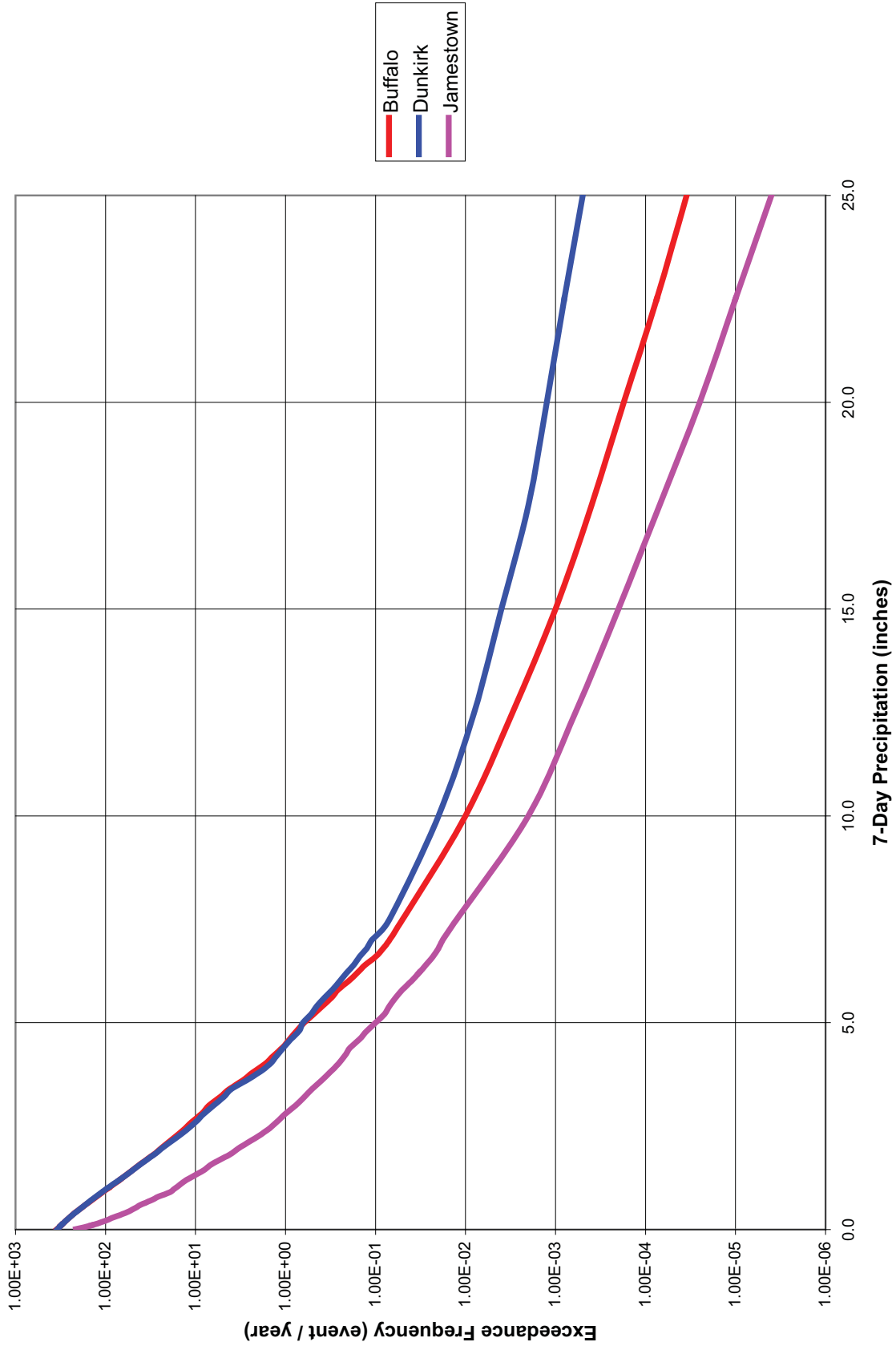

Figure 5.2-8. 7-Day Cumulative Precipitation Exceedance Curves, Extrapolated

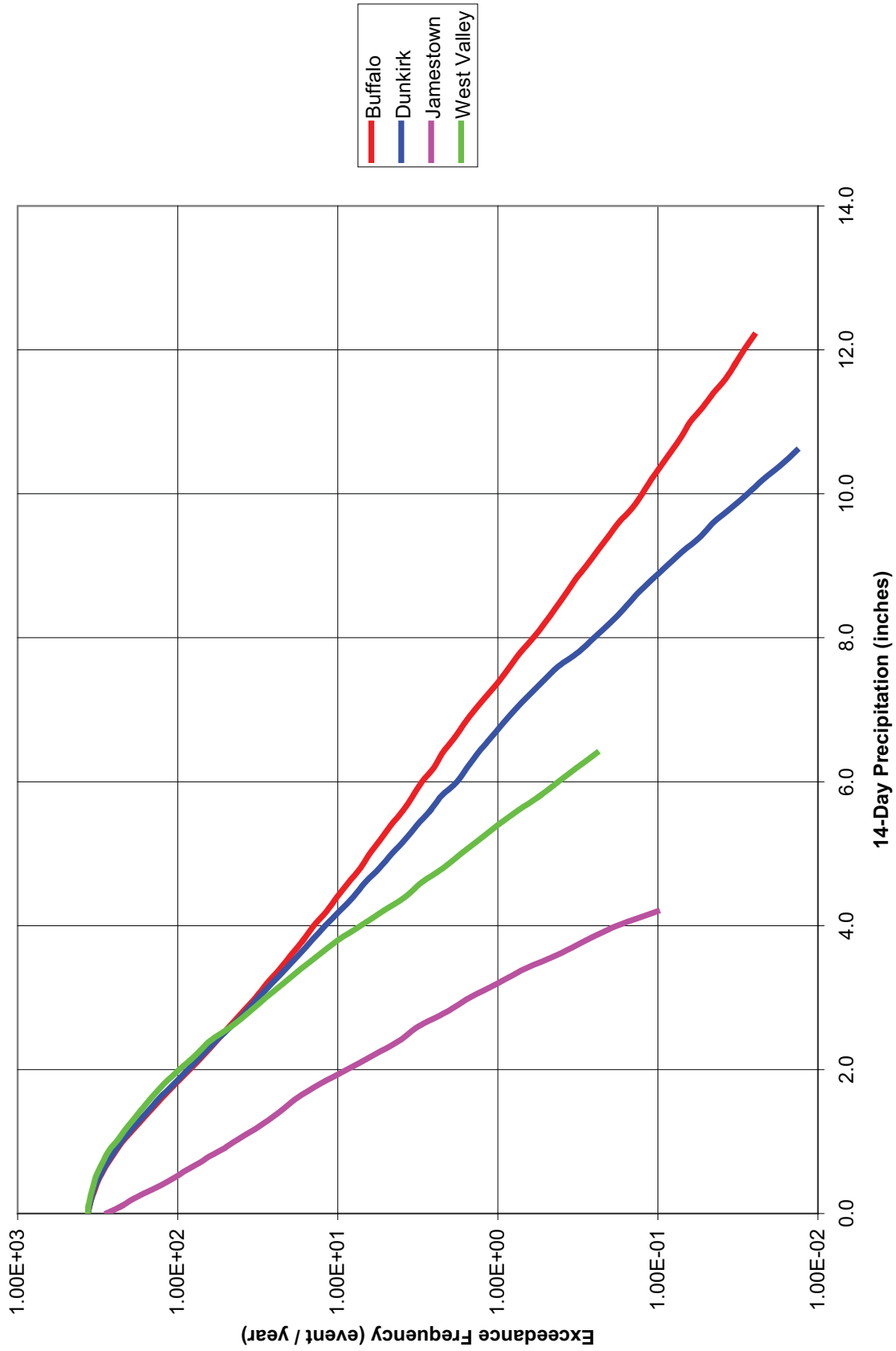

Figure 5.2-9. 14-Day Cumulative Precipitation Exceedance Curves, Historical Data

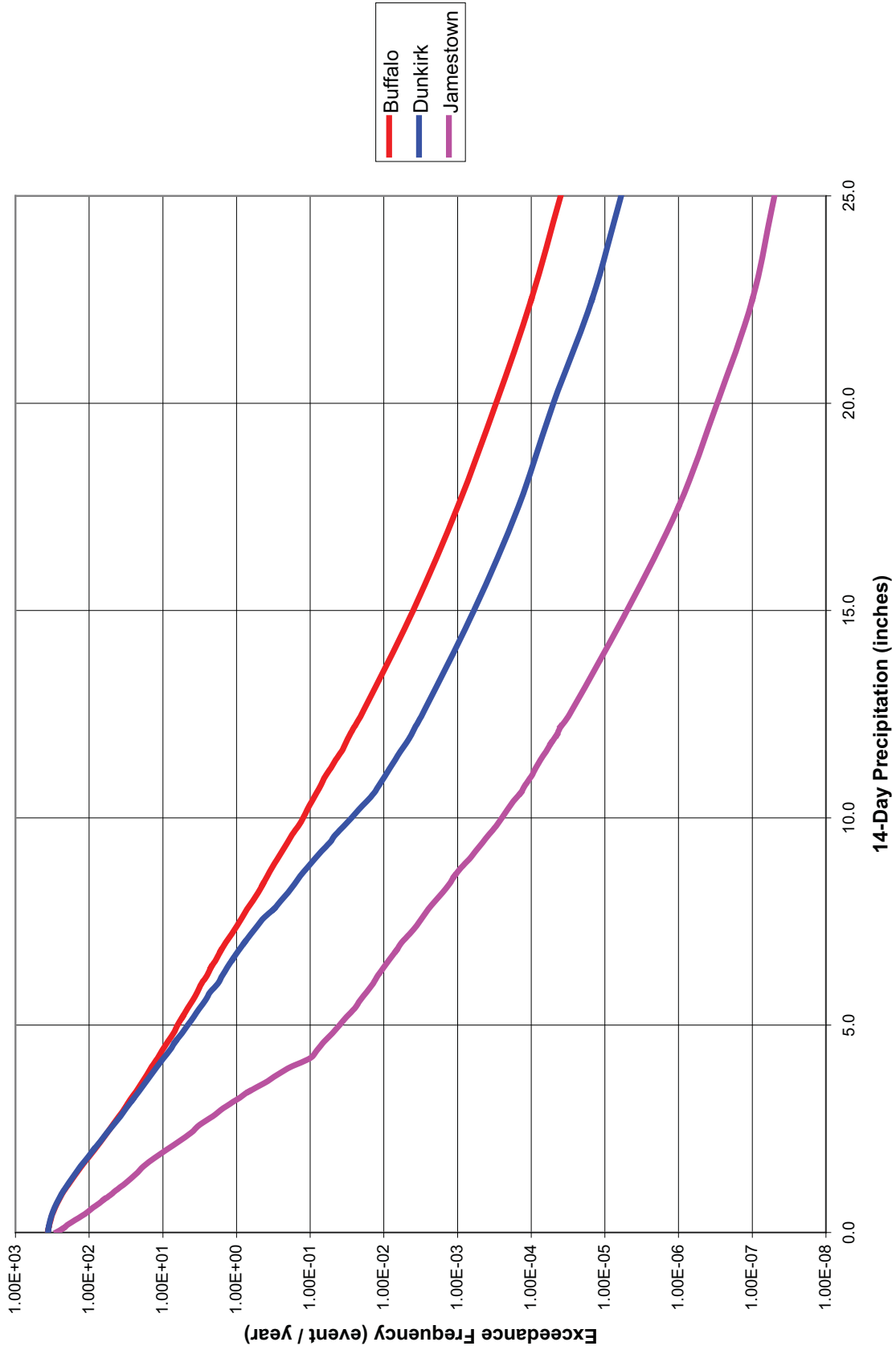

Figure 5.2-10. 14-Day Cumulative Precipitation Exceedance Curves, Extrapolated

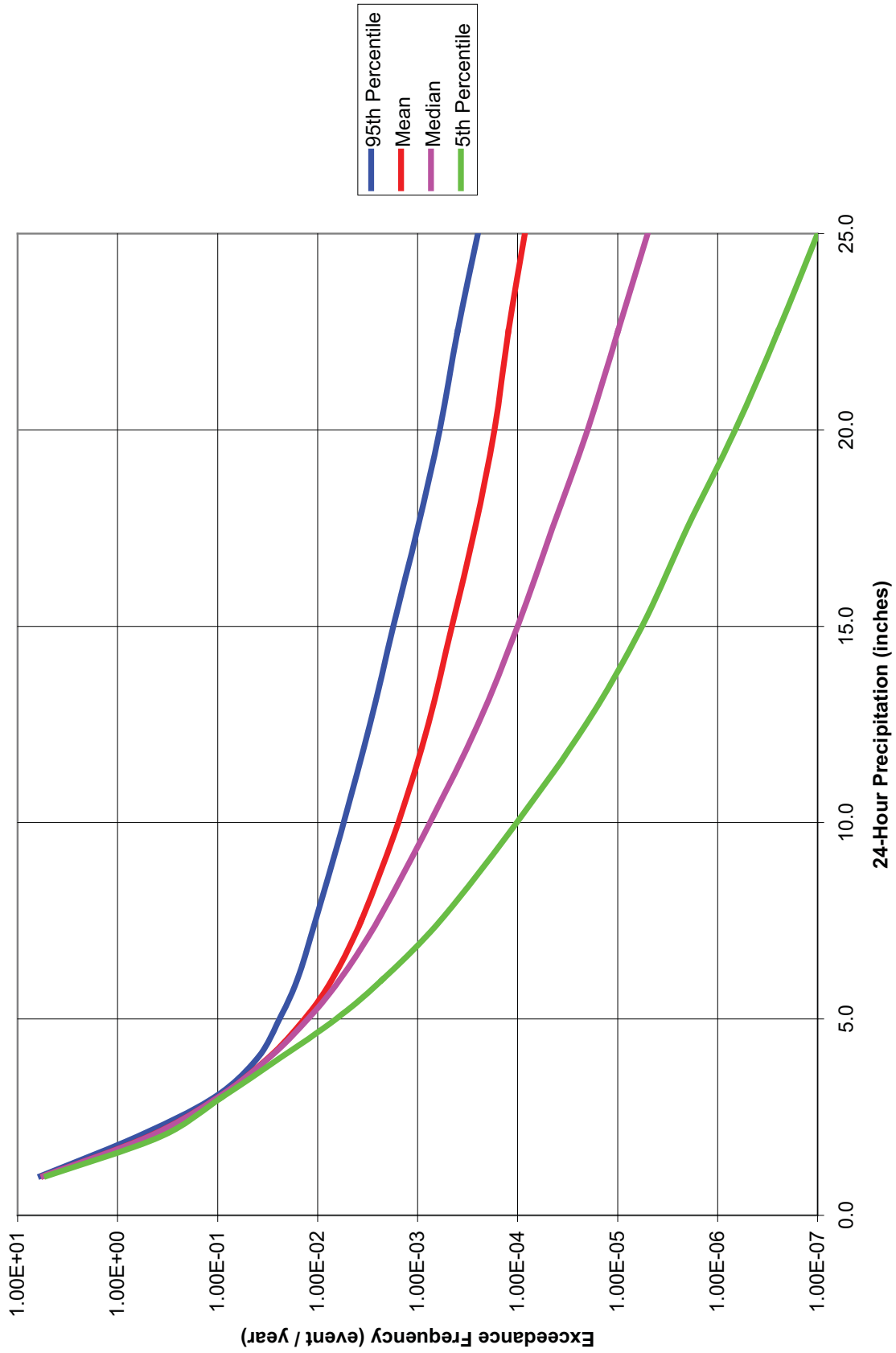

Figure 5.2-11. 24-Hour Precipitation Composite Exceedance Curves for SDA Risk Analyses

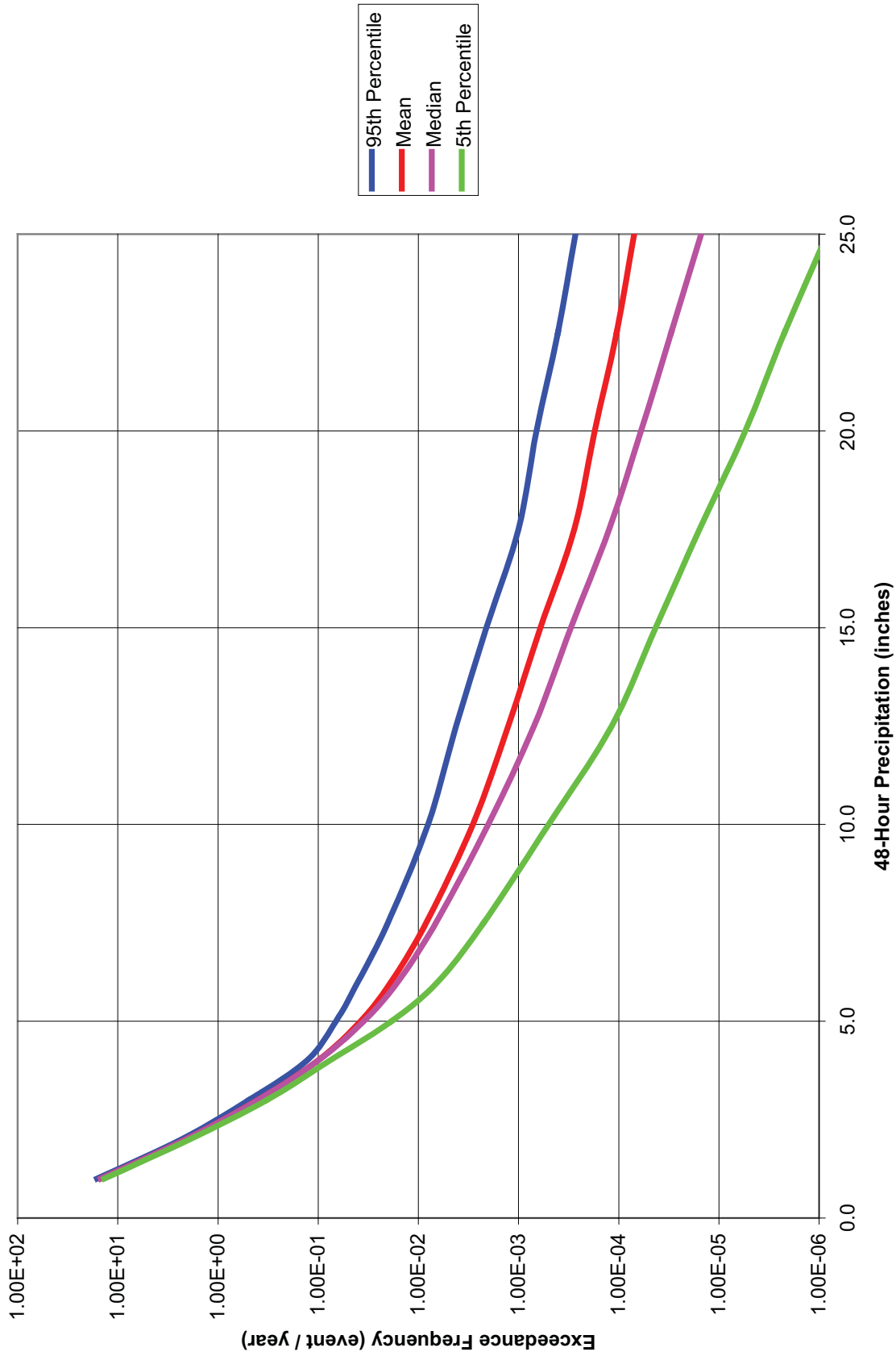

Figure 5.2-12. 48-Hour Precipitation Composite Exceedance Curves for SDA Risk Analyses

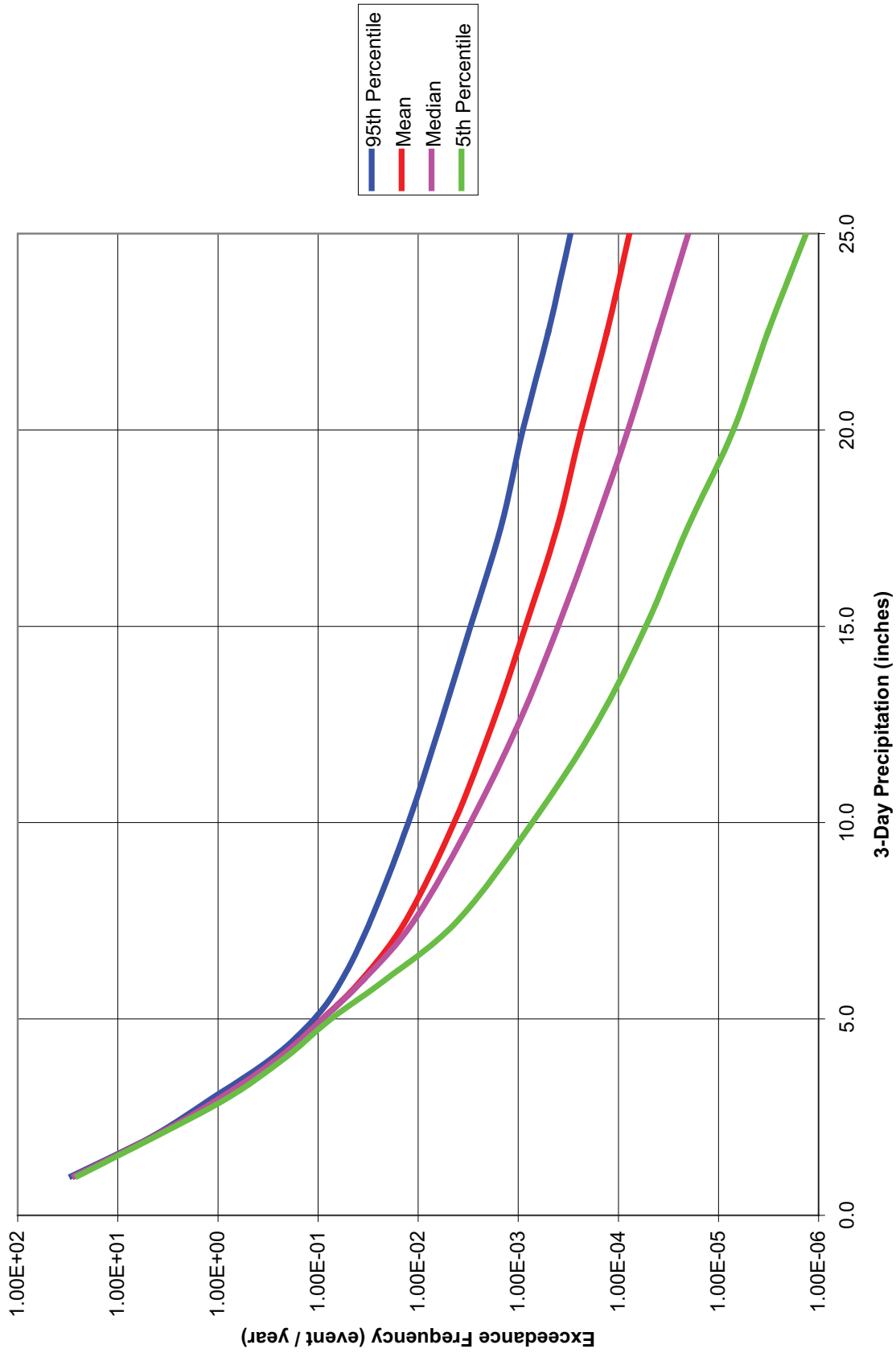

Figure 5.2-13. 3-Day Precipitation Composite Exceedance Curves for SDA Risk Analyses

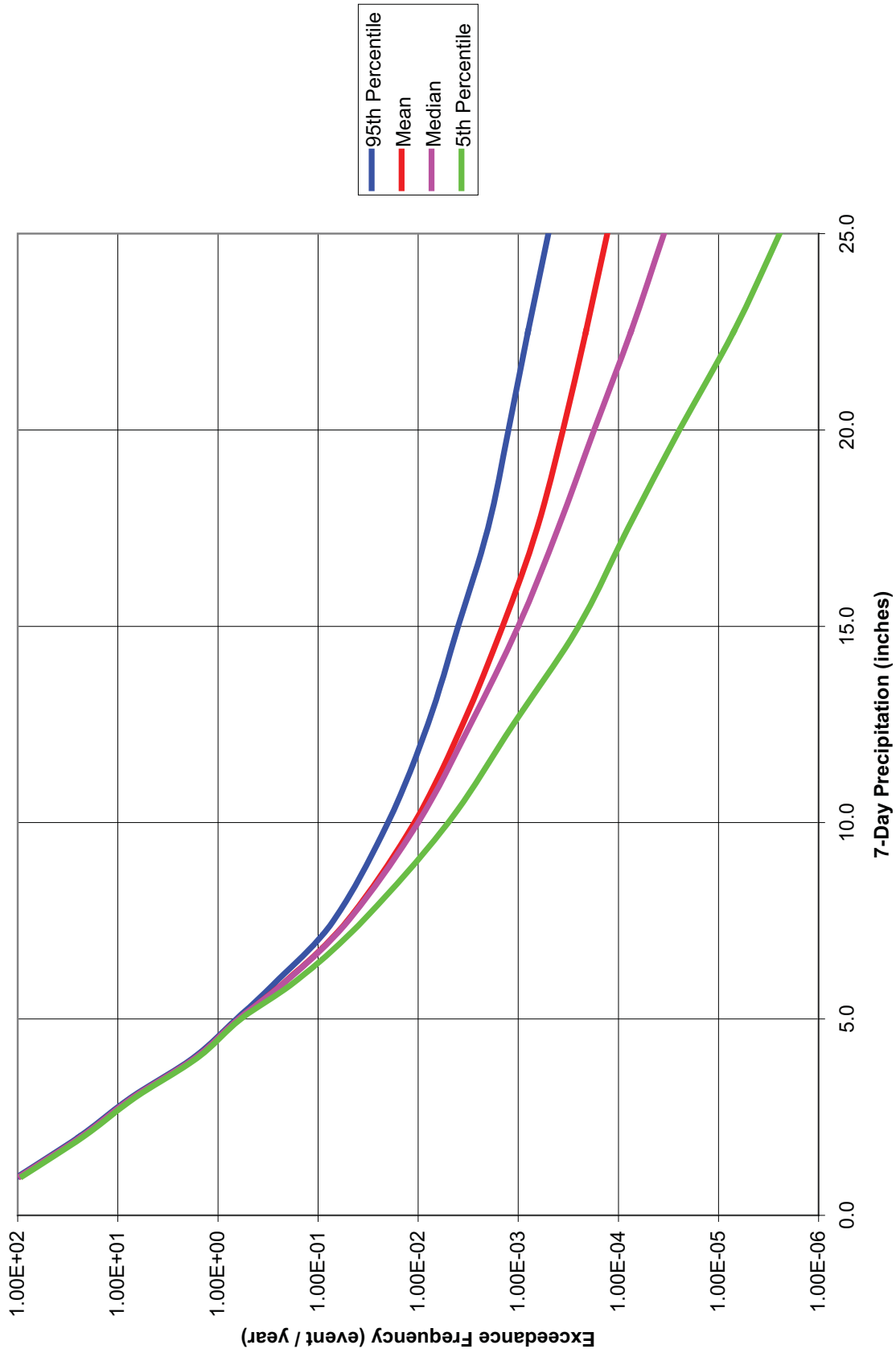

Figure 5.2-14. 7-Day Precipitation Composite Exceedance Curves for SDA Risk Analyses

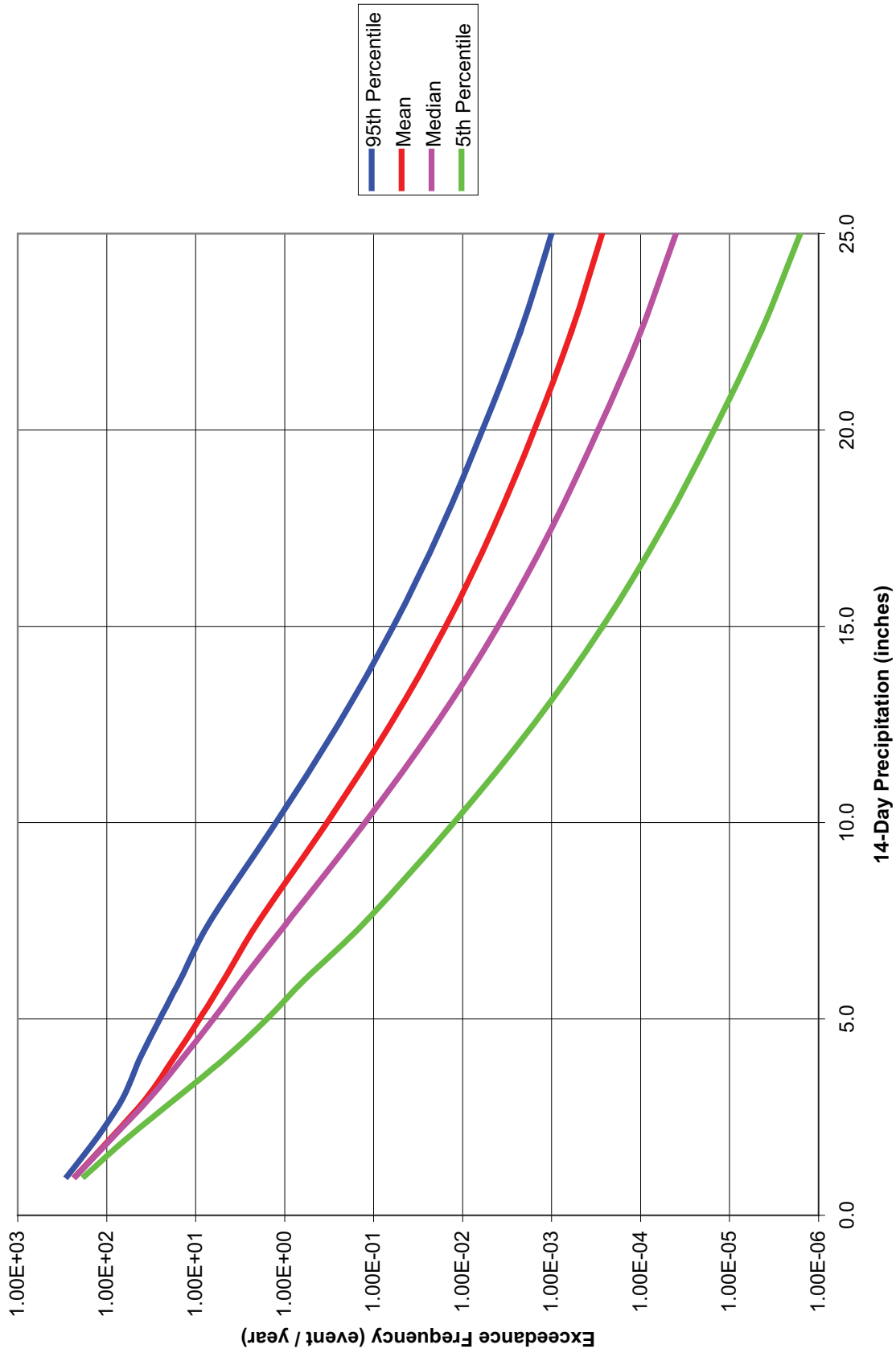

Figure 5.2-15. 14-Day Precipitation Composite Exceedance Curves for SDA Risk Analyses

5.3 HIGH WINDS

This section describes the derivation of exceedance frequencies for high winds (sometimes called straight-line winds) at the West Valley site. Section 5.4 describes the analyses that were performed to evaluate the frequency of tornadoes that may strike the SDA.

5.3.1 Data Sources

Section 5.2.1 summarizes the meteorological data that were used for this study. Regional data were compiled from National Weather Service reporting stations at Buffalo, Dunkirk, and Jamestown (Reference 5.3-1). Data were also collected from the West Valley site meteorological tower (Reference 5.3-2).

5.3.1.1 Regional Weather Data

Each daily weather record from the regional reporting stations contains the following wind data.

- High wind speed (mph)
- Average wind speed (mph)
- High gust wind speed (mph)

The raw data were edited to remove the following records.

- **Sustained wind speed data.** Most of the early year records contain only temperature and precipitation data. These records do not contain any wind speed data. Therefore, they were removed from the database that was used for the analysis of maximum sustained wind speeds. Most of the Dunkirk records do not contain wind speed data.

The affected records are summarized below.

Station	Total Raw Daily Weather Records	Records with No Wind Speed Data	Records Retained for Sustained Wind Analyses
Buffalo	30, 573	8,004	22,569
Dunkirk	28,631	23,011	5,620
Jamestown	11,110	783	10,327

- **Wind gust data.** Maximum wind gust speeds are reported starting in 1973 at Buffalo, 1996 at Dunkirk, and 1973 at Jamestown. Therefore, records before these dates were removed from the database that was used for the analysis of wind gust speeds.

The affected records are summarized below.

Station	Total Raw Daily Weather Records	Records with No Wind Gust Data	Records Retained for Wind Gust Analyses
Buffalo	30, 573	17,815	12,758
Dunkirk	28,631	24,687	3,944
Jamestown	11,110	807	10,303

The retained records were also reviewed for errors and obvious anomalies. These reviews resulted in the following modifications to the raw data.

- **Sustained wind speed data.** Some maximum sustained wind speed data entries are questionable (e.g., wind speeds of more than 125 mph). All daily weather records for Buffalo and Dunkirk with maximum sustained wind speeds of 45 mph or more were reexamined to confirm the validity of the recorded entries. Daily weather records with maximum sustained wind speeds of 40 mph or more were reexamined for Jamestown. Hourly weather records were used to correct erroneous values.
- **Wind gust data.** All daily weather records with wind gust speeds of 60 mph or more for Buffalo, 55 mph or more for Dunkirk, and 50 mph or more for Jamestown were reexamined to confirm the validity of the recorded entries. Hourly weather records were used to correct erroneous values.

The detailed raw data records are retained in the project files, with annotations that document all edited values. However, due to their very large volume, they are not reproduced in this report.

5.3.1.2 West Valley Site Weather Data

Data from the West Valley site meteorological tower were available for the period from January 1, 1991, through December 31, 2007. These data included only the maximum hourly wind speeds for each year at the 10-meter and 60-meter elevations.

Data from the regional reporting stations include both maximum sustained wind speeds and maximum wind gust speeds. The available meteorological records do not indicate the elevations at which these measurements are recorded.

The West Valley data were compared with the regional data over the same time period to determine whether any significant site-specific differences exist.

Comparisons of West Valley and Regional Wind Speed Data ⁽¹⁾ , 1991 – 2007				
West Valley (10-meter)	West Valley (60-meter)	Buffalo	Dunkirk ⁽²⁾	Jamestown
28.83	40.09	51	45	46
Notes:				
(1) Data are maximum sustained wind speeds in miles per hour				
(2) Dunkirk wind speed data from 12/11/1996 – 12/31/2007				

From these comparisons, it is evident that the maximum recorded wind speeds at West Valley were lower than those at the three regional weather stations. This difference may be due to the local topography at the West Valley site. However, it is also not known whether the maximum hourly wind speeds recorded at West Valley are directly comparable to the high wind speeds reported from the regional weather stations (e.g., whether the wind speed measurement times and recording algorithms are consistent).

The West Valley wind speed data are readily available in a format that reports only one maximum hourly value for each year. The regional weather station data include daily maximum sustained wind speeds and peak gust speeds. Therefore, despite the differences from the 17-year comparison, it was concluded that the more detailed and comprehensive regional data are appropriate for development of long-term high wind exceedance frequencies. The QRA project team acknowledges that the regional data may provide conservative estimates for the exceedance frequencies at the West Valley site.

5.3.2 Extrapolation of Historic Experience

According to Section 4.2.1 of the WVDP Safety Analysis Report (Reference 5.3-3), the design-basis straight-line wind loading for important structures is based on a sustained wind speed of 90 mph, with a gust response factor increase to 115 mph. According to Section 4.2.2 of the Safety Analysis Report, the design-basis tornado wind loading for the site is based on a maximum wind speed of 160 mph, with a rotational speed of 110 mph.

Table 5.3-1 compares the historic experience for the maximum hourly sustained wind speeds and the maximum gust speeds at West Valley, Buffalo, Dunkirk, and Jamestown. To estimate the frequencies of very severe wind events that may damage the SDA geomembrane covers and affect releases from the trenches, it was necessary to extrapolate this experience to conditions that are substantially beyond those observed in more than 65 years of data for the surrounding region.

The high wind exceedance curves were derived from the maximum wind gust speeds at the three regional reporting stations. Gust speeds are typically higher than sustained wind speeds, which are reported at hourly intervals. Experience has also shown that damage is often initiated by strong wind gusts during severe storms. Therefore, it was concluded that the wind gust data provide a better estimate of the high wind damage threat than the hourly maximum wind speed data. The historical records indicate that wind gust speeds are not reported as consistently as hourly maximum wind speeds. Therefore, on days for which no wind gust data were reported, the maximum hourly wind speed was used for the analyses.

Figure 5.3-1 plots the wind speed exceedance frequencies for Buffalo, Dunkirk, and Jamestown, based on the available historic data. These curves were produced by sorting the raw data for wind gust speeds and computing the annual frequency of events that exceed each respective value. The raw data plots were then smoothed to remove anomalies from sparse evidence at high speeds. (Discrete transitions between singular storms produce irregularities when the data are plotted in the exceedance curve format. These irregularities were smoothed by interpolating between the observed data points.) The smoothing process retained the historical frequencies for the maximum observed winds speeds at each reporting station, to preserve these end-point anchors for the data extrapolations.

Comparison of the curves shows that Buffalo has the highest recorded wind speed and the highest exceedance frequencies. The historical experience from Dunkirk is very similar to that of Buffalo for wind speeds up to approximately 30 mph. However, the Dunkirk exceedance frequencies are somewhat lower at higher speeds. The Jamestown exceedance frequencies are consistently lower than those at Buffalo and Dunkirk.

The exceedance frequency data from Buffalo, Dunkirk, and Jamestown were next extrapolated to a maximum wind speed of 160 mph (i.e., the West Valley maximum design speed). As noted in Table 5.3-1, the maximum recorded wind speed at any station was 74 mph at Buffalo. The database contains only three entries with wind speeds that exceed 70 mph (all at Buffalo). The Buffalo data contain 40 entries with wind speeds of 60 mph or more, the Dunkirk data contain four entries with wind speeds that exceed 60 mph, and the Jamestown data contain only two entries that exceed 60 mph. Therefore, extrapolation of the historic exceedance curves to very high wind speeds is, at best, an approximate process. The extrapolated curves exhibit increasing divergence at higher wind speeds, as a result of the variability in the reported experience from the three stations. This behavior is typical, and it provides a measure of the uncertainty in the estimated exceedance frequencies. Figure 5.3-2 shows the extrapolated curves.

5.3.3 Composite High Wind Exceedance Curves

The high wind exceedance frequencies for this study are derived from composite uncertainty distributions that account for the historic experience and the extrapolated projections for each reporting station. The Jamestown wind speed data were used as the best estimate (median) for the composite exceedance curves. More extensive historical data are available from Buffalo. However, Jamestown and West Valley are located at similar distances inland from Lake Erie, and the historical comparisons indicate that the near-lake sites may consistently experience higher winds. The ranges of wind speed data from Buffalo and Dunkirk were used as input to the uncertainty analyses.

Lognormal uncertainty distributions were fit to the extrapolated curves to develop estimates of the exceedance frequency over the range of wind speeds. These distributions preserve the median estimates from Jamestown. The Buffalo estimates were used as the 95th percentile of the uncertainty distribution. The resulting lognormal error factors capture the Buffalo and Dunkirk estimates within the 90% confidence interval.

Figure 5.3-3 shows the resulting high wind exceedance curves that are used in the SDA risk analyses. Table 5.3-2 lists the parameter values that were used to develop the curves.

The estimated frequencies for wind speeds in excess of approximately 120 mph are extremely small, and the uncertainties are quite broad. The magnitude and range of these estimates are influenced by the very sparse historical data for wind speeds in excess of 70 mph, and the approximate nature of the extrapolation process. The very low frequencies for severe straight-line winds indicate that other phenomena (e.g., tornadoes) are likely to be more important sources of very high wind speeds at the site.

5.3.4 References

5.3-1. www.wunderground.com

5.3-2. E-mail communication, P. J. Bembia, NYSERDA, and C. M. Bohan, DOE, to J. W. Stetkar, June 5, 2008

5.3-3. "West Valley Demonstration Project, Safety Analysis Report for Waste Processing and Support Activities", WVNS-SAR-001, Revision 11, West Valley Nuclear Services Company, June 2007

Table 5.3-1. Historic Maximum Wind Speeds

Wind Condition	West Valley ⁽¹⁾		Buffalo		Dunkirk		Jamestown	
	Speed (mph)	Date	Speed (mph)	Date	Speed (mph)	Date	Speed (mph)	Date
Sustained	40	1996	59	February 16, 1967	45	November 19, 2003	46	December 12, 2000
Gust	--	--	74	April 6, 1985	64	December 12, 2000	63	December 12, 2000

Notes:

(1) Measured at 60-meter elevation; data available only for maximum hourly wind speed per year

Database Periods:

West Valley: January 1, 1991 – December 31, 2007

Buffalo: Sustained winds: February 1, 1942 – April 30, 2008

Gusts: January 1, 1973 – April 30, 2008

Dunkirk: Sustained winds: February 1, 1949 – April 30, 2008

Gusts: December 11, 1996 – April 30, 2008

Jamestown: Sustained winds: January 1, 1973 – April 30, 2008

Gusts: January 1, 1973 – April 30, 2008

Table 5.3-2. Parameters for SDA QRA High Wind Exceedance Curves

Maximum Wind Speed (mph)	Exceedance Frequency (event / year)				
	5th Percentile	Median	Mean	95th Percentile	Error Factor
40	1.35E+00	6.00E+00	9.07E+00	2.67E+01	4.46
45	2.90E-01	1.95E+00	3.81E+00	1.31E+01	6.72
50	8.43E-02	7.00E-01	1.60E+00	5.81E+00	8.30
55	2.13E-02	2.25E-01	6.28E-01	2.38E+00	10.56
60	6.29E-03	7.09E-02	2.10E-01	8.00E-01	11.28
65	1.55E-03	2.00E-02	6.69E-02	2.58E-01	12.88
70	4.19E-04	6.00E-03	2.22E-02	8.59E-02	14.31
75	1.02E-04	1.75E-03	7.78E-03	3.00E-02	17.14
80	2.50E-05	5.00E-04	2.62E-03	1.00E-02	20.00
90	2.50E-06	5.00E-05	2.62E-04	1.00E-03	20.00
100	2.27E-07	5.00E-06	2.92E-05	1.10E-04	22.00
110	1.92E-08	5.00E-07	3.55E-06	1.30E-05	26.00
120	1.67E-09	5.00E-08	4.24E-07	1.50E-06	30.00
130	1.43E-10	5.00E-09	5.17E-08	1.75E-07	35.00
140	1.25E-11	5.00E-10	6.18E-09	2.00E-08	40.00
150	1.11E-12	5.00E-11	7.27E-10	2.25E-09	45.00
160	1.00E-13	5.00E-12	8.45E-11	2.50E-10	50.00

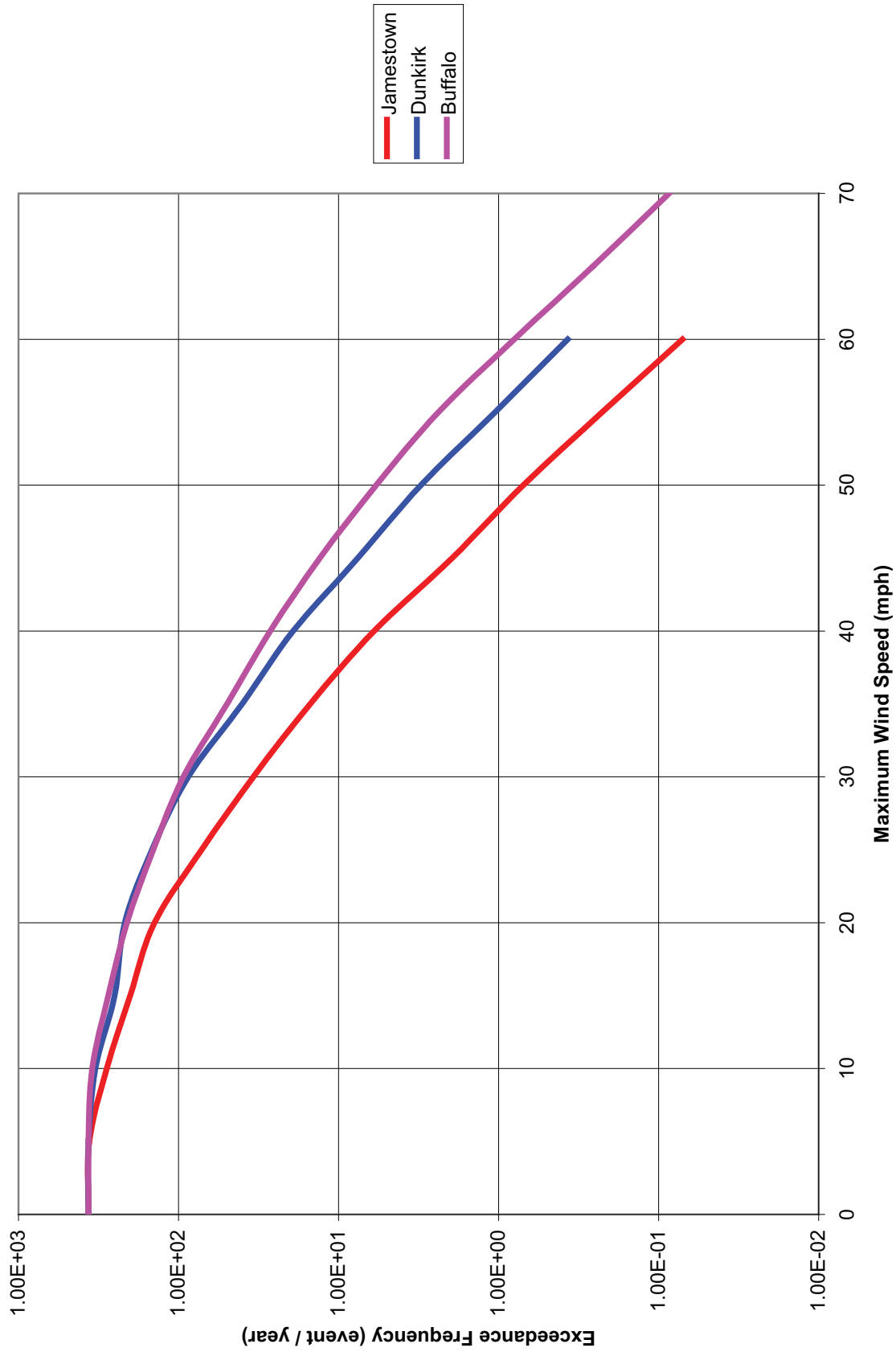

Figure 5.3-1. High Wind Exceedance Curves, Historical Data

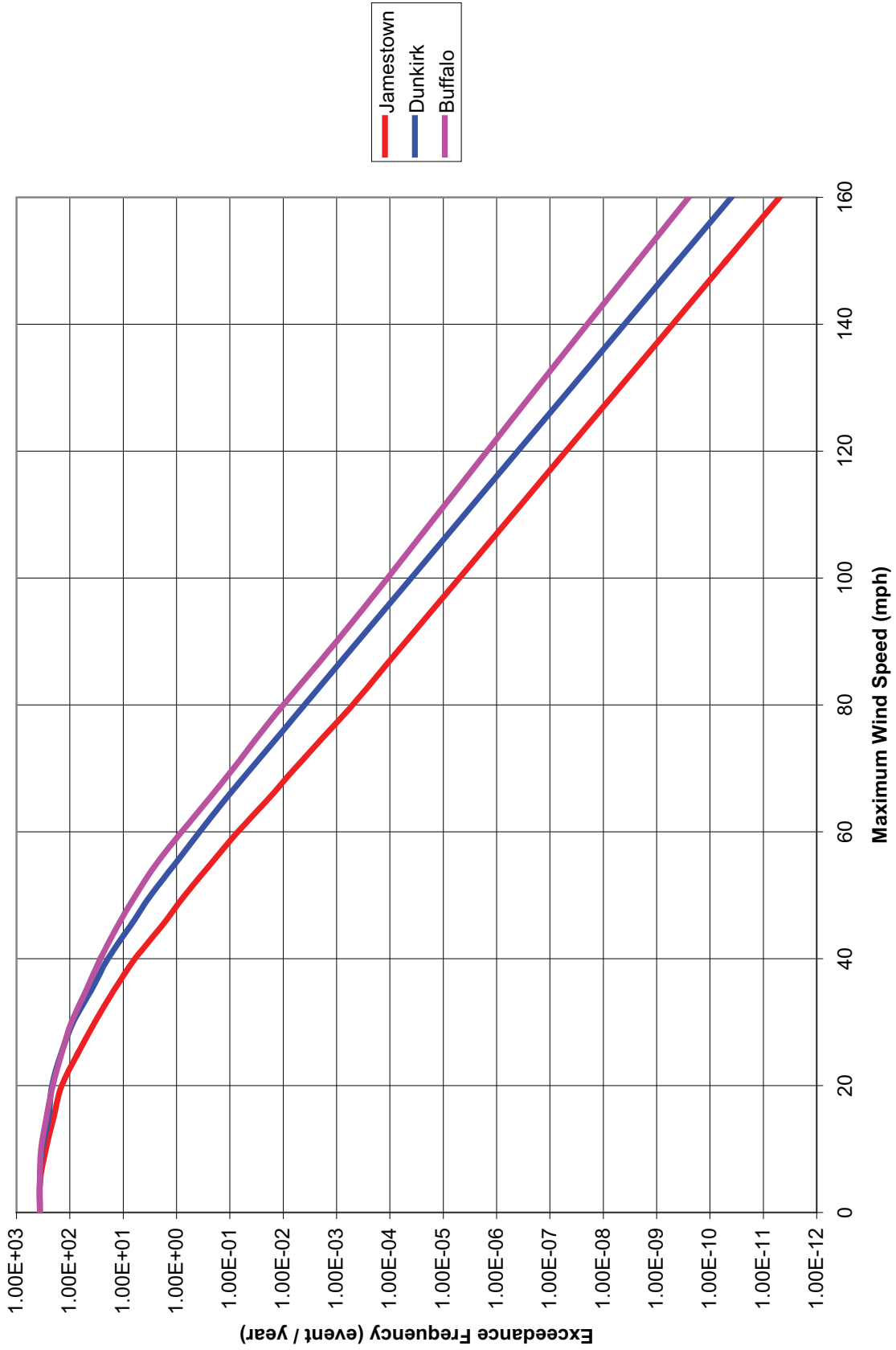

Figure 5.3-2. High Wind Exceedance Curves, Extrapolated

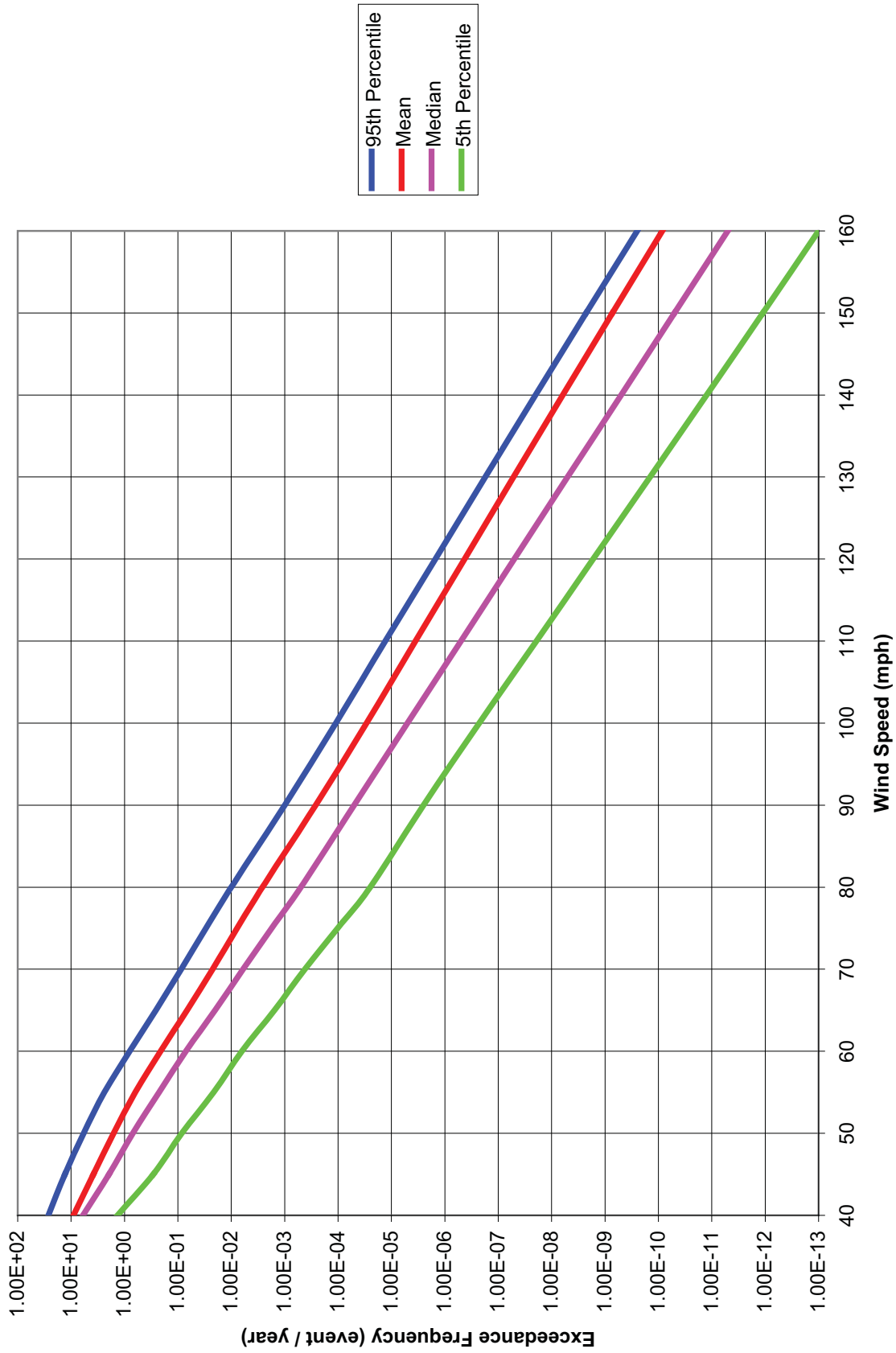

Figure 5.3-3. High Wind Composite Exceedance Curves for SDA Risk Analyses

5.4 TORNADOES

The historical tornado experience for a 50-mile radius surrounding the West Valley site was compiled from References 5.4-1 and 5.4-2. The database covers the time period between January 1, 1950, and December 31, 2006, for tornadoes in western New York and northwest Pennsylvania, and the time period between January 1, 1950, and December 31, 2003, for tornadoes in southern Ontario.

The U.S. tornado records contain the following data.

- Date
- Fujita intensity
- Touchdown location (latitude and longitude)
- Liftoff location (latitude and longitude)
- Path length
- Path width

The Ontario tornado records do not contain information about the path length or width.

The experience includes a total of 109 tornadoes with intensities that range from F0 through F4 on the Fujita scale. Table 5.4-1 summarizes these events. Table 5.4-2 lists the range of wind speeds for each Fujita intensity.

The following factors affect the frequency at which a tornado of a specific intensity may impact the SDA site.

- The frequency of a tornado touchdown per unit area (e.g., event / year–mi²)
- The tornado damage area (e.g., mi²)
- The SDA site area (e.g., mi²)

5.4.1 Tornado Touchdown Frequency

Bayesian analyses were performed to quantify the touchdown frequency per unit area for each tornado intensity.

A prior distribution for the touchdown frequency of tornadoes of any intensity was broadly based on the summary information in Section 3.7.1 of the West Valley Draft Environmental Impact Statement (EIS) (Reference 5.4-3). In that section, it is noted that "the probability of a tornado striking a 2.6-square kilometer (1-square mile) section of the Center was estimated to occur once every 10,000 years".

The following lognormal uncertainty distribution was used to represent this prior state of knowledge.

Prior Distribution for Tornado Touchdown Frequency per Unit Area (events per year per square mile)				
5th Percentile	Median	95th Percentile	Mean	Error Factor
1.0E-06	3.2E-05	1.0E-03	2.9E-04	31.6

The estimated frequency in the EIS is approximately midway between the median value and the mean value of this distribution. The distribution is quite broad. However, it appropriately accounts for the large uncertainties that apply over the full range of tornado intensities that may occur in the region surrounding the site.

The Bayesian analyses updated this prior state of knowledge with the historical experience for tornadoes of each intensity rating. This experience covers the 57-year interval from 1950 through 2006 for the 50-mile radius surrounding the West Valley site (i.e., a total exposure area of 7,854 square miles).

Table 5.4-3 summarizes the updated touchdown frequency distributions for each tornado intensity.

5.4.2 Tornado Damage Area

The geomembrane-covered area of the SDA trenches is approximately 13 acres, or approximately 2.03E-02 square miles (Reference 5.4-4).

The analyses must account for the range of damage areas for each tornado intensity. Two conditions apply for the analysis.

Condition 1: Damage Area ≤ Site Area

If the tornado damage area is less than, or equal to, the SDA site area, the frequency of tornadoes that touch down within the SDA site area is given by:

$$F = N * S$$

where:

F = SDA impact frequency for tornado of intensity "X" (event / year)

N = Tornado intensity "X" touchdown frequency per unit area (event / year-mi²)

S = SDA site area (mi²)

Condition 2: Damage Area > Site Area

If the tornado damage area is greater than the site area, the analysis must account for the fact that a tornado may touch down at some distance from the SDA site and pass through the SDA area.

The historical experience indicates that tornadoes in this region typically track in a westerly to easterly direction. Therefore, the SDA is most vulnerable to damage from tornadoes that touch down to the west of the site.

This analysis conservatively assumes that the SDA may be affected by any tornado that touches down within a radius of the site that is determined by the tornado damage path length. This assumption may overestimate the frequency of damaging tornadoes, because it assumes that tornadoes that touch down to the east of the site may move in a westerly direction. However, this assumption substantially simplifies the analysis, because it is not necessary to perform detailed directional analyses of the historical tornado data. It also accounts for possible rare tornadoes that may meander or approach the site from the east. If this assumption significantly affects the overall SDA site risk, the analyses may be further refined to account for the relative location of the tornado touchdown.

In this analysis, the potential tornado impact area (A) is determined by a circle centered on the SDA site with a radius that is equal to the tornado damage path length. It is assumed that any tornado that touches down within this area may reach the SDA site. However, only a fraction of the tornadoes that touch down within this area will actually affect the site. That fraction is determined by the ratio of the actual tornado damage area (D) to the potential impact area (A).

Thus, the frequency of a tornado that may affect the SDA site is given by:

$$F = (N * A) * (D / A) = N * D$$

where:

F = SDA impact frequency for tornado of intensity "X" (event / year)

N = Tornado intensity "X" touchdown frequency per unit area (event / year-mi²)

A = Tornado intensity "X" potential impact area, defined by damage path length (mi²)

D = Tornado intensity "X" damage area (mi²)

The historical experience shows that there is substantial variability in the reported path lengths and damage areas for each tornado intensity. This experience was used to develop the distributions for the effective SDA impact area that are summarized in Tables 5.4-4 through 5.4-8. For tornado events where the reported damage area (D) was less than the SDA site area (S), the SDA site area (2.03E-02 mi²) applies for the tornado impact frequency analysis. The assigned fraction for this impact area is the cumulative fraction of all events with $D \leq S$. For tornado events where the reported damage area (D) was greater than the SDA site area (S), the actual damage area and its associated fraction apply for the tornado impact frequency analysis.

5.4.3 Frequency of Tornado Impacts at SDA Site

The frequency of tornadoes of each intensity that may impact the SDA site was determined by multiplying the touchdown frequency per unit area by the effective impact area. For example, the frequency of F0 tornadoes that may impact the SDA site was determined by multiplying the F0 touchdown frequency distribution from Table 5.4-3 by the effective impact area distribution

from Table 5.4-4. In these analyses, the F4 tornado effective impact areas in Table 5.4-8 were also used for F5 tornadoes.

The resulting tornado impact frequencies are summarized in Table 5.4-9.

Table 5.4-3 shows that the tornado touchdown frequency per square mile decreases as the tornado intensities increase from F1 to F5. This is consistent with the historical experience that very severe tornadoes generally occur much less often than less damaging tornadoes. However, Table 5.4-9 shows that the mean frequency of tornadoes that impact the SDA site actually increases over the intensity range from F1 to F4. These results occur because the effective tornado damage areas increase significantly as a function of the tornado intensity. Therefore, the overall results contain increasing contributions from tornadoes that touch down at some distance from the site and reach the site before they dissipate.

5.4.4 References

- 5.4-1. www.tornadohistoryproject.com (U.S. tornado reports)
- 5.4-2. <http://ontario.hazards.ca> (Ontario tornado reports)
- 5.4-3. "Draft Environmental Impact Statement for Decommissioning and/or Long-Term Stewardship at the West Valley Demonstration Project and Western New York Nuclear Service Center", January 2008
- 5.4-4. E-mail communication, M. R. Weishan, NYSERDA, to J. W. Stetkar, June 2, 2008

Table 5.4-1. Tornado Events in 50-Mile Radius of West Valley Site, 1950 - 2006

Date	Location	Intensity				Length (miles)	Width (feet)	Damage Area (sq. mi.)	Notes	Ref.
		F0	F1	F2	F3					
7/19/1952	Beaver Dam, PA			x		5.6	80	8.48E-02	Path: 41.93N, 79.75W - 41.92N, 79.63W	1
6/12/1954	Keating Summit, PA			x		0.2	200	7.58E-03	Touchdown: 41.68N, 78.18W	1
4/25/1957	Depew, NY		x			0.5	50	4.73E-03	Touchdown: 42.90N, 78.70W	1
6/12/1959	Jamestown, NY	x				0.1	30	5.68E-04	Touchdown: 42.10N, 79.27W	1
7/6/1959	St. Catharines, ONT	x							Touchdown: 43.20N, 79.24W	2
5/22/1960	Walkleys Landing, NY	x				0.5	450	4.26E-02	Touchdown: 42.70N, 77.70W	1
2/3/1961	Fort Erie, ONT	x							Touchdown: 42.93N, 78.93W	2
5/15/1961	Vandalia, NY				x	3.0	30	1.70E-02	Path: 42.10N, 78.60W - 42.10N, 78.52W	1
6/1/1961	Sherkston, ONT		x						Touchdown: 42.89N, 79.14W	2
7/7/1961	Grandyle Village, NY			x		7.8	300	4.43E-01	Path: 43.00N, 78.95W - 43.00N, 78.78W	1
7/31/1961	Corry, PA		x			0.3	30	1.70E-03	Touchdown: 41.92N, 79.63W	1
6/14/1962	Coudersport, PA			x		0.2	30	1.14E-03	Touchdown: 41.77N, 78.02W	1
7/2/1963	Long View, NY		x			1.3	30	7.39E-03	Path: 42.12N, 79.42W - 42.13N, 79.37W	1
9/3/1963	Lockport Junction, NY		x			0.1	30	5.68E-04	Touchdown: 43.15N, 78.75W	1
9/3/1963	Ridgway, PA				x	8.4	300	4.77E-01	Path: 41.42N, 78.73W - 41.45N, 78.57W	1
5/16/1965	Panama, NY			x		0.1	2100	3.98E-02	Path: 42.10N, 79.50W - 42.10N, 79.45W	1
7/7/1965	Java Village, NY		x			1.0	1800	3.41E-01	Touchdown: 42.65N, 78.45W	1
8/17/1965	Machias, NY	x				0.1	900	1.70E-02	Touchdown: 42.42N, 78.50W	1
9/9/1965	Hartfield, NY		x			0.3	300	1.70E-02	Touchdown: 42.27N, 79.47W	1
6/9/1966	Holland, NY	x				1.0	100	1.89E-02	Touchdown: 42.63N, 78.55W	1
7/24/1967	Ashford Hollow, NY				x	11.4	750	1.62E+00	Path: 42.42N, 78.67W - 42.33N, 78.47W	1
8/6/1968	Wango, NY			x		31.8	750	4.52E+00	Path: 42.40N, 79.08W - 42.23N, 78.50W	1
5/17/1969	Sinclairville, NY			x		2.0	750	2.84E-01	Touchdown: 42.27N, 79.27W	1
6/20/1969	Clymer, NY				x	84.1	30	4.78E-01	Path: 42.02N, 79.63W - 42.32N, 78.05W	1
7/26/1969	Bergholtz, NY		x			2.0	300	1.14E-01	Touchdown: 43.10N, 78.92W	1
6/11/1970	St. Catharines, ONT	x							Touchdown: 43.18N, 79.29W	2

Table 5.4-1. Tornado Events in 50-Mile Radius of West Valley Site, 1950 - 2006

Date	Location	Intensity					Length (miles)	Width (feet)	Damage Area (sq. mi.)	Notes	Ref.
		F0	F1	F2	F3	F4					
7/15/1970	Chautauqua Lake, NY		x				0.5	30	2.84E-03	Touchdown: 42.17N, 79.40W	1
7/15/1970	Pittsfield, PA		x				1.0	500	9.47E-02	Touchdown: 41.83N, 79.38W	1
8/19/1970	Eden, NY				x		2.3	900	3.92E-01	Path: 42.67N, 78.88W - 42.67N, 78.82W	1
6/2/1971	Edinboro, PA				x		29.3	30	1.66E-01	Path: 41.87N, 80.13W - 41.93N, 79.57W	1
8/23/1971	Depew, NY			x			0.1	500	9.47E-03	Path: 42.92N, 78.70W - 42.93N, 78.65W	1
5/2/1972	Colegrave, NY			x			12.0	1050	2.39E+00	Path: 42.73N, 78.52W - 42.78N, 78.28W	1
7/28/1973	Oswayo, PA		x				0.1	30	5.68E-04	Touchdown: 41.92N, 78.03W	1
4/3/1974	Frewsburg, NY		x				0.2	150	5.68E-03	Touchdown: 42.05N, 79.17W	1
7/29/1974	Coudersport, PA		x				0.4	60	4.55E-03	Touchdown: 41.80N, 78.03W	1
2/24/1975	Humphrey, NY		x				0.5	300	2.84E-02	Touchdown: 42.17N, 78.50W	1
6/5/1975	Lake Machias, NY	x					0.5	50	4.73E-03	Touchdown: 42.40N, 78.52W	1
6/30/1976	Harris Hill, NY		x				0.3	90	5.11E-03	Touchdown: 42.97N, 78.70W	1
6/30/1976	Silver Creek, NY		x				0.1	30	5.68E-04	Touchdown: 42.55N, 79.17W	1
8/8/1977	West Lincoln, ONT			x						Touchdown: 43.12N, 79.54W	2
9/18/1977	Gowanda, NY		x				11.7	300	6.65E-01	Path: 42.45N, 78.92W - 42.43N, 78.68W	1
6/12/1978	Niagara-on-the-Lake, ONT	x								Touchdown: 43.25N, 79.12W	2
7/26/1978	Stevensville, ONT	x								Touchdown: 42.94N, 79.05W	2
9/3/1978	Welland, ONT	x								Touchdown: 42.97N, 79.25W	2
10/5/1978	Welland, ONT	x								Touchdown: 42.97N, 79.24W	2
4/2/1979	Spartansburg, PA		x				0.1	30	5.68E-04	Touchdown: 41.83N, 79.70W	1
4/6/1979	Brockport, NY	x					14.0	30	7.95E-02	Path: 43.22N, 77.95W - 43.23N, 77.67W	1
6/29/1980	Ellicottville, NY		x				10.1	120	2.30E-01	Path: 42.27N, 78.67W - 42.20N, 78.48W	1
8/11/1981	Queenston, ONT	x								Touchdown: 43.19N, 79.08W	2
9/8/1981	Rush, NY		x				2.0	300	1.14E-01	Touchdown: 43.00N, 77.65W	1
7/28/1982	Elmhurst, NY		x				3.0	750	4.26E-01	Path: 42.12N, 79.30W - 42.10N, 79.23W	1
7/28/1982	Sheridan, NY	x					0.2	150	5.68E-03	Touchdown: 42.28N, 79.23W	1

Table 5.4-1. Tornado Events in 50-Mile Radius of West Valley Site, 1950 - 2006

Date	Location	Intensity				Length (miles)	Width (feet)	Damage Area (sq. mi.)	Notes	Ref.	
		F0	F1	F2	F3						F4
5/2/1983	Sherman, NY				x		28.0	1350	7.16E+00	Path: 42.15N, 79.62W - 42.32N, 79.08W	1
5/3/1985	Chaffee, PA			x			19.0	900	3.24E+00	Path: 41.57N, 78.95W - 41.67N, 78.65W	1
5/31/1985	Cherry Run, PA					x	29.0	3000	1.65E+01	Path: 41.63N, 79.03W - 41.55N, 78.50W	1
5/31/1985	Pittsfield, PA		x				5.0	390	3.69E-01	Path: 41.80N, 79.38W - 41.82N, 79.28W	1
5/31/1985	Stillwater, NY				x		13.0	530	1.30E+00	Path: 42.03N, 79.23W - 42.13N, 79.15W	1
5/31/1985	Tidioute, PA				x		17.0	2400	7.73E+00	Path: 41.68N, 79.48W - 41.65N, 79.15W	1
5/31/1985	Waterford, PA					x	28.0	1320	7.00E+00	Path: 41.93N, 79.95W - 42.05N, 79.43W	1
6/22/1985	Youngsville, PA		x				3.0	50	2.84E-02	Path: 41.85N, 79.33W - 41.83N, 79.27W	1
9/29/1986	Lyndonville, NY		x				0.5	70	6.63E-03	Touchdown: 43.35N, 78.40W	1
7/30/1987	Buffalo, NY			x			1.5	90	2.56E-02	Touchdown: 42.92N, 78.77W	1
7/19/1989	Bemus Point, NY	x					0.1	30	5.68E-04	Touchdown: 42.17N, 79.38W	1
8/28/1990	Allegany State Park, NY	x					0.5	180	1.70E-02	Touchdown: 42.02N, 78.83W	1
8/28/1990	Jamestown, NY	x					4.0	300	2.27E-01	Path: 42.15N, 79.22W - 42.15N, 79.10W	1
4/9/1991	Forestville, NY	x					0.5	30	2.84E-03	Touchdown: 42.47N, 79.17W	1
4/9/1991	Libertypole, NY		x				0.5	90	8.52E-03	Touchdown: 42.63N, 77.62W	1
4/9/1991	Springville, NY		x				0.5	30	2.84E-03	Touchdown: 42.50N, 78.65W	1
5/1/1991	Eden, NY	x					0.5	30	2.84E-03	Touchdown: 42.65N, 78.88W	1
5/1/1991	Java Center, NY		x				0.2	150	5.68E-03	Touchdown: 42.65N, 78.40W	1
7/12/1992	South Newstead, NY		x				0.5	60	5.68E-03	Touchdown: 42.97N, 78.52W	1
7/17/1992	Franklinville, NY		x				0.5	60	5.68E-03	Touchdown: 42.33N, 78.45W	1
7/11/1993	Arkwright, NY		x				0.5	30	2.84E-03	Touchdown: 42.40N, 79.23W	1
7/26/1993	Kane, PA	x					2.5	600	2.84E-01	Touchdown: 41.67N, 78.83W	1
8/31/1993	Clarence, NY		x				0.8	150	2.27E-02	Touchdown: 42.98N, 78.58W	1
9/3/1993	Angelica, NY			x			3.5	150	9.94E-02	Path: 42.30N, 78.02W - 42.33N, 77.97W	1
9/3/1993	Batavia, NY		x				4.2	190	1.51E-01	Path: 43.00N, 78.18W - 43.05N, 78.12W	1
9/23/1993	North Tonawanda, NY	x					2.0	70	2.65E-02	Touchdown: 43.03N, 78.90W	1

Table 5.4-1. Tornado Events in 50-Mile Radius of West Valley Site, 1950 - 2006

Date	Location	Intensity				Length (miles)	Width (feet)	Damage Area (sq. mi.)	Notes	Ref.
		F0	F1	F2	F3					
6/13/1994	Ellington, NY			x		3.0	100	5.68E-02	Path: 42.22N, 79.10W - 42.22N, 79.05W	1
6/13/1994	Freedom, NY		x			1.0	50	9.47E-03	Touchdown: 42.48N, 78.33W	1
6/24/1994	Angola, NY	x				0.1	30	5.68E-04	Touchdown: 42.63N, 79.03W	1
8/28/1994	Bucyrus Heights, NY	x				0.3	30	1.70E-03	Touchdown: 43.02N, 78.80W	1
8/28/1994	Freedonia, NY		x			2.0	30	1.14E-02	Touchdown: 42.43N, 79.33W	1
8/28/1994	Lockport, NY	x				0.6	30	3.41E-03	Touchdown: 43.17N, 78.70W	1
8/28/1994	Truemans, PA		x			2.5	250	1.18E-01	Touchdown: 41.62N, 79.10W	1
9/26/1994	Emporium, PA		x			4.0	300	2.27E-01	Path: 41.50N, 78.13W - 41.50N, 78.05W	1
7/30/1996	Canaseraga, NY	x				0.5	30	2.84E-03	Touchdown: 42.47N, 77.78W	1
7/8/1997	Stannards, NY	x				0.2	40	1.52E-03	Touchdown: 42.08N, 77.93W	1
7/18/1997	Wharton, PA	x				2.0	300	1.14E-01	Touchdown: 41.53N, 78.02W	1
9/25/1997	Angola, NY	x				0.2	30	1.14E-03	Touchdown: 42.65N, 79.03W	1
5/31/1998	Brocton, NY		x			2.0	90	3.41E-02	Touchdown: 42.38N, 79.43W	1
5/31/1998	Dunnville, ONT		x						Touchdown: 42.91N, 79.61W	2
5/31/1998	Johnsonburg, PA		x			3.0	300	1.70E-01	Touchdown: 41.48N, 78.68W	1
5/31/1998	Ridgway, PA	x				0.5	300	2.84E-02	Touchdown: 41.43N, 78.75W	1
6/2/1998	Custer City, PA		x			8.0	1320	2.00E+00	Touchdown: 41.90N, 78.67W	1
6/2/1998	Orangeville Center, NY			x		15.0	750	2.13E+00	Path: 42.75N, 78.25W - 42.63N, 78.05W	1
7/9/1999	Tidioute, PA		x			3.0	300	1.70E-01	Path: 41.68N, 79.42W - 41.68N, 79.37W	1
8/19/2001	Parrish, PA		x			5.0	300	2.84E-01	Path: 41.50N, 79.02W - 41.57N, 78.87W	1
9/25/2001	Lowbanks, ONT	x							Touchdown: 42.87N, 79.39W	2
4/28/2002	Belfast, NY			x		6.5	300	3.69E-01	Path: 42.33N, 78.12W - 42.30N, 78.02W	1
4/28/2002	Footes, NY	x				0.7	20	2.65E-03	Touchdown: 42.55N, 78.63W	1
7/28/2002	Pittsfield, PA		x			3.0	100	5.68E-02	Path: 41.83N, 79.40W - 41.88N, 79.40W	1
8/22/2002	Wellsville, NY		x			4.0	150	1.14E-01	Touchdown: 42.17N, 77.98W	1
7/21/2003	Ellisburg, PA				x	2.5	200	9.47E-02	Touchdown: 41.92N, 77.93W	1

Date	Location	Intensity				Length (miles)	Width (feet)	Damage Area (sq. mi.)	Notes	Ref.
		F0	F1	F2	F3					
7/21/2003	Mt. Alton, PA		x			5.5	600	6.25E-01	Touchdown: 41.77N, 78.62W	1
6/17/2004	Truemans, PA		x			2.5	100	4.73E-02	Touchdown: 41.65N, 79.10W	1
8/12/2005	Canistota, NY		x			1.0	200	3.79E-02	Touchdown: 42.27N, 77.60W	1
8/12/2005	Wellsville, NY	x				0.5	10	9.47E-04	Touchdown: 42.17N, 77.95W	1
6/30/2006	Buffalo, NY		x			3.0	70	3.98E-02	Touchdown: 42.92N, 78.77W	1

Table 5.4-2. Fujita Tornado Intensity Scale	
Intensity	Wind Speed (mph)
F0	40 – 72
F1	73 – 112
F2	113 – 157
F3	158 – 206
F4	207 – 260
F5	261 – 318

Table 5.4-3. Bayesian Analysis Results for Tornado Touchdown Frequency per Unit Area

Fujita Intensity	Observed Events	Updated Touchdown Frequency (event / year-mi ²)			
		5th Percentile	Median	Mean	95th Percentile
F0	33	5.0E-05	6.8E-05	7.3E-05	9.0E-05
F1	48	7.7E-05	9.9E-05	1.1E-04	1.3E-04
F2	16	2.1E-05	3.3E-05	3.6E-05	4.8E-05
F3	10	1.2E-05	2.0E-05	2.3E-05	3.3E-05
F4	2	1.3E-06	4.5E-06	5.5E-06	1.1E-05
F5	0	1.3E-07	1.1E-06	1.8E-06	4.9E-06

Table 5.4-4. Distribution for Tornado Intensity F0 Effective Impact Area				
Tornado Experience			SDA Impact Analysis	
Reported Events	Damage Area (mi²)	Fraction of Tornadoes	Impact Area (mi²)	Fraction of Tornadoes
3	5.68E-04	0.125		
1	9.47E-04	0.042		
1	1.14E-03	0.042		
1	1.52E-03	0.042		
1	1.70E-03	0.042		
1	2.65E-03	0.042		
3	2.84E-03	0.125		
1	3.41E-03	0.042		
1	4.73E-03	0.042		
1	5.68E-03	0.042		
2	1.70E-02	0.083		
1	1.89E-02	0.042	2.03E-02	0.708
1	2.65E-02	0.042	2.65E-02	0.042
1	2.84E-02	0.042	2.84E-02	0.042
1	4.26E-02	0.042	4.26E-02	0.042
1	7.95E-02	0.042	7.95E-02	0.042
1	1.14E-01	0.042	1.14E-01	0.042
1	2.27E-01	0.042	2.27E-01	0.042
1	2.84E-01	0.042	2.84E-01	0.042

Tornado Experience			SDA Impact Analysis	
Reported Events	Damage Area (mi²)	Fraction of Tornadoes	Impact Area (mi²)	Fraction of Tornadoes
4	5.68E-04	0.087		
1	1.70E-03	0.022		
3	2.84E-03	0.065		
1	4.55E-03	0.022		
1	4.73E-03	0.022		
1	5.11E-03	0.022		
4	5.68E-03	0.087		
1	6.63E-03	0.022		
1	7.39E-03	0.022		
1	8.52E-03	0.022		
1	9.47E-03	0.022		
1	1.14E-02	0.022		
1	1.70E-02	0.022	2.03E-02	0.457
1	2.27E-02	0.022	2.27E-02	0.022
2	2.84E-02	0.043	2.84E-02	0.043
1	3.41E-02	0.022	3.41E-02	0.022
1	3.79E-02	0.022	3.79E-02	0.022
1	3.98E-02	0.022	3.98E-02	0.022
1	4.73E-02	0.022	4.73E-02	0.022
1	5.68E-02	0.022	5.68E-02	0.022
1	9.47E-02	0.022	9.47E-02	0.022
3	1.14E-01	0.065	1.14E-01	0.065
1	1.18E-01	0.022	1.18E-01	0.022
1	1.51E-01	0.022	1.51E-01	0.022
2	1.70E-01	0.043	1.70E-01	0.043
1	2.27E-01	0.022	2.27E-01	0.022

Table 5.4-5. Distribution for Tornado Intensity F1 Effective Impact Area

Tornado Experience			SDA Impact Analysis	
Reported Events	Damage Area (mi ²)	Fraction of Tornadoes	Impact Area (mi ²)	Fraction of Tornadoes
1	2.30E-01	0.022	2.30E-01	0.022
1	2.84E-01	0.022	2.84E-01	0.022
1	3.41E-01	0.022	3.41E-01	0.022
1	3.69E-01	0.022	3.69E-01	0.022
1	4.26E-01	0.022	4.26E-01	0.022
1	6.25E-01	0.022	6.25E-01	0.022
1	6.65E-01	0.022	6.65E-01	0.022
1	2.00	0.022	2.00	0.022

Tornado Experience			SDA Impact Analysis	
Reported Events	Damage Area (mi²)	Fraction of Tornadoes	Impact Area (mi²)	Fraction of Tornadoes
1	1.14E-03	0.067		
1	7.58E-03	0.067		
1	9.47E-03	0.067	2.03E-02	0.200
1	2.56E-02	0.067	2.56E-02	0.067
1	3.98E-02	0.067	3.98E-02	0.067
1	5.68E-02	0.067	5.68E-02	0.067
1	8.48E-02	0.067	8.48E-02	0.067
1	9.94E-02	0.067	9.94E-02	0.067
1	2.84E-01	0.067	2.84E-01	0.067
1	3.69E-01	0.067	3.69E-01	0.067
1	4.43E-01	0.067	4.43E-01	0.067
1	2.13	0.067	2.13	0.067
1	2.39	0.067	2.39	0.067
1	3.24	0.067	3.24	0.067
1	4.52	0.067	4.52	0.067

Table 5.4-7. Distribution for Tornado Intensity F3 Effective Impact Area				
Tornado Experience			SDA Impact Analysis	
Reported Events	Damage Area (mi²)	Fraction of Tornadoes	Impact Area (mi²)	Fraction of Tornadoes
1	1.70E-02	0.100	2.03E-02	0.100
1	9.47E-02	0.100	9.47E-02	0.100
1	1.66E-01	0.100	1.66E-01	0.100
1	3.92E-01	0.100	3.92E-01	0.100
1	4.77E-01	0.100	4.77E-01	0.100
1	4.78E-01	0.100	4.78E-01	0.100
1	1.30	0.100	1.30	0.100
1	1.62	0.100	1.62	0.100
1	7.16	0.100	7.16	0.100
1	7.73	0.100	7.73	0.100

Table 5.4-8. Distribution for Tornado Intensity F4 Effective Impact Area				
Tornado Experience			SDA Impact Analysis	
Reported Events	Damage Area (mi²)	Fraction of Tornadoes	Impact Area (mi²)	Fraction of Tornadoes
1	7.00	0.500	7.00	0.500
1	16.5	0.500	16.5	0.500

Table 5.4-9. SDA Tornado Impact Frequencies				
Fujita Intensity	Frequency (event / year)			
	5th Percentile	Median	Mean	95th Percentile
F0	1.15E-06	1.54E-06	3.50E-06	1.69E-05
F1	1.74E-06	3.01E-06	1.62E-05	6.47E-05
F2	5.72E-07	3.74E-06	3.26E-05	1.43E-04
F3	4.15E-07	1.12E-05	4.39E-05	1.93E-04
F4	1.19E-05	4.94E-05	6.45E-05	1.54E-04
F5	1.29E-06	1.23E-05	2.06E-05	6.60E-05

5.5 SEISMIC HAZARD

A consistent probabilistic evaluation of the site-specific seismic hazard is required for quantification of the frequency and consequences from earthquakes that may initiate a broad range of potential ground motions at the West Valley site.

5.5.1 Available Hazard Analyses

Two probabilistic seismic hazard analyses for the West Valley site are documented in the references that were available for this project.

The first analysis was performed in 1992 by Dames & Moore (Reference 5.5-1). The results are summarized in Volume II of the West Valley Environmental Information Document (Reference 5.5-2). The hazard analyses were performed according to the methodology and guidelines developed by the Electric Power Research Institute (EPRI) Seismicity Owners Group (SOG). The published results from that study are limited by a maximum evaluated peak ground acceleration (pga) of 0.20 g. The results include a full evaluation of the uncertainties in the seismic hazard over the pga range from 0.025 g to 0.20 g.

An updated analysis was performed in 2004 by URS Corporation (Reference 5.5-3). The updated analyses accounted for additional seismic sources not considered in the 1992 study, lessons learned from applications of the EPRI/SOG methodology, and improved information about the site-specific soils response. The published results from that study are limited by a maximum evaluated pga of 0.30 g and a minimum exceedance frequency of 1.0E-05 event per year (i.e., a 100,000-year return period). The results include a full evaluation of the uncertainties in the seismic hazard within these bounds.

The project team contacted the authors of the 2004 URS study to investigate whether additional analyses were performed for pga values that exceed 0.30 g. The URS analysts provided data for the mean exceedance frequencies for accelerations up to 1.5 g, developed consistently with the published results. However, they noted that quantitative uncertainty analyses were available only for the results below 0.30 g.

The United States Geological Survey (USGS) publishes seismic hazard maps that cover all regions of the country. The most recent update to these maps was completed in 2008 (Reference 5.5-4). One of the USGS grid points is located near the West Valley site (42.45N, 78.65W). The USGS analyses cover a pga range from 0.005 g to 2.13 g. However, the published results document only the mean exceedance frequencies over this range, with no evaluation of the uncertainties.

The project team also conferred with Dr. Klaus H. Jacob of Columbia University. His suggestions and experience provided useful insights for understanding the general nature of the seismic hazard at Eastern United States sites, such as West Valley.

In summary, the following seismic hazard information was used as input for the project analyses.

- Probabilistic seismic hazard curves from the 2004 URS study, including uncertainties, over the pga range from 0.01 g to 0.30 g

- Mean exceedance frequency curve from the 2004 URS study, with no uncertainty, over the pga range from 0.30 g to 1.5 g
- Mean exceedance frequency curve from the 2008 USGS seismic hazard maps, with no uncertainty, over the pga range from 0.005 g to 2.13 g

5.5.2 Evaluation of Uncertainties and Extrapolation of Hazard Curves

The available information summarized in Section 5.5.1 does not provide a complete characterization of the seismic hazard over the full range of accelerations that may be important to the SDA site risk. This characterization requires a consistent evaluation of the uncertainties over the full range of accelerations up to approximately 2.0 g. It also requires explicit consideration of the disparate results from the URS and USGS analyses, especially at high pga values.

5.5.2.1 URS Seismic Hazard Curves

The 2004 URS seismic hazard analysis results (Figure 17 in Reference 5.5-3) plot the mean hazard curve and the 5th, 15th, 50th, 85th, and 95th probability percentiles of the underlying uncertainty distributions over a pga range from 0.01 g to 0.30 g. The 5th percentile and 15th percentile curves are truncated where they drop below an exceedance frequency of 1.0E-05 event per year.

Uncertainties for the URS seismic hazard were quantified according to the following process.

1. The URS mean hazard curve was retained as the "anchor" for the uncertainty analyses. This curve, supplemented by the additional data provided by the study authors, spans the range of accelerations from 0.01 g to 1.5 g.
2. Lognormal uncertainty distributions were fit to the published results between 0.01 g and 0.30 g. Lognormal error factors (or, equivalently, standard deviations) were selected to best fit the range between the 5th and the 95th probability percentiles of the published hazard curves at each pga value.
3. The lognormal error factors were progressively increased for pga values that extend beyond 0.30 g. The progression accounts for the observed increases in uncertainty over the range of the published results. It also accounts for the experience from numerous other probabilistic seismic hazard analyses that show large uncertainties in the estimated exceedance frequencies for very high accelerations.

The lognormal distributions fit the published results quite well over the range from 0.01 g to 0.30 g. This provides confidence that the lognormal function reasonably captures the shape and the range of uncertainties that were evaluated by the URS analysts, and the lognormal model is appropriate for extrapolation beyond the range of the published curves.

After the full set of URS hazard curves were developed to the limit of the mean exceedance frequency data, the curves were then extrapolated to cover the remaining pga range from 1.5 g to 2.0 g. This extrapolation was performed by a simple curve fitting process. Although the extrapolated range is relatively large on a linear acceleration scale (i.e., extension by 0.5 g), the curves are well-defined on a logarithmic scale, and the extrapolation process is relatively

straightforward. Figure 5.5-1 shows the full set of extrapolated URS hazard curves. Table 5.5-1 lists the parameter values that were used to develop the curves.

5.5.2.2 USGS Seismic Hazard Curves

Only the mean hazard curve is available from the 2008 USGS analysis results. Comparisons were made among the 1992 Dames & Moore analyses, the 2004 URS analyses, and probabilistic seismic hazard analyses performed for commercial nuclear power plant risk assessments. Those comparisons indicated that the general ranges of uncertainty displayed in the 2004 URS results are rather typical for evaluations of seismic hazards in the Eastern United States. Therefore, the following process was used to assign uncertainties around the USGS mean hazard curve.

- (1) The USGS mean hazard curve was retained as the "anchor" for the uncertainty analyses. This curve spans a range of accelerations from 0.005 g to 2.13 g.
- (2) Lognormal uncertainty distributions were fit to the published results. The lognormal error factors derived from the URS analyses were applied to the USGS mean curve at each respective pga value.

Thus, the range and the shape of the uncertainty distributions for the USGS results mirror the uncertainties in the URS results. However, the USGS distributions account for the numerical influence from the different mean exceedance frequency estimates. Figure 5.5-2 shows the full set of USGS hazard curves with the assigned uncertainties. Table 5.5-2 lists the parameter values that were used to develop the curves.

5.5.3 Composite Seismic Hazard Curves

Figure 5.5-3 shows the mean hazard curve from the 2004 URS analyses (extrapolated to 2.0 g) and the mean hazard curve from the 2008 USGS analyses. The USGS mean exceedance frequencies are slightly lower than the URS mean frequencies for accelerations below approximately 0.10 g. The USGS mean exceedance frequencies are higher than the URS mean frequencies for accelerations above 0.10 g.

Significant efforts are currently underway to rationalize the seismic hazard data and evaluations for the Central and Eastern United States. Joint studies are being conducted by the USGS, the Nuclear Regulatory Commission, the Department of Energy, and other stakeholders. These studies have yet to reach consensus on the best applicable methods or the conclusions from any specific hazard analyses. However, the following general observations are relevant to this project.

- The 2004 URS hazard analyses contain a detailed evaluation of numerous seismic sources, ground motion models, attenuation models, and specific characteristics of the region surrounding the West Valley site. The analyses were performed using consistent methods to account for variability and uncertainties derived from several expert teams that contributed to the study.
- The 2008 USGS hazard analyses account for updated information about the seismic sources and fault zones. However, they may not rigorously account for uncertainties that

arise from different assumptions and models regarding ground motion and attenuation. Details of the USGS analysis methods were not examined for this project.

- The NRC has recently expressed concerns that analyses performed according to methods similar to those used in the 2004 URS study may underestimate the seismic hazard for many locations in the Central and Eastern United States.

Based on these observations, the project team concluded that it would be inappropriate to select only the URS results or only the USGS results to characterize the seismic hazard for the SDA risk analyses. Therefore, a set of composite hazard curves was developed by probabilistically combining the URS and USGS estimates. In this process, the URS curves shown in Figure 5.5-1 and Table 5.5-1 were assigned a probabilistic weight of 60% that they are the "true" representation of the seismic hazard at West Valley. The USGS curves shown in Figure 5.5-2 and Table 5.5-2 were assigned a weight of 40%. A higher weight was assigned to the URS results because they are clearly derived from a methodology that explicitly accounts for site-specific conditions, and they include a rigorous and explicit quantification of the associated uncertainties. Despite these considerations in favor of the URS study, a relatively high weight was assigned to the USGS results to account for the ongoing efforts to re-evaluate the seismic hazard in the Eastern United States, the NRC concerns with regard to potential underestimations from earlier analyses, and the fact that the USGS estimates are more pessimistic than the URS estimates over the range of accelerations that are likely to contribute to the SDA risk.

The probability-weighted URS results and USGS results were then merged (not added) to preserve their respective uncertainties. Figure 5.5-4 shows the resulting composite seismic hazard curves that are used in the SDA risk analyses. Table 5.5-3 lists the parameter values that were used to develop the curves.

5.5.4 References

- 5.5-1. "Probabilistic Seismic Hazard Analysis, West Valley Demonstration Project", West Valley, New York, unpublished report, Dames & Moore, 1992
- 5.5-2. "Environmental Information Document, Volume II, Seismology", WVDP-EIS-005, Revision 0, West Valley Nuclear Services Company, Inc., December 1992
- 5.5-3. "Seismic Hazard Evaluation for the Western New York Nuclear Service Center, New York", URS Corporation, June 2004
- 5.5-4. http://earthquake.usgs.gov/research/hazmaps/products_data/2008/data

Table 5.5-1. Parameters for Modified URS Seismic Hazard Curves

Peak Ground Acceleration (g)	Exceedance Frequency (event / year)				
	5th Percentile	Median	Mean	95th Percentile	Error Factor
0.01	2.00E-03	6.80E-03	8.97E-03	2.31E-02	3.40
0.02	7.70E-04	2.69E-03	3.60E-03	9.43E-03	3.50
0.04	2.86E-04	1.06E-03	1.45E-03	3.91E-03	3.70
0.05	2.01E-04	7.53E-04	1.04E-03	2.82E-03	3.75
0.06	1.51E-04	5.76E-04	8.00E-04	2.19E-03	3.80
0.08	9.29E-05	3.62E-04	5.10E-04	1.41E-03	3.90
0.10	6.01E-05	2.46E-04	3.56E-04	1.01E-03	4.10
0.12	4.08E-05	1.75E-04	2.60E-04	7.55E-04	4.30
0.14	2.85E-05	1.28E-04	1.95E-04	5.78E-04	4.50
0.15	2.43E-05	1.12E-04	1.72E-04	5.15E-04	4.60
0.16	2.08E-05	9.76E-05	1.52E-04	4.59E-04	4.70
0.18	1.49E-05	7.44E-05	1.20E-04	3.72E-04	5.00
0.20	1.15E-05	5.99E-05	9.90E-05	3.12E-04	5.20
0.22	8.76E-06	4.73E-05	8.00E-05	2.55E-04	5.40
0.24	6.81E-06	3.81E-05	6.60E-05	2.14E-04	5.60
0.26	5.36E-06	3.11E-05	5.50E-05	1.80E-04	5.80
0.28	4.33E-06	2.60E-05	4.70E-05	1.56E-04	6.00
0.30	3.42E-06	2.14E-05	3.98E-05	1.34E-04	6.25
0.40	1.60E-06	1.04E-05	1.99E-05	6.77E-05	6.50
0.50	8.53E-07	5.76E-06	1.13E-05	3.89E-05	6.75
0.60	4.75E-07	3.33E-06	6.70E-06	2.33E-05	7.00
0.70	3.01E-07	2.18E-06	4.50E-06	1.58E-05	7.25
0.75	2.39E-07	1.76E-06	3.70E-06	1.31E-05	7.40
0.80	1.95E-07	1.46E-06	3.10E-06	1.10E-05	7.50
0.90	1.29E-07	1.00E-06	2.17E-06	7.75E-06	7.75
1.00	8.83E-08	7.06E-07	1.57E-06	5.65E-06	8.00

Table 5.5-1. Parameters for Modified URS Seismic Hazard Curves

Peak Ground Acceleration (g)	Exceedance Frequency (event / year)				
	5th Percentile	Median	Mean	95th Percentile	Error Factor
1.25	3.54E-08	3.18E-07	7.77E-07	2.87E-06	9.00
1.50	1.61E-08	1.61E-07	4.29E-07	1.61E-06	10.00
1.75	7.85E-09	8.64E-08	2.50E-07	9.50E-07	11.00
2.00	3.99E-09	4.79E-08	1.50E-07	5.75E-07	12.00

Table 5.5-2. Parameters for Modified USGS Seismic Hazard Curves

Peak Ground Acceleration (g)	Exceedance Frequency (event / year)				
	5th Percentile	Median	Mean	95th Percentile	Error Factor
0.010	1.39E-03	4.74E-03	6.25E-03	1.61E-02	3.40
0.014	9.58E-04	3.31E-03	4.39E-03	1.14E-02	3.45
0.019	6.26E-04	2.19E-03	2.93E-03	7.67E-03	3.50
0.020	5.99E-04	2.10E-03	2.80E-03	7.33E-03	3.50
0.027	3.96E-04	1.43E-03	1.93E-03	5.13E-03	3.60
0.038	2.48E-04	9.18E-04	1.26E-03	3.40E-03	3.70
0.040	2.23E-04	8.24E-04	1.18E-03	3.05E-03	3.70
0.050	1.70E-04	6.37E-04	8.80E-04	2.39E-03	3.75
0.053	1.57E-04	5.90E-04	8.17E-04	2.22E-03	3.77
0.060	1.33E-04	5.04E-04	7.00E-04	1.91E-03	3.80
0.074	9.67E-05	3.74E-04	5.25E-04	1.45E-03	3.87
0.080	8.65E-05	3.37E-04	4.75E-04	1.32E-03	3.90
0.100	5.91E-05	2.42E-04	3.50E-04	9.93E-04	4.10
0.103	5.67E-05	2.33E-04	3.36E-04	9.54E-04	4.10
0.120	4.32E-05	1.86E-04	2.75E-04	7.98E-04	4.30
0.140	3.29E-05	1.48E-04	2.25E-04	6.67E-04	4.50
0.145	3.03E-05	1.38E-04	2.11E-04	6.28E-04	4.55
0.150	2.90E-05	1.33E-04	2.05E-04	6.13E-04	4.60
0.160	2.53E-05	1.19E-04	1.85E-04	5.59E-04	4.70
0.180	1.95E-05	9.73E-05	1.57E-04	4.86E-04	5.00
0.200	1.57E-05	8.17E-05	1.35E-04	4.25E-04	5.20
0.203	1.52E-05	7.93E-05	1.31E-04	4.12E-04	5.20
0.220	1.29E-05	6.98E-05	1.18E-04	3.77E-04	5.40
0.240	1.05E-05	5.89E-05	1.02E-04	3.30E-04	5.60
0.260	8.96E-06	5.20E-05	9.20E-05	3.01E-04	5.80
0.280	7.55E-06	4.53E-05	8.20E-05	2.72E-04	6.00

Table 5.5-2. Parameters for Modified USGS Seismic Hazard Curves

Peak Ground Acceleration (g)	Exceedance Frequency (event / year)				
	5th Percentile	Median	Mean	95th Percentile	Error Factor
0.284	7.28E-06	4.40E-05	8.01E-05	2.66E-04	6.05
0.300	6.28E-06	3.92E-05	7.30E-05	2.45E-04	6.25
0.397	3.82E-06	2.49E-05	4.75E-05	1.62E-04	6.50
0.400	3.73E-06	2.42E-05	4.63E-05	1.58E-04	6.50
0.500	2.45E-06	1.66E-05	3.25E-05	1.12E-04	6.75
0.556	1.96E-06	1.35E-05	2.68E-05	9.27E-05	6.88
0.600	1.65E-06	1.15E-05	2.32E-05	8.07E-05	7.00
0.700	1.18E-06	8.57E-06	1.77E-05	6.21E-05	7.25
0.750	9.80E-07	7.25E-06	1.52E-05	5.37E-05	7.40
0.778	9.11E-07	6.79E-06	1.43E-05	5.06E-05	7.45
0.800	8.50E-07	6.38E-06	1.35E-05	4.78E-05	7.50
0.900	6.24E-07	4.84E-06	1.05E-05	3.75E-05	7.75
1.000	4.78E-07	3.82E-06	8.50E-06	3.06E-05	8.00
1.090	3.61E-07	3.04E-06	7.01E-06	2.55E-05	8.40
1.250	2.32E-07	2.09E-06	5.10E-06	1.88E-05	9.00
1.500	1.20E-07	1.20E-06	3.20E-06	1.20E-05	10.00
1.520	1.13E-07	1.13E-06	3.02E-06	1.13E-05	10.00
1.750	6.28E-08	6.91E-07	2.00E-06	7.60E-06	11.00
2.000	3.33E-08	3.99E-07	1.25E-06	4.79E-06	12.00
2.130	2.36E-08	2.95E-07	9.60E-07	3.69E-06	12.50

Table 5.5-3. Parameters for SDA QRA Composite Seismic Hazard Curves

Peak Ground Acceleration (g)	Exceedance Frequency (event / year)				
	5th Percentile	Median	Mean	95th Percentile	Error Factor
0.01	1.76E-03	5.98E-03	7.88E-03	2.03E-02	3.40
0.02	7.02E-04	2.45E-03	3.28E-03	8.59E-03	3.50
0.04	2.61E-04	9.66E-04	1.34E-03	3.57E-03	3.70
0.05	1.89E-04	7.07E-04	9.76E-04	2.65E-03	3.75
0.06	1.44E-04	5.47E-04	7.60E-04	2.08E-03	3.80
0.08	9.03E-05	3.52E-04	4.96E-04	1.37E-03	3.90
0.10	5.97E-05	2.44E-04	3.54E-04	1.00E-03	4.10
0.12	4.18E-05	1.79E-04	2.66E-04	7.72E-04	4.30
0.14	3.03E-05	1.36E-04	2.07E-04	6.14E-04	4.50
0.15	2.62E-05	1.20E-04	1.85E-04	5.54E-04	4.60
0.16	2.26E-05	1.06E-04	1.65E-04	4.99E-04	4.70
0.18	1.67E-05	8.36E-05	1.35E-04	4.18E-04	5.00
0.20	1.32E-05	6.86E-05	1.13E-04	3.57E-04	5.20
0.22	1.04E-05	5.63E-05	9.52E-05	3.04E-04	5.40
0.24	8.29E-06	4.64E-05	8.04E-05	2.60E-04	5.60
0.26	6.80E-06	3.95E-05	6.98E-05	2.28E-04	5.80
0.28	5.62E-06	3.37E-05	6.10E-05	2.02E-04	6.00
0.30	4.56E-06	2.85E-05	5.31E-05	1.78E-04	6.25
0.40	2.45E-06	1.59E-05	3.05E-05	1.04E-04	6.50
0.50	1.49E-06	1.01E-05	1.98E-05	6.81E-05	6.75
0.60	9.45E-07	6.60E-06	1.33E-05	4.63E-05	7.00
0.70	6.53E-07	4.74E-06	9.78E-06	3.43E-05	7.25
0.75	5.35E-07	3.96E-06	8.30E-06	2.93E-05	7.40
0.80	4.57E-07	3.43E-06	7.26E-06	2.57E-05	7.50
0.90	3.27E-07	2.54E-06	5.50E-06	1.97E-05	7.75
1.00	2.44E-07	1.95E-06	4.34E-06	1.56E-05	8.00

Table 5.5-3. Parameters for SDA QRA Composite Seismic Hazard Curves

Peak Ground Acceleration (g)	Exceedance Frequency (event / year)				
	5th Percentile	Median	Mean	95th Percentile	Error Factor
1.25	1.14E-07	1.03E-06	2.51E-06	9.24E-06	9.00
1.50	5.77E-08	5.77E-07	1.54E-06	5.77E-06	10.00
1.75	2.98E-08	3.28E-07	9.50E-07	3.61E-06	11.00
2.00	1.57E-08	1.88E-07	5.90E-07	2.26E-06	12.00

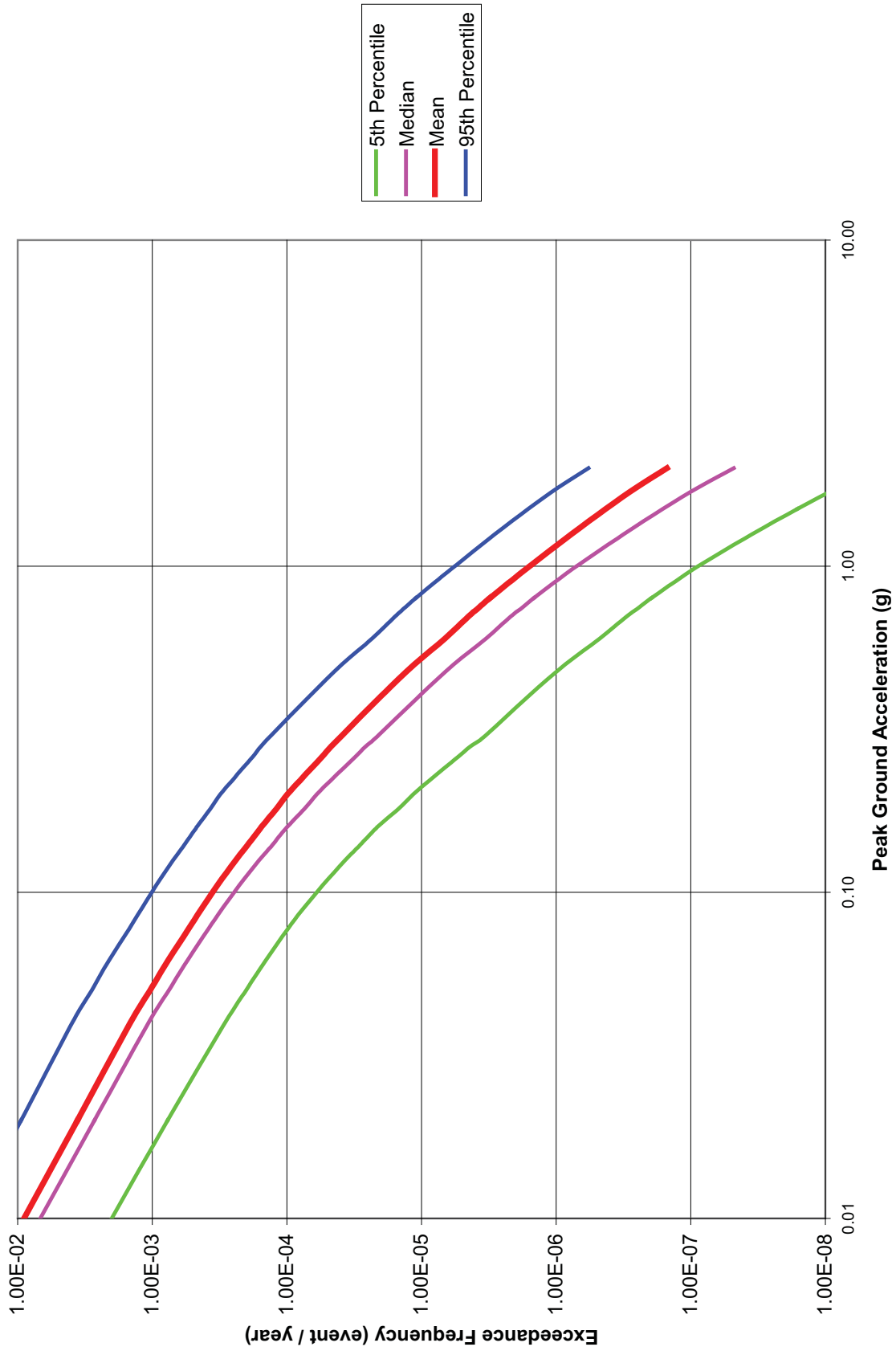

Figure 5.5-1. Modified URS Seismic Hazard Curves

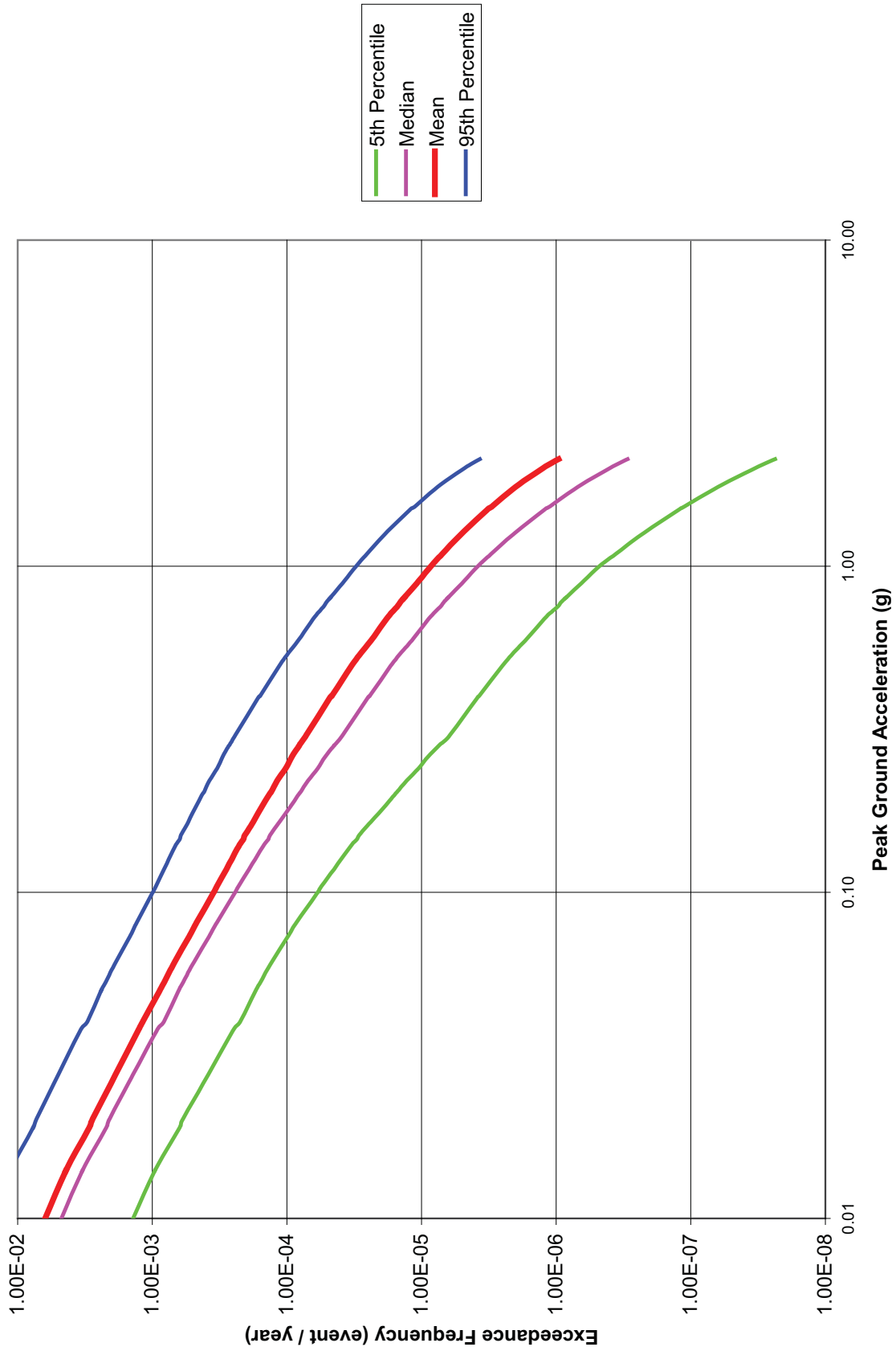

Figure 5.5-2. Modified USGS Seismic Hazard Curves

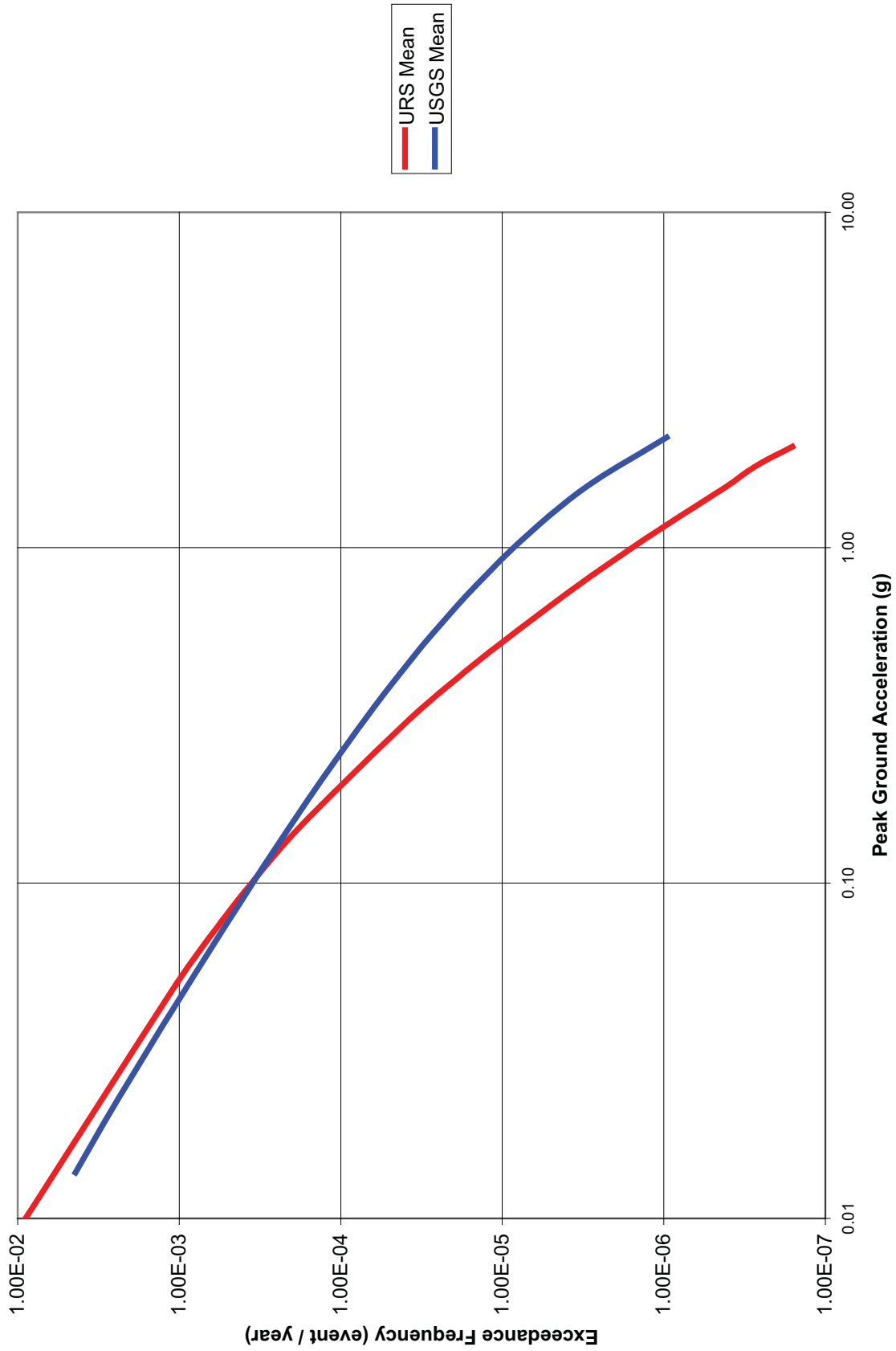

Figure 5.5-3. Comparison of URS and USGS Mean Hazard Curves

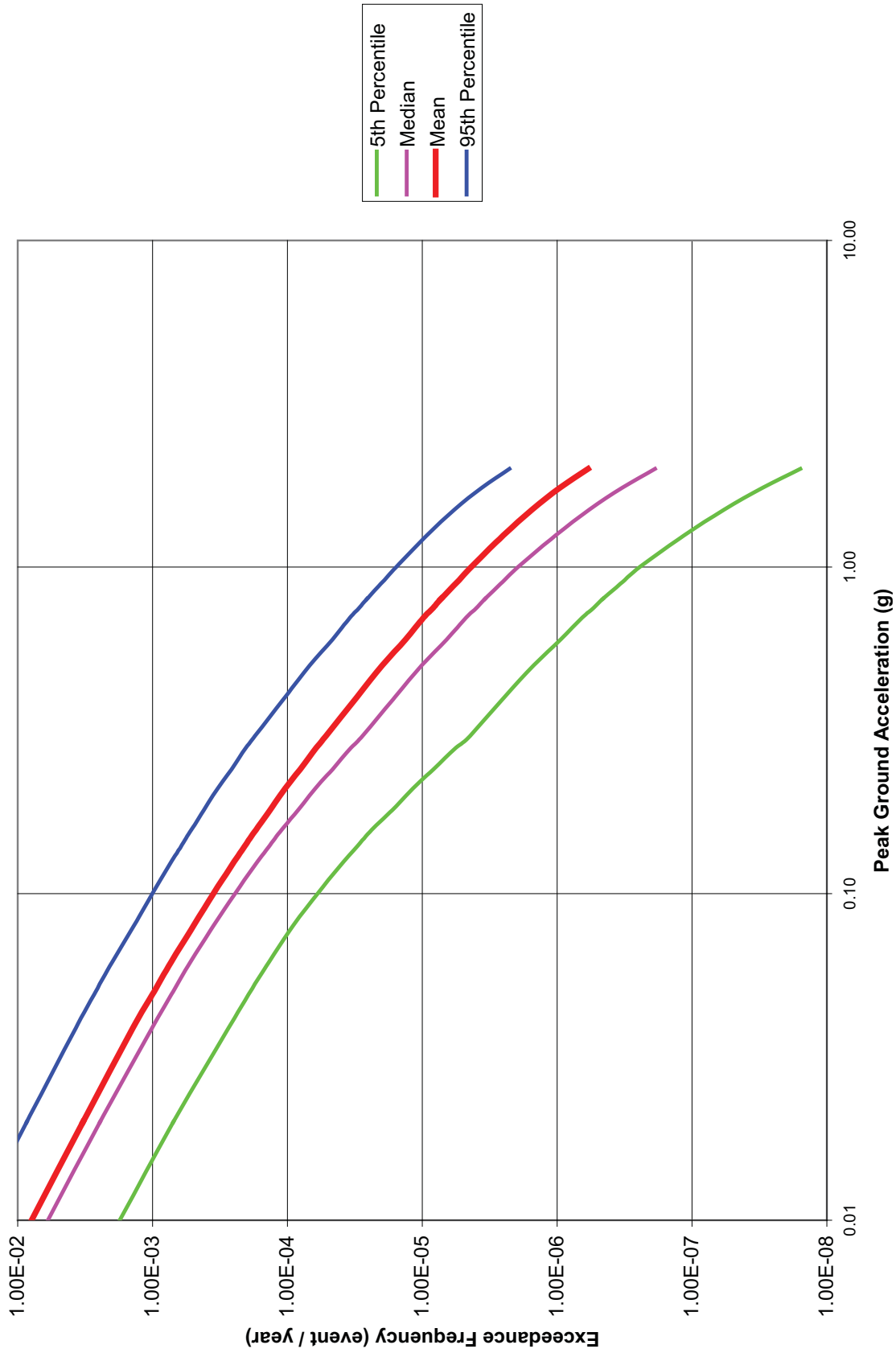

Figure 5.5-4. Composite Seismic Hazard Curves for SDA Risk Analyses

5.6 AIRCRAFT CRASHES

The West Valley site is located approximately 34 miles south of the Buffalo Niagara International Airport. Table 5.6-1 lists several other general aviation airports, small airfields, and one military air base located within a 50-mile radius from the site.

A number of air traffic flight control corridors pass over the area surrounding the site. The closest of these corridors is summarized in Table 5.6-2. Aircraft in the high altitude ("J") corridors typically operate between 18,000 feet and 45,000 feet, under active air traffic control. Aircraft in the low altitude ("V") corridors are limited to a maximum altitude of 18,000 feet, and may be operating under visual flight rules.

5.6.1 Commercial Aircraft Crash Frequency

Aircraft accident statistics for U.S. commercial air carriers from 1983 through 2007 are tabulated by the U.S. National Transportation Safety Board (NTSB) in Reference 5.6-1. The following accident rates were derived from that experience.

Carrier Type	Total Accidents	Accident Rate per Mile Flown	Accident Rate per Flight Hour	Accident Rate per Departure
14CFR121	499	3.40E-09	1.14E-06	2.22E-06
14CFR135 Scheduled	331	4.96E-08	9.48E-06	6.74E-06
14CFR135 On-Demand	2,224	N/A	3.01E-05	N/A

Carriers operating under 14CFR121 include scheduled and unscheduled passenger flights, and scheduled commuter aircraft with 10 or more seats. Scheduled carriers operating under 14CFR135 include scheduled commuter aircraft with fewer than 10 seats, and scheduled cargo flights. On-demand carriers operating under 14CFR135 include charter flights, air taxis, and unscheduled cargo flights. The NTSB data summaries include estimates of only total flight hours for the on-demand carriers.

The accidents for 14CFR121 carriers are classified further as follows.

- Major: Aircraft destroyed, or multiple fatalities, or one fatality and substantial aircraft damage
- Serious: One fatality without substantial aircraft damage, or at least one injury and substantial aircraft damage
- Injury: At least one injury without substantial aircraft damage
- Damage: Substantial aircraft damage without any injuries

The 14CFR121 carrier experience from 1983 through 2007 includes a total of 84 "Major" accidents, 49 "Serious" accidents, 340 "Injury" accidents, and 366 "Damage" accidents. Only the 499 accidents in the "Major", "Serious", and "Damage" categories are included in this analysis. Accidents assigned to the "Injury" category include events such as passenger or crew

injuries due to in-flight turbulence, and other causes for personnel injuries that do not involve significant damage to the aircraft. These types of events are not relevant to the frequency of aircraft crashes that may impact the SDA.

More detailed data and statistical analyses are available in the NTSB annual reports for aircraft operations. For example, the event summaries in References 5.6-2 and 5.6-3 indicate that essentially all of the reported accidents for 14CFR135 carriers involve some amount of damage to the aircraft. Therefore, all accidents for these carriers are included in the analysis of aircraft crashes that may impact the SDA.

The NTSB annual reports also provide information about accident occurrences during nine phases of flight operations, plus a "not reported" classification. The data from 1997 (Reference 5.6-2) and 2003 (Reference 5.6-3) were used to derive the following average fractions.

Phase of Flight Operations	Fraction of Accidents		
	14CFR121 Carriers	14CFR135 Scheduled Carriers	14CFR135 On-Demand Carriers
Parked, Loading, Taxi	0.475	0.111	0.151
Takeoff	0.050	--	0.094
Initial Climb	0.025	0.167	0.069
Climb	0.050	--	0.050
Cruise	0.113	0.111	0.239
Descent	0.088	0.167	0.025
Initial Approach	0.050	0.056	0.126
Final Approach	--	0.167	0.044
Landing	0.100	0.167	0.151
Not Reported	0.050	0.056	0.050

5.6.1.1 Accidents in Vicinity of Buffalo Niagara International Airport

Accidents that occur during the "Parked, Loading, Taxi", "Takeoff", and "Landing" phases of flight operations have potential impacts only in the area immediately surrounding the airport. These accidents are not relevant to the SDA site.

Accidents during the "Initial Climb", "Initial Approach", and "Final Approach" phases of flight operations typically occur at altitudes of approximately 10,000 feet, or lower. An aircraft with a no-power glide ratio of g flying at an elevation h can strike the ground at a distance $g \cdot h$ from the point at which the disabling incident occurs. A glide ratio of 17 is typical for large commercial aircraft. If the disabling incident occurs at an altitude of 10,000 feet and the aircraft maintains a glide ratio of 17, the maximum potential impact distance is approximately 32 miles from the point of failure. Experience shows that pilots typically attempt to quickly land at the

airport when incidents occur during these conditions. Thus, it is extremely unlikely that accidents during these operational phases will result in an aircraft impact at the SDA site, even if the incident begins at an altitude of more than 10,000 feet. These accidents are also screened out of the SDA analyses.

Accidents during the "Climb" and "Descent" phases of flight operations may occur at any altitude between approximately 10,000 feet and normal cruising altitudes (typically 30,000 to 40,000 feet). Disabling incidents that occur at these intermediate altitudes may result in an aircraft impact at the SDA site, and they are included in the scope of this analysis.

The following model is used in this analysis to obtain the annual frequency of impacts due to commercial aircraft operations in the vicinity of the Buffalo Niagara International Airport. The frequency of an aircraft crash per unit surface area is given by:

$$F_V = \sum N_o * C_o / A_o \quad (5.6.1)$$

where

- F_V = Airport vicinity crash frequency per year and square mile
- N_o = Number of airport operations per year
- C_o = Crash rate for commercial aircraft (per operation)
- A_o = Area within which an airport vicinity crash can occur (square miles)
- o = Phase of aircraft operation (climb, descent)

Number of Airport Operations per Year

Reference 5.6-4 summarizes the following Buffalo Niagara International Airport operational statistics for the 12-month period ending December 31, 2006.

- Aircraft operations: 377 per day (average)
- 57% commercial
- 15% transient general aviation
- 13% local general aviation
- 13% air taxi
- 1% military

"Aircraft operations" account for the total number of takeoffs and landings that occur at the airport. It is assumed that the "commercial" category includes 14CFR121 Carriers and 14CFR135 Scheduled Carriers. It is also assumed that the "air taxi" category applies to 14CFR135 On-Demand Carriers.

According to these assumptions, the annual commercial air traffic at Buffalo Niagara International Airport is estimated to be:

- N_T = Total number of airport operations
= 137,605 takeoffs and landings per year
- N_{C1} = Number of airport operations for 14CFR121 and 14CFR135 scheduled carriers
= 78,435 takeoffs and landings per year

N_{C2} = Number of airport operations for 14CFR135 on-demand carriers
= 17,889 takeoffs and landings per year

The potential impacts from military and general aviation aircraft crashes are evaluated in other sections of this analysis.

Commercial Aircraft Crash Rates

For this analysis, accidents in the NTSB "Not Reported" category are allocated among the nine operational phases according to the relative percentage of accidents in each phase. Thus, the total percentages of all accidents that occur during "Climb" and "Descent" are:

- 14CFR121 Carriers: 14.5% of all accidents
- 14CFR135 Scheduled Carriers: 17.7% of all accidents
- 14CFR135 On-Demand Carriers: 7.9% of all accidents

The NTSB data in Reference 5.6-1 report the number of departures for 14CFR121 Carriers and 14CFR135 Scheduled Carriers. For this analysis, a "departure" in the NTSB database is considered to be a "flight", which includes a takeoff, transit at cruise altitude, and a landing. Thus, the number of NTSB "departures" must be multiplied by 2 for equivalence with the total number of "aircraft operations" (i.e., the sum of all takeoffs and landings) in the airport data summaries. The NTSB data include only the estimated number of flight hours for 14CFR135 On-Demand Carriers.

14CFR121 and 14CFR135 Scheduled Carriers

The composite accident rate per climb or descent for these carriers is estimated from the following information.

- 14.5% of all 14CFR121 Carrier accidents occur during "Climb" and "Descent"
- 499 total 14CFR121 Carrier accidents in NTSB database
- 224,446,637 14CFR121 Carrier departures in NTSB database

- 17.7% of all 14CFR135 Scheduled Carrier accidents occur during "Climb" and "Descent"
- 331 total 14CFR135 Scheduled Carrier accidents in NTSB database
- 49,141,267 14CFR135 Scheduled Carrier departures in NTSB database

C_{C1} = Crash rate for 14CFR121 and 14CFR135 Scheduled Carriers
= $(0.145 * 499 + 0.177 * 331) / [2 * (224,446,637 + 49,141,267)]$
= 2.39E-07 crash per climb or descent

14CFR135 On-Demand Carriers

The accident rate per climb or descent for these carriers is estimated from the following information.

- 7.9% of all 14CFR135 On-Demand Carrier accidents occur during "Climb" and "Descent"
- 2,224 total 14CFR135 On-Demand Carrier accidents in NTSB database
- 73,951,000 14CFR135 On-Demand Carrier flight hours in NTSB database

The number of departures for these carriers is estimated by assuming that the average number of flight hours per departure for 14CFR135 On-Demand Carriers is the same as the average number of flight hours per departure for 14CFR135 Scheduled Carriers. In other words, it is assumed that these carriers operate generally similar aircraft over generally similar distances per flight. The NTSB database for 14CFR135 Scheduled Carriers contains the following information.

- 34,921,127 14CFR135 Scheduled Carrier flight hours
- 49,141,267 14CFR135 Scheduled Carrier departures

$$\begin{aligned} D_{C2} &= \text{Estimated departures for 14CFR135 On-Demand Carriers} \\ &= (73,951,000) * (49,141,267 / 34,921,127) \\ &= 104,064,392 \text{ departures} \end{aligned}$$

$$\begin{aligned} C_{C2} &= \text{Estimated crash rate for 14CFR135 On-Demand Carriers} \\ &= (0.079 * 2,224) / (2 * 104,064,392) \\ &= 8.44E-07 \text{ crash per climb or descent} \end{aligned}$$

Aircraft Crash Exposure Area

The following assumptions are used to estimate the crash impact exposure area for each operational phase.

As noted above, the "Climb" and "Descent" phases typically span altitudes between approximately 10,000 feet and normal cruising altitude. If an incident occurs at an average altitude of approximately 22,500 feet and the aircraft maintains a glide ratio of 17, the maximum potential impact distance is approximately 72 miles from the point of failure.

It is assumed that incidents during climbs may cause crashes that are distributed uniformly throughout a 360° circle with a radius of 72 miles that is centered at the airport. This assumption accounts for the fact that climbs begin from a controlled takeoff direction. However, aircraft often turn during the climb phase to enter fixed departure corridors that align with their final cruising corridors. Experience from crashes that have occurred during departure also shows that pilots often try to return to the airport, resulting in maneuvers that can orient the aircraft in any direction. This assumption introduces some conservatism because it includes all climbs, regardless of their orientation and distance from the center of the airport. However, it also introduces some optimism because it allows the impact to occur anywhere within a full 360° circle.

It is assumed that incidents during descent may cause crashes that are distributed uniformly throughout a 360° circle with a radius of 72 miles that is centered at the airport. This assumption accounts for the fact that descents begin from several different directions as aircraft are aligned into the final approach pattern. The actual crash dispersion angle is probably 45° or less in the forward direction, but the aircraft descend from multiple directions. For example, if the final approach is from the northeast, some aircraft may begin their descent during the downwind leg, parallel to the airport runway. This assumption introduces some conservatism because it includes all descents, regardless of their orientation and distance from the center of the airport. However, it also introduces some optimism because it allows the impact to occur anywhere within a full 360° circle.

$$\begin{aligned}
A_{CD} &= \text{Area within which a "Climb" or "Descent" crash can occur} \\
&= \pi * (72)^2 \\
&= 16,286 \text{ square miles}
\end{aligned}$$

Airport Vicinity Crash Rate Density

Equation (5.6.1) is evaluated using the annual number of takeoffs and landings for each type of carrier, the accident rates for climb and descent operations, and the impact exposure areas for these accidents. The resulting crash rate density from "Climb" and "Descent" accidents in the vicinity of the Buffalo Niagara International Airport is:

$$\begin{aligned}
F_{VB} &= (N_{C1} * C_{C1} + N_{C2} * C_{C2}) / A_{CD} \\
&= (78,435 * 2.39E-07 + 17,889 * 8.44E-07) / 16,286 \\
&= 1.15E-06 + 9.27E-07
\end{aligned}$$

$$F_{VB} = 2.08E-06 \text{ crash per year per square mile}$$

There is relatively small uncertainty in the NTSB commercial aircraft accident frequency data. A moderate amount of uncertainty is introduced by the assumptions and models that are used to estimate the crash exposure area. The calculated value for F_{VB} is used as the mean value of a lognormal distribution, and an error factor of 5 is assigned to account for these sources of uncertainty.

Airport Vicinity Commercial Aircraft Crash Frequency Distribution, F_{VB} (accidents per year per square mile)				
5th Percentile	Median	95th Percentile	Mean	Error Factor
2.58E-07	1.29E-06	6.44E-06	2.08E-06	5

5.6.1.2 In-Transit Accidents

Incidents that begin during the "Cruise" phase of flight operations may result in an aircraft impact at the SDA site. Commercial flights typically operate under active air traffic control at cruise altitudes between approximately 30,000 feet and 40,000 feet in the High Altitude flight corridors listed in Table 5.6-2.

It was not possible to obtain data for the annual number of flights in each air corridor. Therefore, the actual commercial flight densities over the area surrounding the site could not be estimated very precisely for this analysis.

Reference 5.6-5 summarizes the following data for the frequency of commercial aircraft crashes during cruise operations. The crash rate densities apply for an "average" location in the continental United States.

Carrier Type	Non-Airport Operation Crash Rate (crash per year per square mile)		
	Minimum	Average	Maximum
Air Carrier	7E-08	4E-07	2E-06
Air Taxi	4E-07	1E-06	8E-06

The following sections describe how these generic crash rates were adjusted to account for the conditions that apply in the area surrounding the West Valley site.

Uncertainty Distributions

Reference 5.6-5 lists a "minimum", "average", and "maximum" value for each in-flight crash rate. The tabulated values have only single digit precision, which indicates that the report authors intend them to be considered as only approximate values.

For this study, the following lognormal uncertainty distributions are used to quantify the respective crash rates.

Commercial Aircraft In-Flight Crash Frequency Distributions, F_{AC} and F_{AT} (accidents per year per square mile)					
Carrier Type	5th Percentile	Median	95th Percentile	Mean	Error Factor
Air Carrier	8.00E-08	4.00E-07	2.00E-06	6.46E-07	5
Air Taxi	5.00E-07	2.00E-06	8.00E-06	2.85E-06	4

The lognormal distribution F_{AC} for Air Carrier aircraft is a very close approximation to the range of crash rates cited in Reference 5.6-5. The lognormal distribution F_{AT} for Air Taxi aircraft does not fit the tabulated crash rates as well. The lognormal is a good approximation for the "minimum" and "maximum" crash rates cited in the reference. However, the lognormal median value is twice the reference "average" value. Thus, use of the lognormal distribution may produce numerical results that are somewhat conservative for the frequency of Air Taxi crashes.

Air Traffic Density in Site Area

The crash rate densities tabulated in Reference 5.6-5 apply for an "average" location in the continental United States. Air traffic densities in the Northeast are much higher than in most regions of the country. This observation is clearly evident from air traffic displays and is supported by the number of air traffic control corridors listed in Table 5.6-2. However, as noted above, it was not possible to obtain actual flight density data for the specific corridors near the site.

The following subjective probability distribution is used in this analysis to scale the crash rates for an "average" location in the continental United States to crash rates that may apply for the

area surrounding the West Valley site. These probabilities are based only on the judgment of the project team, and they are not derived from actual flight data.

Crash Rate Scaling for West Valley Site Region	
Crash Rate Multiplier, M_c	Probability
1.0	0.05
2.0	0.20
3.0	0.50
4.0	0.20
5.0	0.05

Thus, a 5% probability is assigned that the crash rate density for an "average" U.S. location applies for the region surrounding the West Valley site. A 20% probability is assigned that the flight densities (and, hence, the crash rates) in the area surrounding West Valley are twice those for an "average" U.S. location, and so forth.

Mix of Commercial Aircraft in Site Area

Reference 5.6-5 tabulates different crash rates for Air Carrier aircraft and for Air Taxi aircraft. No data are available to determine the actual allocations of these aircraft in the flight corridors surrounding the West Valley site. According to Reference 5.6-4, approximately 57% of the traffic at Buffalo Niagara International Airport is classified as "commercial" carriers, and approximately 13% is classified as "air taxi" services. It is assumed for this analysis that these relative percentages also apply for the commercial air traffic in the regional flight corridors. Thus, it is assumed that:

- $f_{AC} = 81.4\%$ (57 / 70) of the commercial traffic is Air Carrier aircraft
- $f_{AT} = 18.6\%$ (13 / 70) of the commercial traffic is Air Taxi aircraft

In-Transit Crash Rate Density

The total in-transit crash rate density for commercial aircraft is quantified as follows:

$$F_{CT} = f_{AC} * M_C * F_{AC} + f_{AT} * M_C * F_{AT} \quad (5.6.2)$$

where

- F_{CT} = In-transit crash frequency per year and square mile
- f_{AC} = Fraction of air traffic allocated to Air Carrier aircraft
- F_{AC} = Air Carrier crash rate for "average" U.S. location (per year and square mile)
- f_{AT} = Fraction of air traffic allocated to Air Taxi aircraft
- F_{AT} = Air Taxi crash rate for "average" U.S. location (per year and square mile)
- M_C = Scaling factor for commercial air traffic densities in West Valley region

Equation (5.6.2) was solved using the lognormal uncertainty distributions for F_{AC} and F_{AT} , the subjective probability distribution for M_C , and the fractions f_{AC} and f_{AT} to yield the following composite crash frequency distribution.

In-Transit Commercial Aircraft Crash Frequency Distribution, F_{CT} (accidents per year per square mile)				
5th Percentile	Median	95th Percentile	Mean	Error Factor
6.85E-07	2.38E-06	8.11E-06	3.16E-06	3.4

This composite frequency has equal contributions from Air Carrier and Air Taxi crashes. The uncertainty distribution is not necessarily lognormal. The error factor listed above is calculated from the square root of the ratio of the 95th and 5th probability percentiles. It is shown only for general information regarding the range of uncertainty about this frequency. The uncertainty in the composite frequency is somewhat reduced from the input distributions (i.e., F_{AC} and F_{AT}), primarily due to the influence from the Air Taxi crash distribution.

5.6.1.3 Total Commercial Aircraft Crash Frequency

The geomembrane-covered area of the SDA trenches is approximately 13 acres, or approximately 2.03E-02 square miles (Reference 5.6-6). Therefore, the annual frequency of commercial aircraft crashes that impact the SDA trenches is:

$$\lambda_{AC-C} = (F_{VB} + F_{CT}) * A_{SDA}$$

where

- λ_{AC-C} = Frequency of commercial aircraft crashes that impact the SDA (event / year)
- F_{VB} = Commercial aircraft crash frequency in Buffalo vicinity [event / (year - square mile)]
- F_{CT} = Commercial aircraft in-transit crash frequency [event / (year - square mile)]
- A_{SDA} = SDA area (square miles)

SDA Commercial Aircraft Crash Frequency, λ_{AC-C} (event / year)				
5th Percentile	Median	95th Percentile	Mean	Error Factor
3.16E-08	8.54E-08	2.46E-07	1.06E-07	2.8

About 60% of this crash frequency is due to in-flight incidents that occur in the air transit corridors, and about 40% is due to Climb and Descent operations for flights into Buffalo Niagara International Airport.

5.6.2 Military Aircraft Crash Frequency

Reference 5.6-5 summarizes the following data for the frequency of military aircraft crashes.

Military Aircraft Type	Airport Operation Crash Rate (crash per event)		Non-Airport Operation Crash Rate (crash per year per square mile)		
	Takeoff	Landing	Minimum	Average	Maximum
Large	5.7E-07	1.6E-06	6E-08	2E-07	7E-07
Small	1.8E-06	3.3E-06	4E-08	4E-06	6E-06

In these summaries, "Large" military aircraft include bombers, cargo aircraft, and tankers. "Small" military aircraft include fighters, attack aircraft, and trainers.

The crash rates for non-airport operations apply for an average location in the continental United States. They are based on military aircraft crashes during "normal" in-flight operations. In particular, these crash rates do not apply for activities associated with special maneuvering and low level flights at military operations areas (MOAs) and training ranges. Higher crash rates apply for locations in or near those areas, but they are not currently tabulated in publicly-available references.

5.6.2.1 Accidents in Vicinity of Air Bases

Niagara Falls Air Reserve Station is the closest military air base to the West Valley site. It is located at the Niagara Falls International Airport, approximately 48 miles north-northwest from the site, near Niagara Falls. The air base is home for the New York Air National Guard 107th Airlift Wing and Air Refueling Wing, and the Niagara Falls Air Force Reserve 914th Airlift Wing.

Reference 5.6-5 contains summaries of the potential impact distances for military aircraft crashes during airport operations. These summaries show that the maximum potential impact distance for takeoff and landing crashes is approximately 22 miles from the airport, based on operating experience and the definitions of military aircraft operations that are used in the reference.

The West Valley site is located substantially further than 22 miles from any military air base. Therefore, potential impacts from accidents that occur during takeoff and landing operations are screened out of the SDA analyses.

5.6.2.2 Training Accidents

Air navigation charts show that the following MOAs are closest to the West Valley site.

- The Duke MOA is located south-southeast of the site, in northern Pennsylvania. The MOA boundary extends slightly over the New York State border, just southwest of Olean. The minimum distance from the MOA border to the West Valley site is approximately 28 miles.

- The Misty 1, Misty 2, and Misty 3 MOAs extend over the southern area of Lake Ontario, from north of Buffalo to east of Rochester. The minimum distance from the MOA border to the West Valley site is approximately 60 miles.

Based on these distances, military aircraft crashes during training operations in MOAs are screened out of the SDA analyses.

5.6.2.3 In-Flight Accidents

No information is available to determine whether the number of military aircraft flights over the area surrounding the West Valley site is more or less than that for an "average" location in the continental United States, as considered in Reference 5.6-5. Based on the lack of large air bases in the region and the distance from flight training areas, it is likely that the military air traffic density in the area surrounding the site is typical of an "average" U.S. location. Therefore, the military aircraft crash rates for non-airport operations from Reference 5.6-5 are used directly for the SDA analyses.

Reference 5.6-5 lists a "minimum", "average", and "maximum" value for each in-flight crash rate. The tabulated values have only single digit precision, which indicates that the report authors intend them to be considered as only approximate values.

For this study, the following lognormal uncertainty distributions are used to quantify the respective crash rates.

Military Aircraft In-Flight Crash Frequency Distributions, F_{ML} and F_{MS} (accidents per year per square mile)					
Aircraft Type	5th Percentile	Median	95th Percentile	Mean	Error Factor
Large	5.71E-08	2.00E-07	7.00E-07	2.67E-07	3.5
Small	8.57E-07	3.00E-06	1.05E-05	4.01E-06	3.5

The lognormal distribution F_{ML} for large aircraft is a very close approximation to the range of crash rates cited in Reference 5.6-5. The lognormal distribution F_{MS} for small aircraft does not fit the tabulated crash rates as well. The tabulated range for the small aircraft crash rates is very broad, and the "average" value is only slightly lower than the "maximum" value. The lognormal distribution provides a reasonable fit to the upper end of the frequency range, but it does not fully extend to the lower end of the range. Thus, use of the lognormal distribution F_{MS} may produce numerical results that are slightly conservative for the frequency of small aircraft crashes.

5.6.2.4 Total Military Aircraft Crash Frequency

Only in-flight incidents that affect military aircraft may cause a crash that impacts the SDA site. The geomembrane-covered area of the SDA trenches is approximately 13 acres, or

approximately 2.03E-02 square miles (Reference 5.6-6). Therefore, the annual frequency of military aircraft crashes that impact the SDA trenches is:

$$\lambda_{AC-M} = (F_{ML} + F_{MS}) * A_{SDA}$$

where

- λ_{AC-M} = Frequency of military aircraft crashes that impact the SDA (event / year)
- F_{ML} = Large military aircraft crash frequency [event / (year - square mile)]
- F_{MS} = Small military aircraft crash frequency [event / (year - square mile)]
- A_{SDA} = SDA area (square miles)

SDA Military Aircraft Crash Frequency, λ_{AC-M} (event / year)				
5th Percentile	Median	95th Percentile	Mean	Error Factor
2.18E-08	6.65E-08	2.17E-07	8.69E-08	3.2

About 94% of this crash frequency is due to in-flight incidents that involve small aircraft, and about 6% is due to incidents that involve large aircraft.

5.6.3 General Aviation Aircraft Crash Frequency

Accident statistics for general aviation aircraft from 1975 through 2007 are tabulated by the U.S. National Transportation Safety Board in Reference 5.6-1. The NTSB data include only the number of reported accidents and the estimated total number of flight hours for these aircraft.

NTSB General Aviation Accident Data, 1975 – 2007		
Accidents	Total Flight Hours	Accident Rate per Flight Hour
82,693	919,538,000	8.99E-05

Reference 5.6-5 summarizes the following data for the frequency of general aviation aircraft crashes.

Aircraft Type	Airport Operation Crash Rate (crash per event)		Non-Airport Operation Crash Rate (crash per year per square mile)		
	Takeoff	Landing	Minimum	Average	Maximum
Fixed Wing	1.1E-05	2.0E-05	1E-07	2E-04	3E-03
Helicopter	2.5E-05	N/A	N/A	N/A	N/A

Explanatory notes indicate that helicopter crashes are considered in the reference analyses only on a per-flight basis, and all helicopter accidents are reported for convenience under

Takeoff operations. The fixed wing aircraft crash rates for non-airport operations apply for an average location in the continental United States.

5.6.3.1 Accidents in Vicinity of Airfields

Table 5.6-1 shows that the following general aviation airfields are located closest to the West Valley site.

- A small airfield is located approximately 2 miles north of Arcade, approximately 14 miles northeast of the site. The airfield has one compacted gravel runway and one grass runway.
- A small airfield is located approximately 2 miles north of Gowanda, approximately 16 miles west-northwest of the site. The airfield has a single grass runway.
- A small airfield is located approximately 5 miles northeast of Salamanca, approximately 17 miles south of the site. The airfield has a single grass runway.
- The Cattaraugus County – Olean Municipal Airport is located near Ischua, approximately 20 miles south-southeast of the site. The airport has one paved runway and one grass runway.

Reference 5.6-5 contains summaries of the potential impact distances for general aviation aircraft crashes during airport operations. These summaries show that the maximum potential impact distance for takeoff and landing crashes is approximately 16 miles from the airport, based on operating experience and the definitions of aircraft operations that are used in the reference.

The West Valley site is located within the limiting distance for potential impacts from crashes during eastward landings at the Arcade Tri-County airfield. The crash pattern summaries in Reference 5.6-5 indicate that only approximately $2.6E-04$ of all general aviation landing crashes impact the ground between 14 and 16 miles from the airfield. Reference 5.6-7 indicates that the airfield has an average of 36 total takeoffs and landings per week, and it is closed during the winter months. Based on the size of the airfield, its small amount of traffic, and its distance from the site, it is concluded that potential impacts from takeoff and landing operations can be screened out of the SDA analyses.

The West Valley site is located at the limiting distance for potential impacts from crashes during westward landings at the Gowanda airfield. The crash pattern summaries in Reference 5.6-5 indicate that only approximately $1.2E-05$ of all general aviation landing crashes impact the ground at 16 miles from the airfield. Reference 5.6-8 indicates that the airfield has an average of 69 total takeoffs and landings per week. Based on the size of the airfield, its small amount of traffic, and its distance from the site, it is concluded that potential impacts from takeoff and landing operations can be screened out of the SDA analyses.

The site is located approximately 17 miles from the Great Valley airfield and approximately 20 miles from the Cattaraugus County – Olean Municipal Airport. Therefore, aircraft crashes during takeoff and landing operations at those airfields do not have a potential impact on the SDA.

5.6.3.2 In-Flight Accidents

Incidents that begin during in-flight operations may result in an aircraft impact at the SDA site. General aviation flights typically operate at altitudes below 10,000 feet under Visual Flight Rules (VFR), or in the Low Altitude flight corridors listed in Table 5.6-2.

It was not possible to obtain data for the annual number of flights in each air corridor. Therefore, the actual general aviation flight densities over the area surrounding the site could not be estimated very precisely for this analysis.

The following sections describe how the generic crash rate data from Reference 5.6-5 were adjusted to account for the conditions that apply in the area surrounding the West Valley site.

Uncertainty Distribution

Reference 5.6-5 lists a "minimum", "average", and "maximum" value for the in-flight crash rate. The tabulated values have only single digit precision, which indicates that the report authors intend them to be considered as only approximate values.

For this study, the following lognormal uncertainty distribution is used to quantify the crash rate.

General Aviation Aircraft In-Flight Crash Frequency Distribution, F_G (accidents per year per square mile)				
5th Percentile	Median	95th Percentile	Mean	Error Factor
1.33E-05	2.00E-04	3.00E-03	7.75E-04	15

The lognormal distribution is only an approximate fit to the tabulated crash rates in Reference 5.6-5. The tabulated range of crash rates is extremely broad, and the "average" value is much closer to the "maximum" than the "minimum". The lognormal distribution provides a reasonable fit to the upper end of the frequency range, but it does not fully extend to the lower end of the range. Thus, use of the lognormal distribution may produce numerical results that are somewhat conservative for the frequency of general aviation aircraft crashes.

Air Traffic Density in Site Area

The crash rate densities tabulated in Reference 5.6-5 apply for an "average" location in the continental United States. It seems likely that general aviation air traffic densities in the area surrounding the site are higher than in most regions of the country. This observation is supported by the number of general aviation airports and airfields shown in Table 5.6-1 and the number of Low Altitude air control corridors listed in Table 5.6-2. However, as noted above, it was not possible to obtain actual flight density data for the specific corridors near the site.

The following subjective probability distribution is used in this analysis to scale the crash rates for an "average" location in the continental United States to crash rates that may apply for the area surrounding the West Valley site. These probabilities are based only on the judgment of the project team, and they are not derived from actual flight data.

Crash Rate Scaling for West Valley Site Region	
Crash Rate Multiplier, M_G	Probability
1.0	0.20
2.0	0.50
3.0	0.30

Thus, a 20% probability is assigned that the crash rate density for an "average" U.S. location applies for the region surrounding the West Valley site. A 50% probability is assigned that the flight densities (and, hence, the crash rates) in the area surrounding West Valley are twice those for an "average" U.S. location, and so forth.

In-Flight Crash Rate Density

The total in-flight crash rate density for general aviation aircraft is quantified as follows:

$$F_{GT} = M_G * F_G \quad (5.6.3)$$

where

- F_{GT} = In-flight crash frequency per year and square mile
- M_G = Scaling factor for general aviation air traffic densities in West Valley region
- F_G = General aviation crash rate for "average" U.S. location (per year and square mile)

Equation (5.6.3) was solved using the lognormal uncertainty distribution for F_G and the subjective probability distribution for M_G to yield the following crash frequency distribution.

In-Flight General Aviation Aircraft Crash Frequency Distribution, F_{GT} (accidents per year per square mile)				
5th Percentile	Median	95th Percentile	Mean	Error Factor
2.41E-05	3.93E-04	6.19E-03	1.65E-03	16.0

The error factor listed above is calculated from the square root of the ratio of the 95th and 5th probability percentiles. It is shown only for general information regarding the range of uncertainty about this frequency. The uncertainty is somewhat increased from the input distribution (i.e., F_G), due to the uncertainty in the air traffic density scaling factor.

5.6.3.3 Total General Aviation Aircraft Crash Frequency

Only in-flight incidents that affect general aviation aircraft may cause a crash that impacts the SDA site. The geomembrane-covered area of the SDA trenches is approximately 13 acres, or approximately 2.03E-02 square miles (Reference 5.6-6). Therefore, the annual frequency of general aviation aircraft crashes that impact the SDA trenches is:

$$\lambda_{AC-G} = F_{GT} * A_{SDA}$$

where

λ_{AC-G} = Frequency of general aviation aircraft crashes that impact the SDA (event / year)

F_{GT} = General aviation aircraft crash frequency [event / (year - square mile)]

A_{SDA} = SDA area (square miles)

SDA General Aviation Aircraft Crash Frequency, λ_{AC-G} (event / year)				
5th Percentile	Median	95th Percentile	Mean	Error Factor
4.89E-07	7.98E-06	1.26E-04	3.36E-05	16.0

5.6.4 References

- 5.6-1. News Bulletin SB-08-14, National Transportation Safety Board, April 16, 2008, www.nts.gov/aviation/stats_yr.htm
- 5.6-2. "Annual Review of Aircraft Accident Data, U.S. Air Carrier Operations, Calendar Year 1997", PB2002-106890, NTSB/ARC-02/01, National Transportation Safety Board, January 24, 2002
- 5.6-3. "Annual Review of Aircraft Accident Data, U.S. Air Carrier Operations, Calendar Year 2003", PB2007-105389, NTSB/ARC-07/01, National Transportation Safety Board, December 12, 2006 (amended August 8, 2007)
- 5.6-4. "Buffalo Niagara International Airport, Airport Operational Statistics", 12-month period ending December 31, 2006, www.airnav.com/airport/KBUF
- 5.6-5. "Accident Analysis for Aircraft Crash into Hazardous Facilities", DOE Standard, DOE-STD-3014-2006, U.S. Department of Energy, October 1996, Reaffirmation May 2006
- 5.6-6. E-mail communication, M. R. Weishan, NYSERDA, to J. W. Stetkar, June 2, 2008
- 5.6-7. "Arcade Tri-County Airport, Airport Operational Statistics", 12-month period ending October 20, 2006, www.airnav.com/airport/D23
- 5.6-8. "Gowanda Airport, Airport Operational Statistics", 12-month period ending July 19, 2006, www.airnav.com/airport/D59

Table 5.6-1. Airports and Airfields within 50 Miles of West Valley Site			
Airport	Designation	Distance from SDA (miles)	Direction from SDA
Large Commercial			
Buffalo Niagara International	BUF	34.3	N
Light Commercial / General Aviation			
Chautauqua County / Jamestown	JHW	37.2	SW
Bradford (PA)	BFD	44.6	S
General Aviation			
Arcade Tri-County	D23	14.0	NE
Gowanda	D59	15.9	WNW
Great Valley	N56	16.8	S
Cattaraugus County / Olean	OLE	20.2	SSE
Hamburg	4G2	22.2	NW
Buffalo	9G0	28.9	N
Giermek Executive	8G3	29.0	SSE
Chautauqua County / Dunkirk	DKK	32.0	W
Buffalo – Lancaster	BQR	32.9	N
Perry – Warsaw	01G	36.7	NE
Randolph	D85	38.2	SE
Akron	9G3	40.6	NNE
Wellsville	ELZ	40.9	SE
East Amherst / Clarence	D51	43.0	N
Dart	D79	44.3	SW
Genesee County / Batavia	GVQ	47.2	NNE
Geneseo	D52	47.7	NE
Dansville	DSV	48.5	ENE
Hornell	4G6	49.6	ESE
Royalton	9G5	51.0	N
Le Roy	5G0	51.7	NE

Table 5.6-1. Airports and Airfields within 50 Miles of West Valley Site

Airport	Designation	Distance from SDA (miles)	Direction from SDA
Albion / Pine Hill	9G6	53.7	NNE
Military / Light Commercial / General Aviation			
Niagara Falls International	IAG	48.1	NNW

Table 5.6-2. Air Traffic Control Corridors in Vicinity of West Valley Site

Corridor Designation	End Points	General Orientation	Approximate Minimum Distance from Site (miles)
High Altitude Corridors			
J109	Buffalo – Linden	N – S	1.0
J61	Buffalo – Philipsburg	NNW – SSE	3.5
J29	Syracuse – Jamestown	NE – SW	6.0
J36	Dunkirk – Lake Henry	NW – SE	7.5
J82	Albany – Jamestown	ENE – WSW	14.0
J220	Buffalo – Wellsville	NNW – SSE	14.5
J95	Buffalo – Binghamton	NW – SE	26.0
J16-94	Albany – Buffalo	E – W	28.0
Low Altitude Corridors			
V33	Buffalo – Bradford	N – S	2.0
V464	Geneseo – Dunkirk	ENE – WSW	10.0
V164	Buffalo – Wellsville	NNW – SSE	15.0
V270	Wellsville – Jamestown	E – W	17.5
V115	Buffalo – Jamestown	NNE – SSW	18.0
V14	Buffalo – Dunkirk	NE – SW	23.5
V36	Buffalo – Elmira	NW – SE	23.5
V265	Jamestown – Bradford	NW – SE	30.5
V119	Wellsville – Bradford	NE – SW	32.0

5.7 METEORITE IMPACTS

This section describes the derivation of impact frequencies for meteorites that may strike the SDA. Preliminary analyses concluded that the impact frequencies for large meteorites and asteroids are sufficiently small to justify screening those threats from further consideration. However, that conclusion does not apply to meteorites with diameters of less than approximately 1 meter. Although the frequency of these impacts is very small in an absolute sense, it is comparable to the frequencies of other threats that are evaluated in this study. Therefore, the analyses in this section focus primarily on meteorites in this size range.

5.7.1 Data Sources

Numerous studies during the last decade have described efforts to estimate the impact frequencies for large asteroids that have potentially cataclysmic global consequences. Much less emphasis has been placed on quantifying the impact frequencies for mid- to small-sized meteorites that are relatively frequent events, but are inconsequential on a regional, national, or global scale. The QRA team found few citable references for the frequencies of these events, with rather large variability in anecdotal estimates. This experience is likely due to the fact that few researchers are concerned about these events, and they do not compile documented data consistently for impacts at the small end of the size range.

The QRA team derived the estimates for this study primarily from analyses performed by the National Aeronautics and Space Administration (NASA, Reference 5.7-1) and a joint team from the NASA Ames Research Center, the University of California at Los Angeles, and Lawrence Livermore National Laboratory (Reference 5.7-2). Those studies were also concerned primarily with the estimation of frequencies for very severe asteroid impacts. Therefore, their results focus on effective impact energies in the range from 1 megaton to 100 million megatons equivalent TNT yield. However, their supporting data and models provide sufficient information to transform their results into correlations of impact frequency as a function of effective object diameter. Those results are not reported directly in either study, but they were derived by the QRA team. Figure 5.7-1 compares these estimates.

5.7.2 Frequency Extrapolations

Figure 5.7-1 clearly illustrates the researchers' primary concerns with impacts from very large objects. The minimum effective diameter derived from the NASA results (Reference 5.7-1) is slightly more than 31 meters. The NASA estimated frequency for a 31-meter object striking a specific area of the Earth that is the size of the SDA is approximately $3.3\text{E-}13$ event per year (one event in 3.1 trillion years). The Toon results (Reference 5.7-2) extend to somewhat smaller objects with a minimum effective diameter of approximately 7 meters. The Toon frequency for a 7-meter object striking a specific area the size of the SDA is approximately $2.1\text{E-}10$ event per year (one event in 4.9 billion years).

Both studies indicate an approximately logarithmic relationship between impact frequency and object size. Therefore, these relationships were extrapolated to derive impact frequencies for smaller objects. These extrapolations are shown in Figure 5.7-2. The QRA team judged that impacts from meteorites with diameters less than 0.1 meter could cause localized damage to the geomembrane covers, but these objects would not have sufficient energies to penetrate the SDA trench caps to the depth of the waste materials.

5.7.3 Meteorite Impact Frequencies

Figures 5.7-1 and 5.7-2 show consistent differences between the NASA and Toon results. For a given object size, the Toon results predict impact frequencies that are typically six to ten times higher than the NASA estimates.

The QRA team concluded that it would be inappropriate to select only the NASA results or only the Toon results to characterize the meteorite impact frequency for the SDA risk analyses. Therefore, composite impact frequencies were developed by probabilistically combining the NASA and Toon estimates. In this process, the NASA results were assigned a probabilistic weight of 70% that they are the "true" representation of the meteorite hazard. The Toon results were assigned a weight of 30%. A higher weight was assigned to the NASA results primarily because they are derived from more recent and more comprehensive data on the populations of near-Earth objects and their relative energies. The NASA correlations assume an impact velocity of 20 km / sec, while the Toon correlations assume an impact velocity of 15 km / sec.

It was also assumed that the NASA and Toon impact frequencies are "best estimate" median values. Lognormal distributions were used to quantify the uncertainties about these estimates. An error factor of 5 (numerically equivalent to a 90% confidence interval of 25) was assigned to characterize the range of uncertainty in each estimate. These relatively moderate uncertainties are justified because the estimates for this study apply to "relatively frequent" events, for which measurable impact frequency data are available (although not consistently compiled or reported). Larger uncertainties apply to estimates of impact frequencies for larger objects, due to the sparsity of available data and uncertainties about the modeling correlations for very large objects.

In summary, each curve in Figure 5.7-2 was characterized as the median value of a lognormal uncertainty distribution about the respective researchers' results. The range of uncertainty in each estimate was represented by an error factor of 5. The NASA results were assigned a probability weight of 70% that they are the "true" representation of the meteorite hazard, and the Toon results were assigned a weight of 30%. The probability-weighted distributions were then merged (not added) to preserve the composite uncertainties. Figure 5.7-3 shows the resulting composite meteorite impact frequency curves that are used in the SDA risk analyses. It should be noted that these curves are displayed only for objects in the size range of 0.1 meter to 10 meters in diameter. The frequencies also apply to an impact anywhere on the Earth's surface, for consistent comparisons with the results in Figure 5.7-1 and Figure 5.7-2.

The annual frequency of meteorite strikes that impact the SDA trenches is:

$$\lambda_{\text{MSDA}} = F_{\text{ME}} * (A_{\text{SDA}} / A_{\text{E}})$$

where

- λ_{MSDA} = Frequency of meteorite strikes that impact the SDA (event / year)
- F_{ME} = Frequency of meteorite strikes that impact the Earth's surface (event / year)
- A_{SDA} = SDA area (square kilometers)
- A_{E} = Earth surface area (square kilometers)

The Earth has a surface area of approximately 510,070,000 square kilometers (approximately 196,940,000 square miles). The geomembrane-covered area of the SDA trenches is approximately 13 acres, or approximately 5.26E-02 square kilometers (2.03E-02 square miles, Reference 5.7-3).

Figure 5.7-4 shows the results from this calculation. Table 5.7-1 summarizes the composite uncertainty distributions for the SDA impact frequencies for a variety of meteorite sizes from an effective diameter of 10 meters to 0.1 meter. The uncertainty distributions are not lognormal. The error factors are listed only as a numerical measure of the uncertainty over the 90% confidence interval of each distribution. The composite uncertainties are larger than the ranges applied individually to the NASA and Toon results, because the probabilistic merging process appropriately preserves the contributions from the upper- and lower-bound uncertainty "tails" of each input distribution.

5.7.4 References

- 5.7-1. "Study to Determine the Feasibility of Extending the Search for Near-Earth Objects to Smaller Limiting Diameters", Report of the Near-Earth Object Science Definition Team, Office of Space Science, Solar System Exploration Division, National Aeronautics and Space Administration, August 2003
- 5.7-2. "Environmental Perturbations Caused by the Impacts of Asteroids and Comets", Toon, O. B., R. P. Turco, C. Covey, K. Zahnle, and D. Morrison, *Reviews of Geophysics*, 35, 1, 41–78, February 1997
- 5.7-3. E-mail communication, M. R. Weishan, NYSERDA, to J. W. Stetkar, June 2, 2008

Table 5.7-1. SDA Meteorite Impact Frequencies					
Diameter (m)	Impact Frequency (event / year)				
	5th Percentile	Median	Mean	95th Percentile	Error Factor
10	9.99E-13	7.15E-12	3.55E-11	1.60E-10	12.7
3	1.75E-11	1.27E-10	8.53E-10	4.00E-09	15.1
1	2.50E-10	1.79E-09	8.87E-09	4.00E-08	12.7
0.3	5.01E-09	3.59E-08	1.77E-07	7.98E-07	12.6
0.1	7.47E-08	5.32E-07	2.40E-06	1.07E-05	11.9

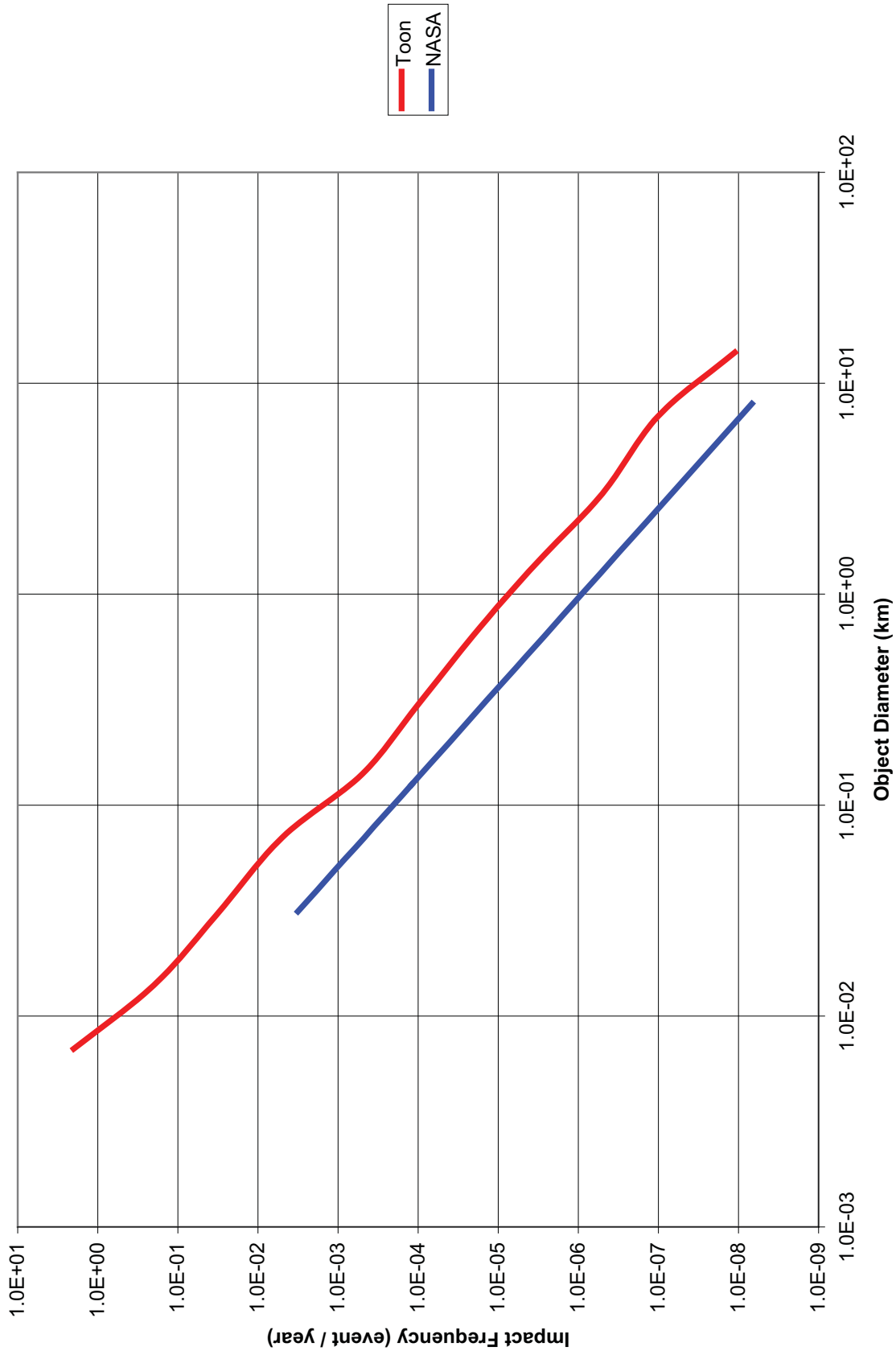

Figure 5.7-1. Earth Impact Frequency vs. Object Diameter (derived from References 5.7-1 and 5.7-2)

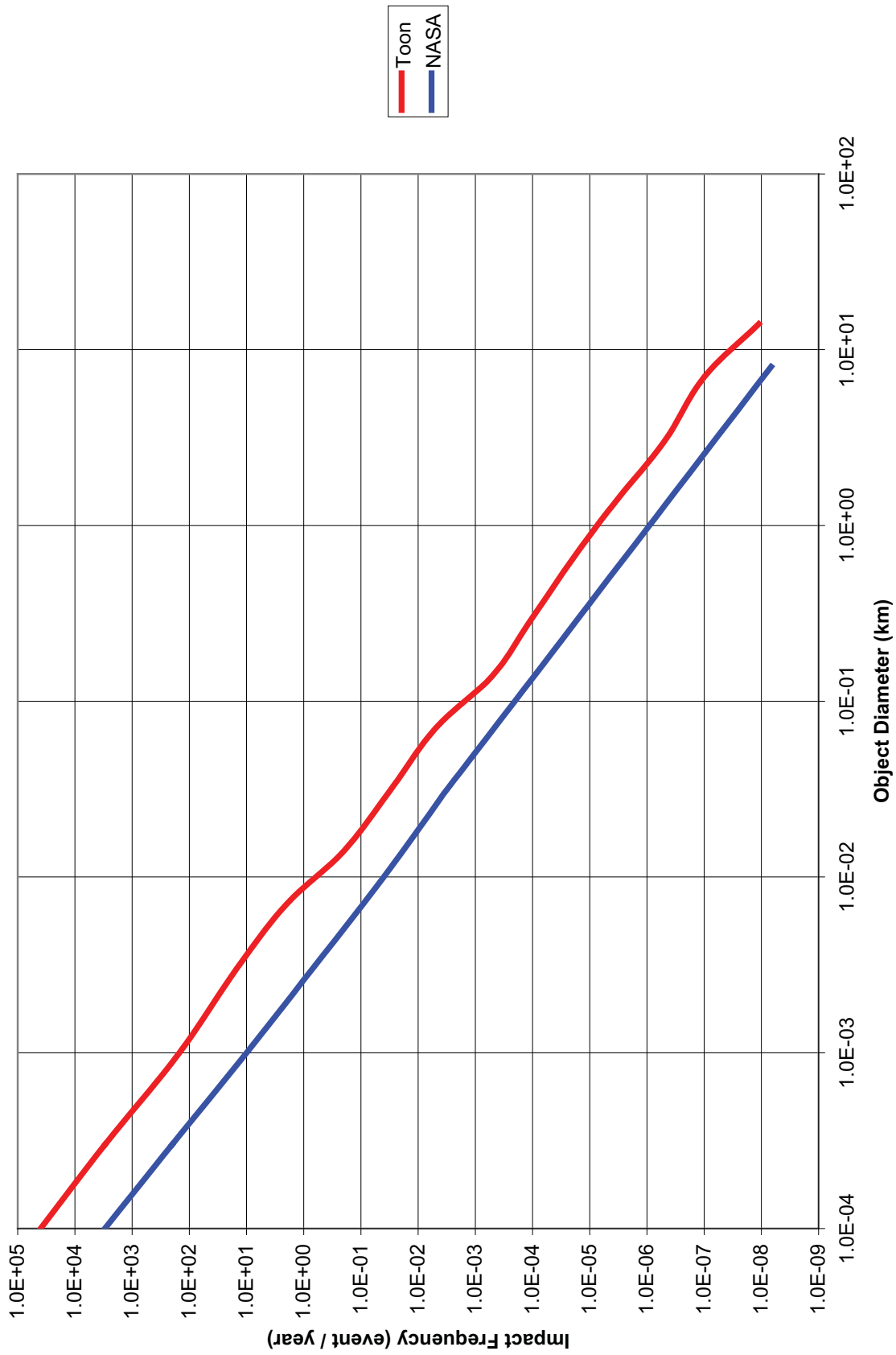

Figure 5.7-2. Earth Impact Frequency vs. Object Diameter, Extrapolated

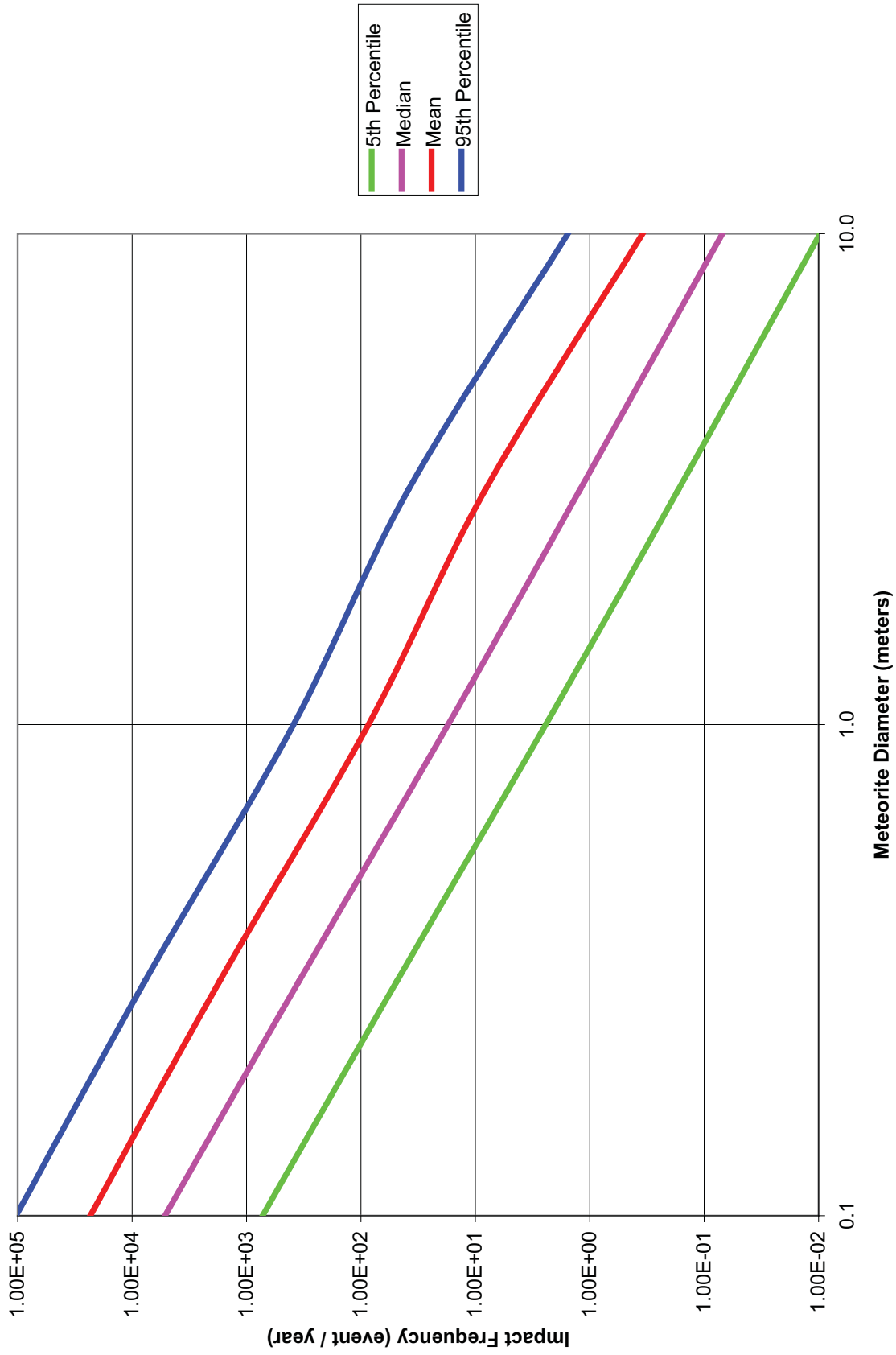

Figure 5.7-3. Earth Impact Frequency vs. Object Diameter, Composite Exceedance Curves for SDA Risk Analyses

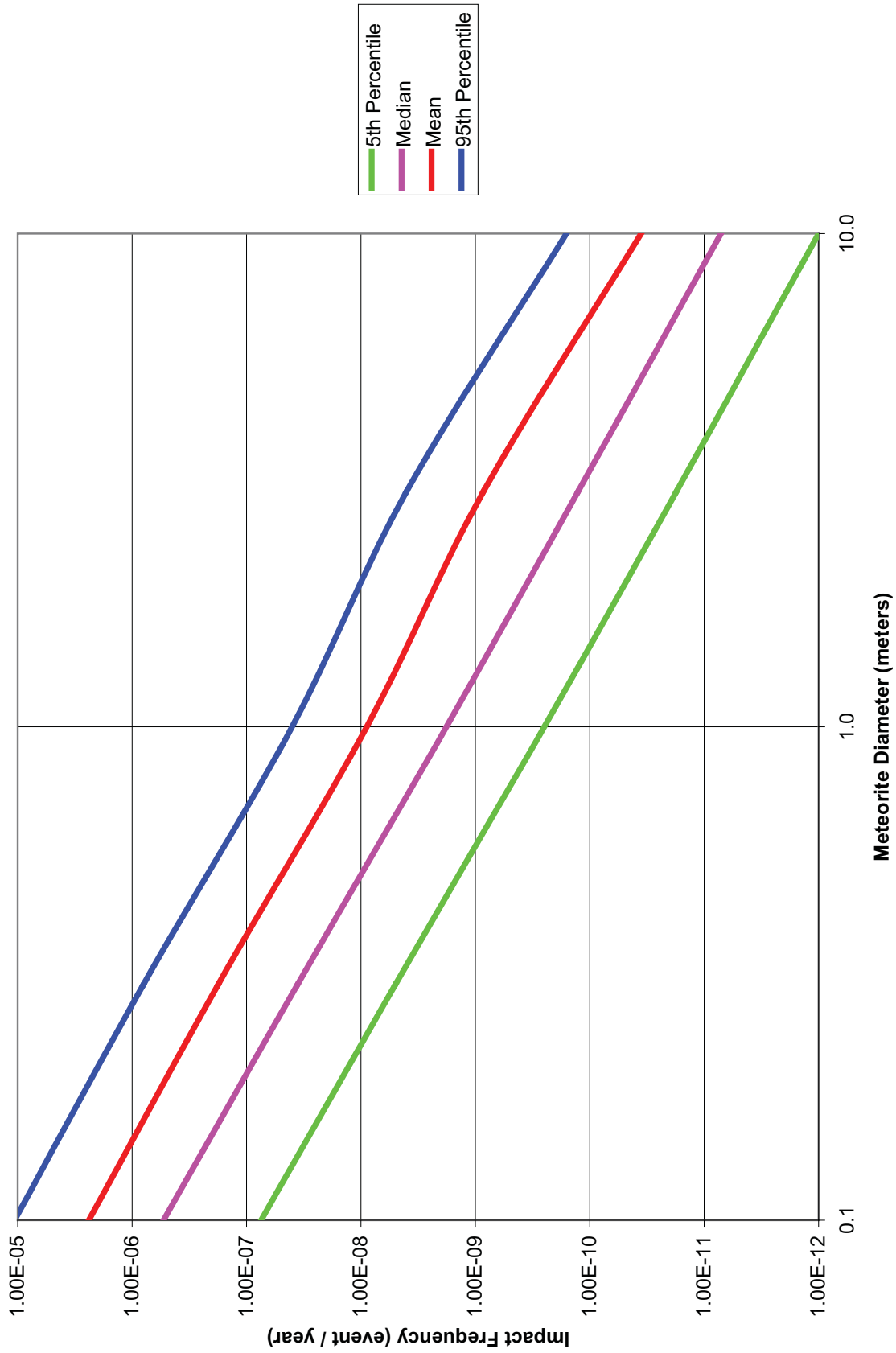

Figure 5.7-4. SDA Impact Frequency vs. Meteorite Diameter, Composite Exceedance Curves for SDA Risk Analyses

5.8 FIRES

Fires at the SDA site will not directly cause a release of waste materials from the trenches. However, fires may damage the geomembranes and increase the site vulnerability to potential impacts from subsequent flooding or water intrusion. This section describes the derivation of frequencies for wildfires that may affect the site and for fires from the gas pipeline that is routed near the northeast corner of the SDA.

5.8.1 Wildfires

The following factors affect the frequency at which a wildfire (forest fire, grass fire, etc.) may damage the SDA geomembranes.

- The frequency of wildfire ignition per unit area (e.g., event / year – mi²)
- The fire damage area (e.g., mi²)
- The SDA site area (e.g., mi²)

5.8.1.1 Wildfire Ignition Frequency

Attempts were made to collect historical data for the frequency of wildfires in the area surrounding the West Valley site. However, it was discovered that the available fire department callout records and logs do not contain enough information to clearly distinguish among the various causes, types, and sizes of fires for each response. Personnel who are familiar with two local fire districts provided the following anecdotal estimates.

- District 1 covers an area of approximately 40 square miles. The average number of grass / forest fires in a typical year is approximately 1 to 2. In some years, there are no fires. In dry years, they may experience 6 to 8 fires. The most common cause for these fires is residential open burning of trash and leaves.
- District 2 covers an area of approximately 50 square miles. The average number of grass / forest fires in a typical year is approximately 8 to 10. In dry years, they may experience 15 to 16 fires. The most common cause for these fires is residential open burning of trash and leaves.

These estimates are very approximate, and they exhibit considerable variability. However, they provide relevant information for the frequency of fires that occur in the rural areas that surround the West Valley site. These estimates were treated as follows.

- A lognormal distribution was used to characterize the uncertainty in each estimate. The average estimate was used as the median value of the distribution, and the upper estimate was used as the 95th percentile.
- The two distributions were assigned equal weights (i.e., equal credibility was assigned to each fire frequency estimate).

- The weighted distributions were merged (not added) to develop a composite frequency distribution that accounts for the combined uncertainty from both estimates.

Table 5.8-1 summarizes the results from this process. The lower bound of the composite distribution accounts for a frequency of less than one fire per year in a 50-square mile district (i.e., about 3 fires in 5 years). This is consistent with general experience during years when conditions are relatively wet. The upper bound of the distribution accounts for approximately 14 fires per year. This frequency is also generally consistent with experience from very dry years. The mean frequency corresponds to approximately 6 fires per year throughout the district.

This estimation process assumes that fires may start randomly at any location throughout the district. That assumption introduces some numerical optimism for areas near homes, businesses, and highways, where the anecdotal experience indicates that most fires originate. It introduces some numerical conservatism for remote areas where the primary fire ignition sources are natural events (e.g., lightning), downed power lines, and occasional recreational hikers and hunters.

It is difficult to determine whether the fire frequencies may change significantly during the 30-year period of this study. It is likely that the area will experience increases in population and commercial activity. These influences normally contribute to more fires. However, it is also possible that New York State will prohibit future open burning of trash, leaves, etc., which is currently a very significant contributor to the fire frequencies. Based on these counterbalancing considerations, it is judged that the historical evidence provides a reasonable basis for this study, and that the assigned frequency range adequately covers the uncertainty in these estimates.

5.8.1.2 Wildfire Damage Area

Detailed historical data are not readily available for the sizes of fires in the region surrounding the West Valley site. Table 5.8-2 summarizes a subjective distribution for fire sizes that is based primarily on discussions with NYSERDA personnel who live in the area, one of whom was a volunteer firefighter for a neighboring community.

The composite fire ignition frequency estimates from Table 5.8-1 and the fire sizes from Table 5.8-2 provide results that are quite consistent with available estimates in the general literature. For example, Reference 5.8-1 derives estimates of wildfire frequencies as a function of size for various regions of the United States. The following table compares the western New York State results from those models with the QRA study estimates for two representative fire sizes of approximately 2 acres and 2,500 acres.

Estimates of Fire Event Frequency as a Function of Fire Damage Area			
Source	Fire Damage Area (km²)	Fire Damage Area (acres)	Fire Frequency (event / year – mi²)
Reference 5.8-1	0.01	2.47	Low: 8.93E-03 Med.: 1.36E-02 High: 2.88E-02
SDA QRA	0.008	2	5th: 2.28E-03 Med.: 2.38E-02 95th: 5.60E-02
Reference 5.8-1	10	2,471	Low: 4.80E-05 Med.: 7.62E-05 High: 1.85E-04
SDA QRA	10.1	2,500	5th: 6.84E-06 Med.: 7.14E-05 95th: 1.68E-04

The geomembrane-covered area of the SDA trenches is approximately 13 acres, or approximately 2.03E-02 square miles (Reference 5.8-2). The geomembranes may be ignited if flames burn to the edge of the SDA or if flying embers land on the membranes. The fire sizes in Table 5.8-2 are interpreted as including the effects from flying embers that ignite areas at some distance from the active flame fronts. Therefore, no additional adjustment of the SDA "target area" is required for these analyses. Two conditions apply for the analysis.

Condition 1: Damage Area ≤ Site Area

If the fire damage area is less than, or equal to, the SDA site area, the frequency of fires that may ignite the geomembranes is given by:

$$F = N * S$$

where:

F = Geomembrane ignition frequency (event / year)

N = Fire frequency per unit area (event / year – mi²)

S = SDA site area (mi²)

Condition 2: Damage Area > Site Area

If the fire damage area is greater than the site area, the analysis must account for the fact that a fire may start at some distance from the SDA site and engulf the SDA area.

This analysis assumes that the SDA may be affected by any fire that starts within a distance from the site that is determined by the fire damage radius. In this analysis, the potential fire impact area (A) is determined by a circle centered on the SDA site with a radius that is equal to the fire damage radius. It is assumed that any fire that starts within this area may reach the SDA site. However, only a fraction of the fires that start within this area will actually affect the site. That fraction is determined by the ratio of the actual fire damage area (D) to the potential impact area (A).

Thus, the frequency of a fire that may affect the SDA site is given by:

$$F = (N * A) * (D / A) = N * D$$

where:

F = Geomembrane ignition frequency (event / year)

N = Fire frequency per unit area (event / year – mi²)

A = Fire potential impact area, defined by damage radius (mi²)

D = Fire damage area (mi²)

For fires where the damage area (D) is less than the SDA site area (S), the SDA site area (2.03E-02 mi²) applies for the fire damage frequency analysis. The assigned fire fraction for this impact area is the cumulative fraction of all fires with $D \leq S$. For fires where the damage area (D) is greater than the SDA site area (S), the actual damage area and its associated fire fraction apply for the damage frequency analysis. Table 5.8-3 summarizes the distribution of effective fire damage areas, derived according to this methodology.

5.8.1.3 Frequency of Wildfire Damage at SDA Site

The frequency of wildfires that may damage the SDA geomembranes was determined by multiplying the composite fire ignition frequency per unit area from Table 5.8-1 by the effective damage area distribution from Table 5.8-3. The following table summarizes the major parameters of the resulting damage frequency distribution.

SDA Wildfire Damage Frequency (event / year)			
5th Percentile	Median	Mean	95th Percentile
2.46E-04	2.61E-03	4.66E-03	7.84E-03

5.8.2 Gas Pipeline Fires

The West Valley site natural gas supply pipe is routed near the northeast corner of the SDA. The pipe originally crossed the SDA area within the site fence. However, it was re-routed when the North Disposal Area geomembranes were installed in 1995, to facilitate construction of the detention basin and drainage systems at the northeast corner of Trench 2. The original pipe enters the West Valley site property from the east, crosses Frank's Creek, and is routed to the

top of the slope, outside the east fence of the SDA. The original pipe was cut at that location, and a new pipe section was routed around the northeast corner of the SDA fence. The new pipe section reconnects to the original pipe near Erdman Brook. Based on discussions with the NYSERDA engineers, it is understood that the original pipe is steel, and the new pipe section is PVC. The pipe diameter is 6 inches, and the nominal gas supply pressure is 60 psig. The distance from the pipe to the nearest edge of the geomembrane is approximately 25 feet (Reference 5.8-3).

The following table summarizes reported failure rates for steel and PVC pipes in typical underground utility service conditions (References 5.8-4, 5.8-5, 5.8-6).

Reported Pipe Failure Rates, All Failure Modes, All Causes		
Material	Failure Rate (failures per 100 km per year)	Failure Rate (failures per 100 mi per year)
Steel	5	8
	5.3	8.5
	9.5	15.3
	14	23
PVC	4.3	6.9
	6	10
	7.3	11.8
	13	21

If these failure rates are applied to a 500-foot section of pipe (the approximate span from the top of the SDA east slope to the Erdman Brook crossing), the expected experience would be approximately one failure in 46 to 132 years for steel pipe, and one failure in 50 to 153 years for PVC pipe.

There has been historical leakage from the gas pipe, before and after installation of the new section around the SDA fence. A noticeable gas odor was present near the Erdman Brook pipe crossing when the QRA team performed a site walkdown in June 2008. This leakage experience is not necessarily unexpected, but it indicates that the effective failures rate for the gas piping in the SDA vicinity is near, or perhaps slightly higher than, the maximum values listed above. The historical persistence of gas leaks in this area also indicates that site management may not aggressively pursue repairs of the pipe, if the supply pressure remains acceptable at the main facility pressure reduction station on the North Plateau.

Of course, potential fires from gas leaks in this area also require an ignition source. No electrically operated equipment or power lines are located in this area of the site. With the exception of security patrols, personnel enter the area very infrequently, limited primarily to periodic inspections of the geomembranes and drainage systems, monitoring of the site wells and sample stations, etc. Other potential ignition sources include lightning strikes and grass or forest fires that propagate from surrounding areas. (These other fires also represent a direct threat for geomembrane ignition, as evaluated in Section 5.8.1.)

It is extremely difficult to estimate the likelihood that a gas pipeline fire may occur in this area of the SDA at some time during the 30-year period of this study. It is evident that the piping in this area cannot be characterized by the performance of "typical" utility service installations, due to the noted historical experience. However, current practices and experience also indicate that the likelihood of potential ignition sources in this particular area of the site is quite small. The following subjective uncertainty distribution is used to estimate the likelihood of these fires.

Subjective Likelihood of Gas Pipeline Fire in SDA Vicinity At Some Time in the Next 30 Years				
5th Percentile	Median	95th Percentile	Mean	Error Factor
1.00E-03	1.00E-02	1.00E-01	2.66E-02	10

This distribution represents the following judgments.

- If there are 1,000 similar site configurations that each operate for 30 years, there is 95% probability that a fire will occur in one or more of them.
- If there are 1,000 similar site configurations that each operate for 30 years, there is 95% probability that a fire will occur in 100 or fewer of them.

Thus, if there are 1,000 similar site configurations that each operate for 30 years, there is 90% confidence that a fire will occur in more than 1 and less than 100 of them. The expected (mean) number of fires is about 27 in the entire population of 1,000 sites.

The upper and lower bounds of this distribution are also numerically consistent with the following SDA-specific considerations.

- The lower bound is approximately equal to the fire frequency that would be estimated by using the lowest piping failure rate for a "typical" installation (i.e., 6.9 failures in 100 piping miles per year), a 500-foot section of pipe, and assuming that ignition occurs during 1 in 200 of those leaks [$30 * 6.9 * (500 / 528,000) * (1 / 200) = 9.8E-04$]. It effectively accounts for improved inspection and maintenance of the gas pipe according to "typical" installation practices over the next 30 years.
- The upper bound is approximately equal to the value that would be estimated by assuming that a gas leak persists in this area of the SDA approximately 50% of the time, and assuming that ignition occurs during 1 in 150 of those leaks [$30 * 0.5 * (1 / 150) = 0.10$]. It effectively accounts for conditions that are somewhat worse than the historical experience with respect to inspection and maintenance of the gas pipe. It also accounts for the possibility that ignition sources may be introduced more frequently by increased activities associated with decommissioning and remediation work in adjacent areas of the site.

It is reasonable to assume that the pipeline fires may occur randomly throughout the 30-year exposure period. Therefore, these estimates are equivalent to the following annual fire frequencies.

Subjective Frequency of Gas Pipeline Fires in SDA Vicinity (event / year)				
5th Percentile	Median	95th Percentile	Mean	Error Factor
3.33E-05	3.33E-04	3.33E-03	8.87E-04	10

5.8.3 References

- 5.8-1. "Characterizing Wildfire Regimes in the United States", Malamud, B. D., J. D. A. Millington, and G. L. W. Perry, *Proceedings of the National Academy of Sciences*, 102, 13, 4694–4699, March 2005
- 5.8-2. E-mail communication, M. R. Weishan, NYSERDA, to J. W. Stetkar, June 2, 2008
- 5.8-3. E-mail communication, M. R. Weishan, NYSERDA, to J. W. Stetkar, July 31, 2008
- 5.8-4. "6th EGIG-report 1970 – 2004, Gas Pipeline Incidents", EGIG 05.R.0002, 6th Report of the European Gas Pipeline Incident Data Group, Groningen, Netherlands, December 2005
- 5.8-5. "Polyethylene Pipes: Network Performance", Australian Commonwealth Scientific and Industrial Research Organization (CSIRO), presented at Plastics Industry Pipe Association (PIPA) Seminar, Melbourne, Australia, September 2007
- 5.8-6. "UKWIR National Mains Failure Database", MacKellar, S., Bodycote PDL, Manchester, UK, presented at Plastics Industry Pipe Association (PIPA) Seminar, Melbourne, Australia, September 2007

Table 5.8-1. Wildfire Ignition Frequency Estimates							
Source	Estimated Value	5th Percentile	Median	Mean	95th Percentile	Error Factor	
District 1	Fire Frequency (fires / year – mi ²)	8.03E-03	3.75E-02	5.82E-02	1.75E-01	4.67	
	Fires per Year in District (40 mi ²)	0.3	1.5	2.3	7.0		
District 2	Fire Frequency (fires / year – mi ²)	1.05E-01	1.80E-01	1.90E-01	3.10E-01	1.72	
	Fires per Year in District (50 mi ²)	5.3	9.0	9.5	15.5		
Composite	Fire Frequency (fires / year – mi ²)	1.14E-02	1.19E-01	1.24E-01	2.80E-01	4.96	
	Fires per Year in 50 mi ²	0.6	6.0	6.2	14.0		

Table 5.8-2. Estimated Distribution of Wildfire Sizes			
Damage Area (acres)	Damage Area (mi²)	Fraction of Fires	Cumulative Fraction
0.5	7.81E-04	0.3000	0.3000
1	1.56E-03	0.2000	0.5000
2	3.13E-03	0.2000	0.7000
5	7.81E-03	0.1000	0.8000
10	1.56E-02	0.1000	0.9000
25	3.91E-02	0.0500	0.9500
50	7.81E-02	0.0300	0.9800
100	1.56E-01	0.0120	0.9920
500	7.81E-01	0.0050	0.9970
1,000	1.56	0.0020	0.9990
2,500	3.91	0.0006	0.9996
5,000	7.81	0.0003	0.9999
10,000	15.6	0.0001	1.0000

Table 5.8-3. Effective Damage Area for SDA Analyses	
Damage Area (mi²)	Fraction of Fires
2.03E-02	0.9000
3.91E-02	0.0500
7.81E-02	0.0300
1.56E-01	0.0120
7.81E-01	0.0050
1.56	0.0020
3.91	0.0006
7.81	0.0003
15.6	0.0001

SECTION 6

FRAGILITY ANALYSIS

Fragility analyses are performed to evaluate the conditional likelihood that a particular type of damage may occur as a consequence of a disruptive event or an evolving process. Several of the fragility analyses for this study benefited substantially from input by an expert panel that advised the QRA team on specific technical issues.

Section 6.1 provides a general overview of the expert elicitations. Section 6.2 summarizes analyses of potential earthquake damage to the slopes at the north and east sides of the SDA. Section 6.3 evaluates potential landslides that may occur as a consequence of conditions other than seismic-induced failures. Section 6.4 describes analyses of potential trench cap erosion if severe precipitation occurs, and the geomembranes are not intact. Section 6.4 also evaluates potential slope gully erosion as a consequence of severe precipitation events. Section 6.5 describes the recommended methods and analytical models that were used to evaluate groundwater flows at the site. Section 6.6 summarizes analyses that determine the amount of precipitation that is required to fill the waste trenches and the volume of liquid that is released if the trenches overflow. Section 6.7 describes analyses that evaluate the likelihood for various water levels in the trenches during the 30-year study period.

6.1 EXPERT ELICITATIONS

Risk analysts often encounter situations where the availability of relevant experience data is extremely limited, there are multiple possible interpretations of the same data, diverse methods and models are available to evaluate physical and phenomenological performance of complex systems, there is limited validation of the models, and differences in the model results have a potentially significant impact on the quantified risk. In these instances, a structured elicitation of expert judgment provides an established method to evaluate the technical community's current state of knowledge, including a systematic assessment of the associated uncertainties.

6.1.1 Elicitation Sessions

A 3-day meeting was conducted at the NYSERDA offices on July 21 – 23, 2008. The purpose of this meeting was to elicit expert input, guidance, and recommendations for the analyses of several key technical issues in the SDA risk assessment models. The experts were selected based on their demonstrated expertise in the required technical disciplines, their personal knowledge of the West Valley site and the SDA, and their familiarity with available site-specific analyses for these issues.

Prior to the meeting, the experts were provided with the elicitation methodology summary in Appendix 6.1A. They were encouraged to read the sections regarding representation of the engineering community's state of knowledge and the types of uncertainties that may affect their recommendations or conclusions. These topics were also reviewed at the start of the meeting.

Due to the very limited time that was available, the meetings were conducted semi-formally. Members of the QRA team were present to describe each technical concern and to explain how it affects the risk assessment models. The discussions were also monitored and moderated by an expert who is familiar with the technical issues and who has had previous experience in large-scale formal elicitations. That person and the QRA team members provided limited Technical Facilitator / Integrator functions during the group discussions. All experts provided their final recommendations and input to the QRA team in written reports, with occasional interim consultations to discuss specific issues.

6.1.2 Participating Experts

The following experts provided the primary technical resources during the meeting.

Dr. Sean J. Bennett
Professor of Geography
State University of New York at Buffalo

Dr. Shlomo P. Neuman
Regents' Professor, Department of Hydrology and Water Resources
University of Arizona

Dr. Robert H. Fakundiny
New York State Geologist, Emeritus
Former Chief of the New York State Geological Survey

Dr. Michael P. Wilson
Professor of Geology
State University of New York at Fredonia

Dr. Peter N. Swift of Sandia National Laboratory provided supplementary technical input on selected topics. Dr. Swift attended the sessions during all 3 days, and he provided consistency for the Technical Facilitator / Integrator (TFI) role during the discussions.

Dr. B. John Garrick, Study Director, and Mr. John W. Stetkar, Principal Investigator, of the QRA team participated in the sessions on July 21 and 22, but could not attend on July 23 due to schedule conflicts. They defined the technical issues to be addressed by the experts, explained how the issues affect the SDA risk assessment models, and performed supplementary TFI functions to focus specific technical discussions.

Mr. Stephen L. Wampler of the QRA team participated intermittently by teleconference and provided information and analyses to support the slope stability evaluations.

NYSERDA was represented at the meetings by Mr. Thomas H. Attridge, Program Manager, and Mr. Paul J. Bembia, Program Director. Mr. Bembia attended only on July 23, due to schedule conflicts. They provided site-specific input for selected technical issues and supporting analyses.

6.1.3 Elicitation Process

It quickly became evident that achievement of group consensus was neither necessary nor technically justified for most of the issues. The experts agreed that individuals within the group had primary knowledge and expertise for specific technical topics and would serve as the lead resource for those issues. Each issue was discussed extensively by the group, to ensure that any specific concerns and supplementary information were appropriately considered by the lead expert.

After considerable discussion, the entire group developed a consensus position on the issue of trench water levels to be used during the 30-year study period.

6.1.4 Evaluated Issues

The following sections briefly summarize the specific technical issues that were evaluated by the experts.

6.1.4.1 Trench Water Levels

Water levels in the trenches are an important input to several analyses in this study. Therefore, as part of their deliberations, the experts developed probabilities for a range of possible levels. The experts' assessments were based on several assumptions regarding the fraction of time that the geomembranes may be removed from the trenches and the likelihood that precipitation at the site would fill the trenches. These initial estimates were subsequently refined by the analyses that are described in Section 6.7.

6.1.4.2 Non-Seismic Landslides

Dr. Robert H. Fakundiny and Dr. Michael P. Wilson were identified as the lead experts for this issue. They evaluated local landslides that may affect the slopes along Erdman Brook and Frank's Creek, and much larger regionally disruptive landslides that may affect portions of the Buttermilk Creek basin adjacent to the SDA. Their input is documented in Section 6.3.

6.1.4.3 Overland Flow and Surface Runoff

Dr. Sean J. Bennett was identified as the lead expert for this issue. He evaluated the effects from parallel and perpendicular flows that may erode the compacted clay caps over the waste trenches, if precipitation occurs while the geomembranes are not intact. His models and analyses are documented in Section 6.4.

6.1.4.4 Stream Bank and Gully Erosion

Dr. Sean J. Bennett was identified as the lead expert for this issue. He evaluated the effects from rapid migration of existing gullies in the slopes along Erdman Brook and Frank's Creek, as a function of precipitation rates. His models and analyses are documented in Section 6.4.

6.1.4.5 Groundwater Flows and Pathways

Dr. Shlomo P. Neuman was identified as the lead expert for this issue. He provided a methodology and analytical models to evaluate groundwater flows through the WLT, ULT, and Kent Recessional soil layers, as a function of time and water levels in the waste trenches. His models are documented in Section 6.5.

6.1.5 Additional Expert Consultations

Additional experts were consulted on the following technical issues. The experts provided their opinions, guidance, and recommendations via telephone conferences and e-mail exchanges.

Trench Waste Characterization

Dr. Michael T. Ryan
Chairman, U.S. Nuclear Regulatory Commission Advisory Committee on Nuclear Waste

Dr. Ryan provided background information and guidance about the likely physical conditions of trench waste materials and the mobility of specific radionuclide species. This information supported the release categorization analyses.

Seismic Hazard

Dr. Klaus H. Jacob
Senior Research Scientist, Seismology, Lamont-Doherty Earth Observatory
Adjunct Professor of International and Public Affairs
Columbia University

Dr. Jacob provided background information regarding the general shapes of seismic hazard curves and associated uncertainties for regions in the Northeast United States. He also

compared the current United States Geological Survey seismic hazard estimates with the previous hazard analyses for the West Valley site. This information supported the seismic hazard analyses.

Intervention and Mitigation Measures

NYSERDA engineering team

The SDA risk assessment includes credit for NYSERDA responses to intervene and mitigate the potential consequences from a variety of adverse conditions. The scope of this study is limited to the evaluation of mitigation responses that prevent releases from the trenches or stop a continuing release into the surrounding environment. To best account for the NYSERDA team's experience and their understanding of the integrated mitigation requirements, the NYSERDA engineers were asked to evaluate six potential SDA damage scenarios. In particular, they were asked to describe the activities that are necessary to achieve the desired mitigation goal for each scenario and to provide "best", "upper bound", and "lower bound" estimates for the amount of time that may be required to complete each phase of the mitigation plan. This information supported vulnerability assessments and analyses of threat exposure times for several release scenarios.

APPENDIX 6.1A

EXPERT ELICITATION METHODOLOGY

Expert elicitation has been used in quantitative risk assessment for more than 30 years. Significant advances in a structured elicitation methodology were first applied during U. S. Nuclear Regulatory Commission (NRC) analyses to support NUREG-1150 (References 6.1A-1 and 6.1A-2). Current applications of expert elicitation support key inputs to seismic hazard evaluations (References 6.1A-3 and 6.1A-4), characterization of the Yucca Mountain waste repository (Reference 6.1A-5), analyses of human performance (References 6.1A-6 and 6.1A-7), and estimation of nuclear power plant loss of coolant accident (LOCA) frequencies (Reference 6.1A-8).

The need for refined and updated elicitation methods was recognized through practical experience from the NUREG-1150 applications and evaluations of seismic hazards performed by Lawrence Livermore National Laboratory (LLNL) and the Electric Power Research Institute (EPRI) in the late 1980s. To provide technical guidance on a methodology for Probabilistic Seismic Hazard Analysis (PSHA), a Senior Seismic Hazard Analysis Committee (SSHAC) was formed in 1993 under three-way sponsorship of the U. S. Department of Energy (DOE), the NRC, and EPRI. The SSHAC-recommended expert elicitation methodology is documented in Chapter 3 and Appendix J of NUREG/CR-6372 (Reference 6.1A-3). Although the report contains many recommendations that are specific to PSHA, the general methodology is valid for any application.

6.1A.1 Study Level and Role of Technical Integrator

The guidance in NUREG/CR-6372 summarizes a range of possible study levels that depend on issues such as complexity of the technical concern, the level of uncertainty, the degree of contention within the technical community, potential significance to the risk results, and project budget and schedule considerations. In the context of the NUREG/CR-6372 hierarchy, the expert elicitations conducted for this study are generally characterized as a simplified application of a Level 3 study, using a Technical Facilitator / Integrator (TFI). The key participants in this process are:

- A panel of experts who act as informed evaluators of a range of hypotheses and models, and provide an integrated representation of the position of the technical community as a whole
- A TFI who facilitates the discussions and interactions among the experts, and is responsible for aggregating the panel's judgments and distributions to develop the composite results that are used in the risk assessment

6.1A.2 Types of Experts

Experts are generally characterized as "proponents", "evaluators", or "resource experts". These classifications are convenient to distinguish the experts' expected roles during the elicitation process, but they are not necessarily mutually exclusive.

- A **proponent** is an expert who advocates a particular hypothesis or technical position. The proponent role is common in science, whereby an individual evaluates data and develops a particular hypothesis to explain the data. The proponent's position is then challenged technically by his peers in professional debates and in the literature to see if it stands up to a variety of observations. The proponent of the hypothesis detaches himself professionally from the success or failure of the hypothesis; that is, although he argues for the viability of the hypothesis, he recognizes that it may ultimately be proven wrong. With time, the hypothesis will gain increasing support with additional data or will lose favor in the scientific community.
- An **evaluator** is an expert who is capable of evaluating the relative credibility of multiple alternative hypotheses to explain the observations. The evaluators are expected to evaluate all potential hypotheses and bases of inputs from proponents and resource experts and provide 1) their own input and 2) their representation of the community distribution. The evaluator recognizes that the evaluation occurs at a particular point in time and, as a result, the viability of any particular hypothesis is uncertain and may not be proven until some time in the future. To evaluate the alternatives, the evaluator considers the available data, listens to proponents and other evaluators, questions the technical basis for their conclusions, and challenges the proponents' positions. In the end, the evaluator is able to assign relative credibilities to the alternative hypotheses. He recognizes, too, that no single hypothesis is likely to be the ultimate truth – it is only a current representation. Therefore, for example, he may assign a smooth continuous uncertainty distribution for a parameter to which each hypothesis (model / interpretation / data set) assigns a unique value, and for which a finite set of weighted hypotheses would imply discrete results.
- A **resource expert** is a technical expert with specialized knowledge of a particular data set of importance to the analyses. Commonly, a resource expert will have site-specific experience that will be of use to the evaluators. For example, a resource expert for a site-specific seismic hazard analysis might be a geologist who has mapped and evaluated nearby faults. A resource expert might also have expertise in particular methodologies or computational tools of use to the evaluators.

Due to practical limitations, it is important that the experts in the elicitation process for this study fulfill the roles of both evaluators and resource experts. They must be experts who are directly familiar with the issues, methods, and models that apply specifically to conditions at the SDA, and they must be able to represent the spectrum of experience from the technical community as a whole. An important role of the TFI is to be aware that an individual expert may also be a proponent of a particular technical position, and to ensure that the panel discussions and final results appropriately account for that possibility.

6.1A.3 Objectives of the Elicitation Process

Figure 6.1A-1 is reproduced from NUREG/CR-6372 Figure 3-1. It illustrates the possible outcomes of the elicitation process in a logic tree format. Reading from left to right, the tree indicates increasingly less desirable final process outcomes. Paths with an arrowhead indicate desirable (and expected) outcomes. The TFI's job is to organize a process that will exit the tree at the earliest possible point, while at the same time making sure that this is a legitimate stopping point.

The fundamental objective of the elicitation process is to use the panel to represent the overall scientific community's state of knowledge. The underlying premise is that the primary objective for public policy making is not capturing the judgment of any individual expert, nor even capturing the composite judgment of any specific subset of experts, but rather, capturing as best possible the composite judgment of the overall scientific community of informed experts. Characterizing the panel's own knowledge is an essential intermediate goal, but not the final product of the process. Of course, it is impractical to engage an entire scientific community in any meaningful interactive process. Decision makers must always rely on a smaller, but representative, set of experts. Thus, the panel is viewed as a sample of the overall expert community.

The following possible outcomes from Figure 6.1A-1 illustrate how this objective is achieved in practice, and they provide a framework for interactions among the experts and the TFI. These summaries are for the most part excerpted directly from NUREG/CR-6372 Section 3.3.3.

6.1A.3.1 Outcome 1: Consensus

The most desirable end state is consensus among the expert panel, but only if the experts truly agree after a full and intensive information exchange and interaction. There are two equally inappropriate outcomes the TFI must avoid: 1) the group achieving an artificial consensus that is not real (unintentional agreement) and 2) the group appearing to have substantial disagreements that are caused only by semantics and confusion rather than by substantive scientific differences (unintentional disagreement).

A key question that must first be addressed is, "Consensus on what?" Consider the following possible types of consensus.

Consensus Type 1

Each expert believes in the same deterministic model or the same value for a variable or model parameter.

This could reflect agreement on a scalar parameter like the speed of light or density of the Earth's crust, or agreement on a deterministic model and its parameters (e.g., ground motion attenuation as a function of distance), or sometimes just agreement on a functional form (e.g., the attenuation curve is logarithmic). Importantly, this could reflect agreement within practical limits such that the final results are insensitive to differences. This type of technical consensus represents the common use and meaning of the word, but is often an artificial objective and difficult to achieve.

Consensus Type 2

Each expert believes in the same probability distribution for an uncertain variable or model parameter.

This could reflect agreement about a probability judgment, the probability distribution resulting from a single model, or agreement on appropriate weights for a range of probabilistic models or positions. This type of technical consensus is also difficult to reach, but may be achievable for some issues after removal of unintentional differences by an appropriately facilitated process.

Consensus Type 3

All experts agree that a particular composite probability distribution represents them as a group.

Note that a group may agree on their composite representation, even if individuals have different positions. This type of consensus is generally easier to achieve than Types 1 and 2, especially if the experts recognize that substantial diversity among individual panel estimates tends to imply a wide range of overall uncertainty.

Consensus Type 4

All experts agree that a particular composite probability distribution represents the overall scientific community.

The SSHAC methodology seeks Type 4 consensus, which is potentially the easiest type of consensus to achieve. In the process of seeking Type 4 consensus, a useful intermediate step is to seek Type 3 consensus.

There is reason to be far more optimistic that the process can achieve legitimate Type 3 or 4 representational consensus than one would be for an expert panel to achieve more traditional Type 1 or 2 technical consensus. In this process, the fundamental goal is not consensus on scientific issues, which is almost impossible to achieve. Acting as evaluators and integrators, the experts only have to agree on the appropriate composite representation of the overall scientific community. Practical implementation of this process has shown that it is usually far easier for a group of experts – when they have legitimate scientific disagreements – to agree on how to represent the informed community's legitimate diversity of opinion about a technical issue, than it is for the experts themselves to agree on specific elements of that issue.

6.1A.3.2 Outcome 2: Equal Weights

When the panel members do not share the same composite representation of the community, the TFI must define the composite distribution. The TFI is neither constrained to use any fixed aggregation formula nor, in particular, to weight all expert inputs equally. Nevertheless, equal weighting has significant advantages, and the elicitation process is explicitly designed to create conditions under which equal weights will be appropriate. The attraction of equally weighting expert judgments is that it avoids at least two extremely difficult issues. First, one need not make what can be a very charged – and difficult to defend in the regulatory arena – judgment ("Who is the best expert?"), and second, one need not make what can be very difficult assessments ("If not equal weights, what?").

It is essential for the TFI to understand clearly when equal weights are appropriate, and when they are not. Intensive interaction is perhaps the most effective way to create conditions under which equal weights are appropriate. In past studies, equal weights were often used without this intensive interaction and without careful analysis of whether equal weights were appropriate. This can be dangerous for some technical issues, especially when equally weighting an indefensibly high probability given by one "outlier" expert can (as it has in some studies) swamp out the impact of all the other experts. The result is an answer that no one, not even the outlying expert, believes is representative of the overall community.

There are three conditions that must hold for equal weighting to be appropriate.

- The experts must either be completely independent (i.e., rely on independent data bases and models; which, in practice, is virtually impossible), or the experts must be equally interdependent. By exposing the expert panel to all models and databases, the elicitation process encourages equal interdependence.
- The experts must be equally credible. During the selection process, the experts should be methodically screened for their ability to be excellent scientific evaluators.
- The experts must represent an unbiased sample of the overall expert technical community.

The third condition arises from the fundamental objective to derive results that represent the state of knowledge of the overall technical community. Suppose, for example, an expert evaluator insists on giving credence to only one model, thereby acting as a proponent rather than an informed evaluator. If that expert is given equal weight among the experts on the panel, the aggregation process would over-represent the strength of his or her position in the community. For example, suppose that the panel contains N experts, and each is assigned an equal weight. The proponent's weight would thus be $1/N$. Now, suppose that the panel could be expanded to the size of the entire community by adding X new experts (i.e., the size of the community is $N+X$). If the original $N-1$ representative experts on the panel are replicated by the new experts, the proponent would still be the only one holding his or her position. Thus, the appropriate weight for the proponent should be $1/(N+X)$.

This numerical difference may seem quite significant. However, in practice, it should be noted that changing an individual expert's weight from $1/N$ may or may not affect the composite representation significantly, depending on how strongly the estimate based on his or her position deviates from the estimate based on the distribution from the other $N-1$ experts. For example, there is no reason to down-weight an expert's composite representation if the final answer is insensitive to the weight given to his or her position. If the expert's answer is not dramatically different than the average of the other positions, or if it results in a slightly lower-than-average probability, then it will likely not have an appreciable effect on the overall results, especially the mean value. In this case, even if the TFI feels an expert's position is "over-represented" by an equal weight, it is not worth the time, energy, and possible controversy involved to down-weight that expert.

In summary, it is important to select a diverse group of experts, large enough to ensure that all credible points of view are represented, including all fundamental interpretations and modeling approaches. Using equal weights implicitly assumes that each expert is "standing in" for a much larger community of equally qualified experts. Thus, it is important that the set of experts be capable of representing the overall expert community as a whole.

6.1A.3.3 Outcome 3: Explicit Quantitative Weights

In any practical project, the number of experts (e.g., N) is small relative to the larger population of equally qualified experts. The TFI may believe that if the panel were expanded to the size of the overall community, an expert's position would not be representative of $1/N$ of the community. Then to give that expert's position a weight $1/N$ would misrepresent the diversity in the overall community. In this case, unequal weighting may be appropriate. The situation need not be contentious, and it should be viewed as primarily a process issue. The relevant question

is, "Is the expert's position, which is already a weighted combination of models, representative?" not the more personally threatening question, "Is the expert's scientific position correct?" In the rare case in which this issue arises, the expert should be given every opportunity to defend his or her position as being representative to the other experts and peer reviewers.

The issue of "outlier" experts has been especially contentious in past multiple-expert studies. An outlier expert is defined by two conditions: a) he or she makes an interpretation far different than the rest of the panel and b) the expert cannot support the interpretation with solid data or reasoning (from the points of view of the TFI and the other panel members). For example, a past PSHA study included an expert who attached probability of unity to Modified Mercalli Intensity (MMI) XII earthquakes throughout the Northwestern U.S. If the study objective were limited to developing a composite representation of, say, a five-person panel, then the TFI is in a logical "trap" since the outlier expert does, in fact, represent 1/5 of the panel. Moreover, the outlier expert was selected carefully as being *a priori* as equally qualified as the other experts. Common sense says that the MMI XII expert should be down-weighted, but how can this be justified after the fact without superimposing the TFI's own scientific judgment on the process?

The perspective of developing a composite representation of the overall community of scientists affords a way out of the logical trap. When asked to identify other supportive experts, the outlier may even agree that he or she is the only one out of a hundred seismicity experts who would attach significant probability to a MMI XII earthquake. Thus, to represent the overall community, if we wish to treat the outlier's opinion as equally credible to the other panelists, the TFI might properly assign a weight of 1/100 to his or her position, not 1/5.

6.1A.3.4 Outcome 4: "Weighing" rather than "Weighting"

Rarely, even after extensive interaction, will a situation call for some type of asymmetric treatment of expert-as-integrator representations. More commonly (but still relatively rare), the experts themselves, in their role as evaluators of models or proponent positions, may find simple fixed numerical weights to be inadequate. An example is in the ground motion arena, in which many experts believe that the weights on different models should be a function of magnitude, frequency, and distance. But there are even rarer situations in which explicit model weighting of any type is artificial, in which case an expert must "weigh" alternative models in a more general sense. A simple example will help to explain this concept. Two proponents have provided a TFI with their probability distributions on a scalar quantity y . These cumulative distribution functions (CDFs) are shown in Figure 6.1A-2. The experts A and B have also supplied the reasoning (qualitative arguments) underlying their CDFs. If the TFI is constrained to use equal weights, he or she will do what the NUREG-1150 methodology required (Reference 6.1A-1) and will produce the curve labeled EW. For each value of y , the EW ordinate is one-half the sum of the ordinates of the curves A and B. The qualitative arguments that the experts have supplied play no role in this aggregation scheme, except, perhaps, to give legitimacy to the individual distributions.

Suppose now that the TFI studies these arguments carefully and finds that the reason why the two curves differ is the disputed applicability of a piece of evidence: Expert A believes that this evidence is convincing, while Expert B believes that it is not relevant. The experts are fully aware of this disagreement, and have discussed each other's rationales, but they are not willing to change their curves. Let us further assume that the TFI reaches the conclusion, based on the experts' interpretations, that the disputed evidence is most likely irrelevant at very low

values of y , but cannot be completely dismissed for moderate values. The TFI, therefore, produces the curve labeled "TFI" to reflect this state of knowledge. This curve is presented to the experts and their subsequent arguments are evaluated by the TFI who may adjust the composite curve to reflect this feedback. Finally, the TFI reports the composite curve and the reasons that have led to its derivation (which, of course, includes reporting the individual curves and arguments, so that others may judge the validity of the whole exercise). It is easy to see why requiring the TFI to use explicit weights for this aggregation scheme would be artificial. Furthermore, this approach can mitigate contention based on different parties' complaints that their positions were not understood, because the explicit issues will have been explained and the TFI's reasoning documented, so that discussions on the merits can occur in an open context.

6.1A.4 Role of the Technical Facilitator / Integrator (TFI)

The NUREG/CR-6372 methodology introduces and formalizes the role of a Technical Facilitator / Integrator. In contrast with the classical role of experts on a panel as individuals providing inputs to a separate aggregation process, the panel is viewed as a team, with the TFI as team leader, working together to arrive at, first, a composite representation of the knowledge of the group and, second, a composite representation of the knowledge of the technical community at large. The process is transparent to the experts at all stages, in contrast with previous studies in which some experts have complained that the aggregation process was a "black box". The TFI conducts individual elicitations and group interactions, and with the help of the experts themselves, integrates data, models, and interpretations to arrive at the final product – a full probabilistic characterization of the evaluation results. Together with the experts, the TFI "owns" the study and defends it as appropriate.

The TFI has two primary roles.

- **Facilitator:** Structures and documents information, data, and judgment exchange; stages effective, professional face-to-face debates and interactions in critical areas; ensures that the group identifies all strengths and weaknesses of key data and modeling approaches; elicits formal evaluations from each expert; creates conditions that enable a direct, non-controversial integration of the experts' judgments.
- **Integrator:** Develops a final composite assessment (e.g., explicit probability distributions that can be used in the risk assessment models); explains and defends this assessment before the panel; obtains feedback and concurrence (to the maximum degree possible); explains and defends the composite representation to the outside community (e.g., other experts, peer reviewers, and all other interested parties).

The TFI must have the stature and expertise to deal authoritatively with the multiplicity of disciplines and individuals. It is rare that one person will possess all of the required qualities. Thus, "the TFI" will often consist of a small group of individuals, typically two or three. At least one individual should have "substantive" knowledge of the subject matter. As a "specialist", he or she should be at least as qualified as the members of the panel on the technical issues. Another role (often another individual) will be that of a "risk expert" who knows how the risk assessment models work and how the experts' inputs might affect the final results. Finally, one member of the TFI team should be an "elicitation" expert (sometimes called a "normative"

expert); i.e., an expert on individual and multiple-expert elicitation processes, as well as in decision analysis and probability theory, especially on methods for processing evidence.

Principles that guide the TFI in conducting the elicitation process include:

- **Experts as Evaluators, not Proponents:** Viewing the experts as evaluators who provide interpretations of a range of data and models is an attractive alternative, compared to viewing the experts as proponents who advocate their own models or assessments. Although the TFI might sometimes ask a panel expert to act temporarily as a proponent, this is solely for the purpose of explaining a particular model, not for the purpose of creating a permanent advocate.
- **Emphasis on Expert Interaction:** The TFI must conduct structured, facilitated discussions among the panel experts in which the focus is on underlying models and hypotheses, not on individual experts. The process evolves in stages, and in each stage there are intensive group interactions preceded and succeeded by TFI interaction with individual experts.
- **Isolate Sources of Disagreements:** Experts may disagree about underlying scientific hypotheses and principles; about interpretations of different available data sets; about the values of model parameters; and, even with agreement on models, data, and parameter values, about the ranges of the epistemic uncertainties that affect the results. Paradoxically, isolating and focusing discussion about the different potential types of disagreement may actually move the group toward agreement on specific issues. For example, the process of isolating sources of disagreement often uncovers many common points of agreement and reveals points of unintended disagreement.
- **Active Listening:** A useful facilitation model is the concept of "active listening," in which a person's reasoning is not considered fully understood unless each listener, whether or not they agree with the reasoning, can explain it back to the person who made the point. It is extremely important for the TFI to summarize points of agreement and disagreement, encourage active listening, and frequently play back a clear summary of the conversation during the meeting.
- **Tone of the Interaction:** It is critical for the TFI as a facilitator to set the right tone. Two elements are critical: first, establish that the purpose is not to choose the best model or answer. The TFI concept is founded on the premise that there is no one correct model or answer, no single "winner" or "loser". Second, the purpose is not to achieve consensus (of any type, but especially Types 1 and 2). Consensus may occur, but it is important psychologically for the participants not to feel that the process is failing if everyone does not agree.

6.1A.5 Stages of Elicitation

It is useful to consider the overall elicitation process as conceptually divided into two stages. According to this conceptual model, the expert panel is an informed, independently-thinking sample of N evaluators who represent a much larger community of similarly informed evaluators (more precisely, representing the community's position if all in the community were equally informed, where "informed" includes a full understanding of all relevant site-specific

details). The TFI's task is to collect information from the size N sample in order to estimate the state of knowledge of the larger population.

6.1A.5.1 Stage I: Panelists as Independent, Informed Evaluators, Representing Themselves

The desired results from a given elicitation are often the parameters of a model. The experts are asked to provide two types of assessments.

- Each expert provides his or her best estimate (e.g., mean value). This is based on an evaluation of the full range of models, evidence, data, and proponent positions in the community. The assessments are performed in the context of thorough facilitated interaction, including sharing of all relevant local or site-specific information.
- Each expert assesses his or her epistemic uncertainty about the mean estimate. This is also based on thorough interaction. In particular, each expert is exposed to the full range of other panel-member estimates, which should often lead to appropriately wide distributions if there is substantial disagreement. If the TFI's goal were only to represent the panel's composite knowledge, the elicitation would stop here (after sufficient interaction, iteration, etc.). In fact, it is often useful at this stage to construct an initial composite representation of the panel, but this is an intermediate product. A second stage builds additional information useful for extrapolating from the panel to the overall scientific community.

6.1A.5.2 Stage II: Panelists as Integrators, Representing the Overall Expert Community

In this stage, the panelists act as integrators, providing two types of assessments, based in large measure on what they learned from first-stage interactions with the other panel members.

- (a) Each expert provides an estimate of what the composite mean of the entire informed community would be; that is, assuming that an extensive elicitation were performed in which the community were provided the same information base and opportunity for interaction as the panel itself.
- (b) Each expert assesses an estimate of what the composite uncertainty in the community would be if an extensive elicitation were performed.

The Stage II assessments provide the TFI with information a) about each expert's judgment about how well his or her individual interpretation represents the overall community (it is entirely reasonable for an expert to say, "I recognize and can defend that my estimate is lower than the community average"), and b) about whether the panel believes its composite judgment is biased relative to the overall community.

The Stage II elicitation, since it is based largely on information generated in Stage I, typically requires substantially less resources and time than the Stage I elicitation.

6.1A.6 Steps of the Elicitation Process

The elicitation methodology described in NUREG/CR-6372 involves a seven-step process.

6.1A.6.1 Step 1: Identification and Selection of the Technical Issues

For these purposes, a technical question is one that must be answered by the formal elicitation of expert judgments. To justify the required resources, such questions must have potentially significant impacts on the risk assessment results. Depending on the scope of the analysis, the TFI must develop criteria for selection of the questions. For example, some questions may be resolved by simply proposing an answer and soliciting comments from peers. The TFI should seek outside advice (e.g., from the study's sponsors and selected experts) when the questions are selected.

6.1A.6.2 Step 2: Identification and Selection of the Experts

Attempting to define precisely who is an expert is not fruitful. In general, a candidate panelist must have a good professional reputation among his or her peers. In some studies, a formal nomination process has been adopted, in which a long list of potential candidates is developed by consulting the archival literature and by asking technical societies, government organizations, and knowledgeable experts to submit names of researchers and practitioners. Examples of criteria that have been used to select expert panelists include:

- Strong relevant expertise, as demonstrated by professional reputation, academic training, relevant experience, and peer-reviewed publications and reports
- Willingness to forsake the role of proponent of any model, hypothesis, or theory, and perform as an impartial expert who considers all hypotheses and theories and evaluates their relative credibility as determined by the data
- Availability and willingness to commit the time required to perform the evaluations needed to complete the study
- Specific knowledge of the site-specific design, configuration, and technical constraints
- Willingness to participate in a series of open workshops, diligently prepare required evaluations and interpretations, and openly explain and defend technical positions in interactions with other experts participating in the project
- Personal attributes that include strong communication skills, interpersonal skills, flexibility and impartiality, and the ability to simplify and explain the basis for interpretations and technical positions

It is important to ensure that the final group represents a broad spectrum of scientific expertise, technical points of view, and organizational representation. There are additional considerations as well. For example, evaluation ability and experience is especially important for the experts as informed evaluators. The selection process may also be influenced by the way the elicitation of the judgments will be handled. If the TFI plans to interact with the experts individually, it is important to select experts who are (or are willing to become) somewhat familiar with the "big picture" (i.e., what the elicitation process is all about and how their input will be utilized). If, on

the other hand, the TFI plans to form several focused teams of experts and interact with each team as a sub-group, then the primary concern is to ensure that each team includes all the necessary disciplines for their respective issues. The need for each expert to have a broader perspective is not as pressing in the team case.

The advantage of forming teams is that, in highly multidisciplinary problems, each team can be tailored to have the necessary expertise to handle the problem. A drawback may be the presence of a strong personality who forces his or her judgment on the team. However, an effective TFI will recognize this situation and intervene to prevent it from happening. Furthermore, the presence of several teams provides additional assurance that a representative spectrum of scientific judgments will be obtained (i.e., assurance that the teams themselves can act as evaluators and integrators). In large multidisciplinary studies, individual experts could have access to a supporting staff. Of course, the more elaborate the structure of the expert panels, the more costly the process. In the end, the TFI will bear responsibility for both the selection process and the expert-panel structure.

6.1A.6.3 Step 3: Discussion and Refinement of the Technical Issues

The TFI will hold a first meeting with the experts to discuss the technical questions that have been selected in Step 1 and to make sure that everyone understands them as intended (more meetings may be held, if necessary). The TFI needs to make sure that all experts have access to major sources of relevant data. An interaction of this kind is very important, because experience has demonstrated that a major contributor to apparent disagreements is misinterpretation of the problem and its boundary conditions.

Through these interactions, the experts have an opportunity to provide input to the formulation of the technical questions and the precise formulation of the elicitation questions that will be asked. This formulation often involves the decomposition of a complex issue into other issues that are judged to be easier to analyze.

The TFI's role in this step is primarily one of a technical facilitator. The TFI takes a proactive role by collecting and disseminating relevant information and by raising questions and encouraging all experts to participate in the process. This meeting also offers a good opportunity for the TFI to discuss with the experts the concepts of aleatory and epistemic uncertainty (see Section 6.1A.7). Such conceptual subtleties must be discussed so that the experts will have a clear understanding of the issues with which they are dealing.

After the first meeting, the experts should be given time to reflect on the issues and on the discussions that have taken place. They should then provide feedback to the TFI.

Besides the obvious benefits of eliminating misunderstandings, this step also influences the degree to which strong disagreements will surface during the processing of the judgments. For example, an informed group of experts that has debated the issues prior to the actual elicitation is often more likely to cooperate with the TFI in the formulation of the final composite judgment.

6.1A.6.4 Step 4: Training for Elicitation

This step of the process is carried out by the elicitation experts of the TFI team. The basic premise is that domain or substantive experts (i.e., experts on the relevant physical sciences) are not necessarily experienced at producing probability distributions that reflect their true state

of knowledge. The language of probability may be foreign to them, or they may be susceptible to various biases. Moreover, they should be familiarized with problem-structuring tools, such as influence diagrams and logic trees.

The reluctance of some experts to speak in probabilistic terms may be overcome by explaining what probabilities are designed to do and by discussing some simple rules and exercises. The distinction between aleatory and epistemic uncertainty should be further explained in terms of concrete examples.

Possible biases may be characterized as being motivational or cognitive. Of course, the possibility of an expert having a motivation to distort his or her judgments deliberately should have been a factor in the selection of the experts. This does not necessarily mean that the TFI team should ignore candidates with motivational biases, just that those experts should properly fulfill the role of proponents, not evaluators. In fact, the arguments that such proponents advance may be very useful to the panel's deliberations, even though the expert is known to be biased. The facilitation process is explicitly designed to expose and eliminate bias among panel members insofar as possible.

Cognitive biases, such as overconfidence and location bias (i.e., the reporting of narrower-than-justified probability distributions and the systematic overestimation or underestimation of scalar quantities) have been discussed extensively in the literature. The TFI should explain to the experts the existence and nature of these biases in the hope that their impact will be minimized.

6.1A.6.5 Step 5: Group Interaction and Individual Elicitation

An important aspect of the TFI process is the elicitation of probability judgments from individual experts. However, the individual elicitation should be preceded and followed by an important set of group interactions.

A critical element of the individual elicitation is to obtain an accurate probability statement from each expert on all uncertainties of interest. Such a statement is useful, not only for characterizing each expert's position in a form that is usable in the risk assessment models, but also for ensuring full and unambiguous communication among the expert panel.

The actual elicitation process should be conducted with in-depth, face-to-face individual interviews, possibly supplemented by (but not replaced by) the use of preliminary questionnaires. When expert teams are employed, it is important to elicit the team as a group, possibly supplemented by preliminary individual interviews. The structure of the questions to be asked depends on the subject and will be developed by the TFI by taking into account the relevant literature.

The decision analysis literature advises that the experts should be asked to express opinions only on observable (at least, in principle) quantities. In particular, this advice says that questions on event rates and moments of distributions should be avoided, because they are not "observable". Asking the experts questions on "observable" quantities is based on the assumption that this would help them work with quantities that are easier to visualize and understand. However, experience has shown that the experts may be very familiar with selected parametric values, so that related questions are meaningful to them and need not be restricted to only "observable" quantities.

An important element of the process, regardless of whether or not expert teams are formed, is the extensive use of consistency checks and providing feedback to the experts regarding the possible implications of their judgments. The idea is to challenge the experts and to invite self-scrutiny as much as possible. This is a key function of the TFI both as an informational resource to the expert group and as a facilitator of the group interactions.

Before and after the individual elicitation, a number of group interactions need to take place. Examples include:

Information Meetings

There need to be informational meetings of at least three types (although not necessarily separated in time):

(1) Background on objectives of the study and overview of the elicitation process

The experts need to understand the process and their different roles in it. The experts must also understand clearly the distinction between the Stage I elicitation objectives and the Stage II elicitation objectives. In particular, assessing the possible scientific positions of the overall expert community will require a new way of thinking for most experts, so special care must be taken to ensure that the questions are well-defined, meaningful, and thoroughly explained.

(2) Background on the specific problem

Depending on the scope of the study, the panel needs to be briefed by site or regional specialists who provide local or problem-specific knowledge that the panel members will not generally have. Also useful are presentations by local proponents and, possibly, site visits to give the panel firsthand familiarity with the study area. The experts should be encouraged to interact and exchange ideas and interpretations with the specialists.

(3) Background on risk assessment

To be maximally effective, the experts must understand how their judgments will be used. They should be provided with a review of basic risk assessment methodology, the role of probabilistic judgments, and the importance of sensitivity analysis.

Issue Interaction and Data Needs Review

The experts should work together to define and discuss the important issues for which uncertainty needs to be quantified (i.e., those variables that will require individual elicitation). The TFI structures interaction among panel members, specialists, and proponents; facilitates debate; and keeps the group focused on the sensitive parameters and issues.

It is also important to provide the experts with a detailed review of existing data and literature. The experts should be permitted to request additional data summaries and additional reports and papers.

Post-Elicitation Feedback and Interaction

The TFI should summarize the results of the individual elicitations and provide this information as feedback to the entire panel. Panelists should be encouraged to amend their estimates, if they wish, after observing the other experts' judgments. Finally, it is often quite beneficial to conduct a post-elicitation group interaction to enable the experts to ask questions or address important differences or new issues that arise out of the individual elicitations. It is also useful to structure group interaction to exchange viewpoints in preparation for individual expert-as-integrator assessments of the community distribution (Stage II), which must logically follow after the Stage I expert-as-evaluator assessments.

6.1A.6.6 Step 6: Analysis, Aggregation, and Resolution of Disagreements

The TFI has two fundamental roles: that of a Facilitator whose job it is to ensure that the knowledge, data, and models of the expert community are fully and accurately elicited, and that of an Integrator whose job it is to ensure that the diverse information is integrated into a form that is a consistent and accurate representation of the state of knowledge of the expert community.

Because aggregation, if necessary, must follow the analysis of disagreements, it is natural to divide Step 6 into two successive steps: Step 6a, "The Role of TFI as a Facilitator", and Step 6b, "The Role of TFI as an Integrator".

Step 6a. The Role of TFI as a Facilitator

The TFI facilitation process is designed to encourage both the TFI and the experts to understand explicitly the data bases and reasoning upon which different model estimates and expert interpretations are predicated. Moreover, it also demands explicit understanding concerning the rationale underlying each expert's uncertainty assessments.

Successful integration is best achieved through proper facilitation of intensive interaction. Hence, the facilitation role of the TFI is paramount.

Step 6b. The Role of TFI as an Integrator

There are no cookbook formulas for integration, but there are many useful concepts and models that can be used by the TFI. Even in the facilitation role, it is critical for the TFI to be aware of certain key expert aggregation issues, such as:

- Different Degrees of Expertise
- Outliers
- Non-Independent Experts
- Equal Weights
- Non-Equal Weights
- Level of Aggregation

The TFI must be familiar with these issues and models and review them at each stage of the process. There are three basic reasons for this.

- (1) The TFI must have a basic understanding of expert-aggregation issues in order to steer the expert interaction process to result in the simplest possible (e.g., equal weights) integration procedure. Moreover, the issues provide a checklist for the TFI to use in determining when it is appropriate to halt the process.
- (2) If it is determined that non-equal weights or "weighing" of the experts-as-integrators composite representations is the appropriate integration procedure, the aggregation issues and models provide useful information for how to do the non-equal weighting or weighing.
- (3) For experts acting as individual evaluators who must weight scientific models and interpretations, the aggregation issues and associated aggregation models can be directly useful. Since the experts are unlikely to be familiar with aggregation concepts, the TFI will need to use the aggregation issues and models to guide the experts in defining and assessing the weights.

It is important to note that the TFI is not required to use any prescribed, rigid combination formula, such as a fixed weighting scheme. Nevertheless, mathematical expert aggregation models have an important supporting role in the TFI process. The TFI uses these models to check the implications of various assumptions, so that the ultimate aggregation (even if purely behavioral) will be sound and defensible. For example, the TFI may choose to process some disputed evidence using a number of aggregation models to display the numerical impact of specific assumptions. Bayesian methods may also be used to evaluate a number of assumptions regarding the degree of dependence among the experts, as well as the amount of their systematic biases.

6.1A.6.7 Step 7: Documentation and Communication

The primary incentive for the formal elicitation of expert judgments is to supply credibility to the study. It is evident, therefore, that an essential element in accomplishing this is to carefully and thoroughly document every step of the process, as well as the results. It is important that each expert panel member document not only his or her own scientific position, but also his or her estimate of the community position. These detailed records will also prove invaluable when the TFI presents and defends the study to third parties, including peer reviewers and regulatory agencies.

6.1A.7 Overview of Uncertainties

The expert elicitation process must account for two conceptually different contributions to uncertainty.

- **Aleatory Uncertainty:** Aleatory uncertainties are "random" in character. They are uncertainties that for all practical purposes cannot be known in detail or cannot be reduced (although they are susceptible to analysis concerning their origin, their magnitude, and their contribution to risk).
- **Epistemic Uncertainty:** Epistemic uncertainties are "lack-of-knowledge" uncertainties. They arise because our scientific understanding is imperfect for *the present*, but are of a character that in principle are reducible through further research and gathering of more and better experience and data.

To better understand the subtle distinctions between these sources of uncertainty, it is useful to consider the nature of physical models ("models of the world") – recognizing that they can be either deterministic or probabilistic, depending on the application – and our knowledge and ability to model the phenomena of interest (the "world"). We then acknowledge that the models themselves, as well as the parameters appearing in them, may be uncertain and we introduce probabilities to express these uncertainties. The uncertainties that are part of the model of the world, if any, are called aleatory uncertainties (other names in the literature are "stochastic" or "random" uncertainties). Even under "perfect information" (i.e., when the model has been validated and the numerical values of its parameters are known), these aleatory uncertainties are still present.

The uncertainties that stem from our lack of knowledge concerning the validity of the models and the numerical values of their parameters are referred to as epistemic uncertainties. As information is collected, the epistemic uncertainties are reduced.

Thus, aleatory uncertainties affect our ability to precisely predict the outcome from a model, due to "random variations" of the known model parameters. We cannot reduce this source of uncertainty, unless we can somehow alter the variability of these parameters. Epistemic uncertainties affect our ability to predict how well the model represents the "real world". In principle, we can reduce the epistemic uncertainties to zero, if we perfectly calibrate our models and confirm that they perfectly reproduce the observed "real world" behavior.

During the elicitation process, the experts must account for both sources of uncertainty when they present their results. In effect, for each "model of the world" that they evaluate, they must answer the following questions.

- What is the range of possible results from this model, due to "random variations" in the input parameters (and other parameters that may affect the computation)?
- What is our confidence that this particular model accurately represents how the "real world" works?

These requirements do not imply that every expert elicitation must undertake a highly refined uncertainty analysis in order to be valid. Depending on the application, the uncertainty treatment may be adequate while relying largely on experience in similar situations and the judgments of the analysts for its support. However, the elicitation methodology emphasizes that unless the analysis team deals explicitly with the major uncertainties, instead of "ducking" them, the results will not be complete, and the full description of the problem faced will not have been effectively communicated to the users of the results.

6.1A.8 Peer Reviews

The guidance in NUREG/CR-6372 strongly recommends that peer reviews should be conducted for the expert elicitation process. The purpose of the peer reviews is to provide assurance that a proper process has been followed, that the study incorporates the diversity of views prevailing within the technical community, that uncertainties have been properly considered and incorporated into the analysis, and the study documentation is clear and complete.

Classically, peer review is conducted by 1) one or more technical peers of the study participants who are "independent" of the study, and 2) at the end of the project. In recent years, experience on several large projects has shown that active "participation" by peer reviewers throughout the course of the study can provide valuable input to the process being followed and can serve to define mid-course corrections that can improve the quality of the final product. Thus, two different types of peer review are considered.

- **Participatory Peer Review:** This is an ongoing review that provides the peer reviewers with full and frequent access throughout the entire project. The process is structured to seek peer review comments at numerous stages, and includes peer review interaction with both the study team and, if appropriate, with the consultants and/or experts whose input is important to the final product. The principal benefit of a participatory peer review is that, if problems are discovered, the opportunity exists for a mid-course correction without the need for work to be substantially redone at the end. One limitation is that peer reviewers might lose their objectivity as they interact with the project over time.
- **Late-Stage Peer Review:** This is a review that occurs only after the project has been almost completed. Usually, such a review takes place when a draft of the final report has been prepared, or when the project's bottom-line results are close to being in final form. Sometimes, a late-stage peer review can examine an intermediate-stage result when it has been almost completed. The principal limitation of a late-stage peer review is that, if major problems are discovered, the work may need to be substantially redone, without the mid-course-correction benefits of a participatory peer review. The use of a late-stage review is, therefore, a "gamble" – usually an informed gamble, of course – on the part of the sponsors that major problems will not be discovered. A late-stage review has the benefit of a perception of complete independence.

The guidance also distinguishes between two different aspects of the study that should be reviewed.

- **Technical Peer Review:** This is the review of the technical aspects of a study, such as the problem characterization, relevant models, completeness and quality of the data, calculation methods, final results, and sensitivity and uncertainty analyses. Reviewing this aspect requires expertise in the relevant technical disciplines and computational methodologies.
- **Process Peer Review:** This is the review of how the study is structured and executed. The process peer review concentrates on assuring that the elicitation and incorporation of expert judgments and the consideration of uncertainties are done well. Reviewing this aspect requires expertise in expert elicitation, statistical analysis, and related disciplines, as well as adequate familiarity with the technical issues and methods involved in the project.

In general, the guidelines strongly recommend that participatory technical peer reviews and participatory process peer reviews should be conducted for large, complex studies that require extensive input from expert elicitations. Participatory reviews are also recommended for smaller studies with simpler issues, but it is acknowledged that late-stage reviews can be acceptable in these cases.

6.1A.9 References

- 6.1A-1. "Expert Opinion in Risk Analysis: The NUREG-1150 Methodology", Hora, S. C. and R. L. Iman, *Nuclear Science and Engineering*, 102:323-33 1, 1989
- 6.1A-2. "Severe Accident Risks: An Assessment for Five U.S. Nuclear Power Plants - Final Summary Report," NUREG-1150, 3 volumes, U.S. Nuclear Regulatory Commission, Office of Nuclear Regulatory Research, December 1990
- 6.1A-3. "Recommendations for Probabilistic Seismic Hazard Analysis: Guidance on Uncertainty and Use of Experts", NUREG/CR-6372, 2 volumes, Senior Seismic Hazard Analysis Committee (SSHAC), Lawrence Livermore National Laboratory, prepared for U.S. Nuclear Regulatory Commission, Office of Nuclear Regulatory Research, April 1997
- 6.1A-4. "Guidance for Performing Probabilistic Seismic Hazard Analysis for a Nuclear Plant Site: Example Application to the Southeastern United States", NUREG/CR-6607, Lawrence Livermore National Laboratory, prepared for U.S. Nuclear Regulatory Commission, Office of Nuclear Regulatory Research, October 2002
- 6.1A-5. "Branch Technical Position on the Use of Expert Elicitation in the High-Level Radioactive Waste Program", NUREG-1563, U.S. Nuclear Regulatory Commission, Office of Nuclear Material Safety and Safeguards, November 1996
- 6.1A-6. "Expert Elicitation Approach for Performing ATHEANA Quantification", Forester, J., D. Bley, S. Cooper, E. Lois, N. Siu, A. Kolaczowski, and J. Wreathall, *Reliability Engineering and System Safety*, 83 (2004) 207–220, 2004
- 6.1A-7. "ATHEANA User's Guide", NUREG-1880, U.S. Nuclear Regulatory Commission, Office of Nuclear Regulatory Research, June 2007
- 6.1A-8. "Estimating Loss-of-Coolant Accident (LOCA) Frequencies Through the Elicitation Process", NUREG-1829 (Draft), U.S. Nuclear Regulatory Commission, Office of Nuclear Regulatory Research, June 2005

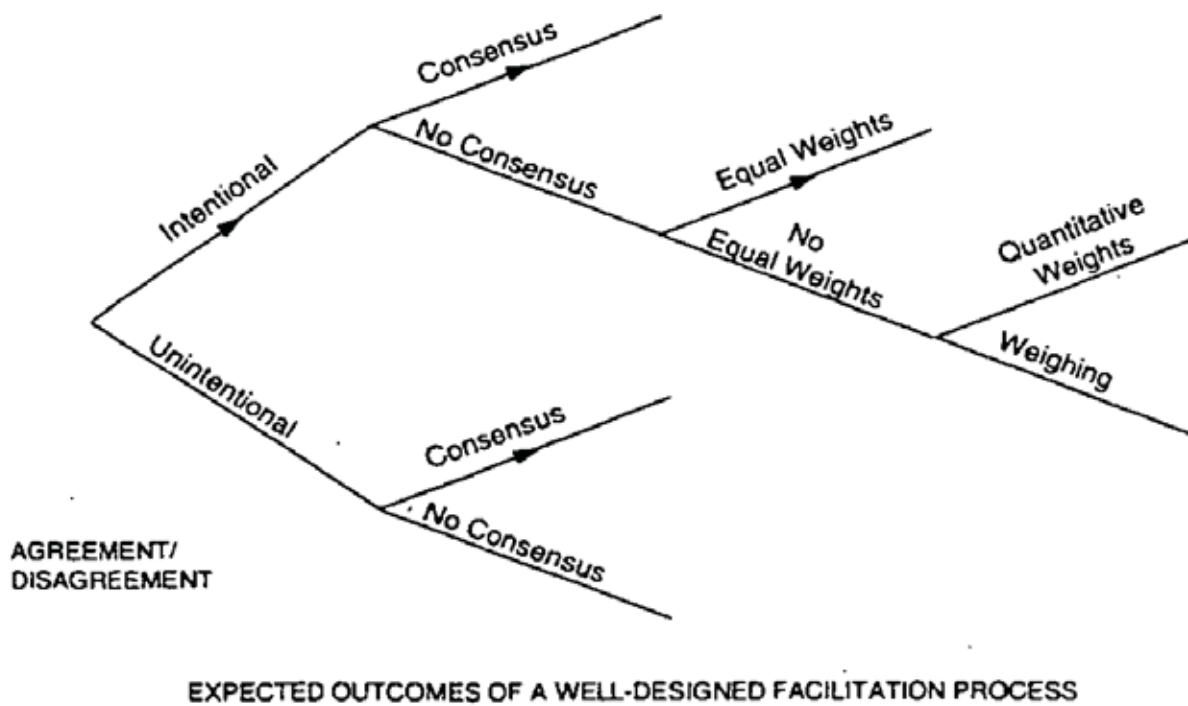

Figure 6.1A-1. Expert Elicitation Logic Process

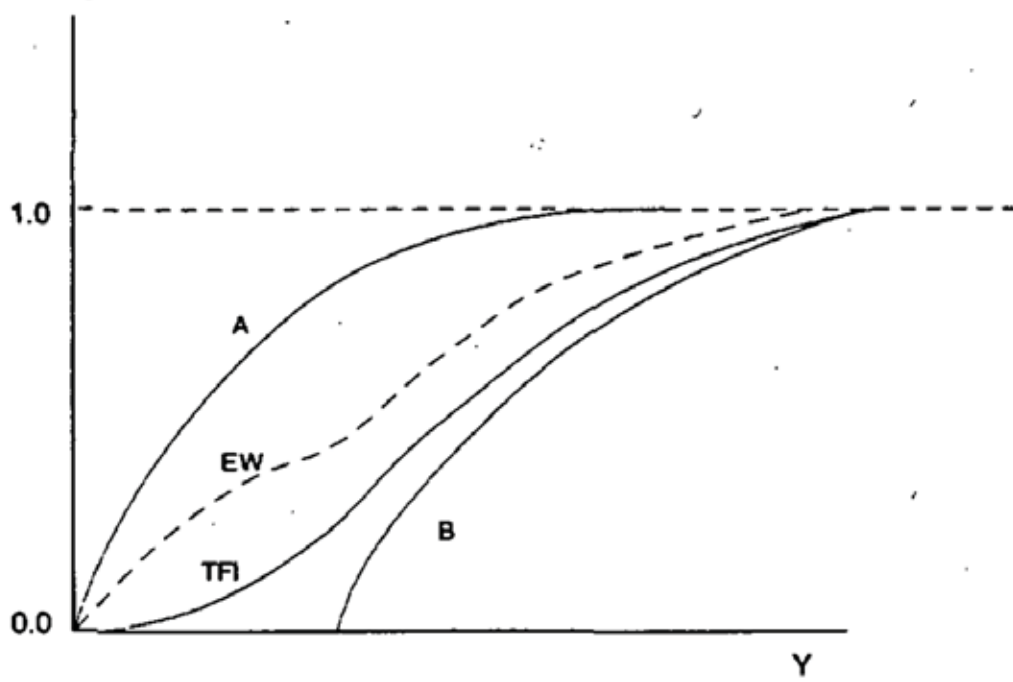

Figure 6.1A-2. Example of Behavioral Aggregation

6.2 SEISMIC-INDUCED SLOPE FAILURE ANALYSES

Analyses were performed to evaluate the stability of the slopes at the North end of the SDA site along Erdman Brook and at the East side of the site along Frank's Creek. The scope of the analyses included potential slope failures that may be caused by seismic events and potential landslides that may occur due to other natural processes. The analyses also evaluated the extent of damage to the SDA trenches if a slope failure occurs, including the associated uncertainties. This section describes the analyses that were performed to evaluate the likelihood of potential slope failures that may be caused by seismic events.

6.2.1 Analysis Methodology and Models

Consideration of potential failure scenarios for the SDA involved evaluation of the stability of the steep-sided erosional valleys that bound the SDA site on the North and East. The computer program WinSTABL, Version 2.40, (Reference 6.2-1) was used for the slope stability evaluation. The following brief model description is adapted from information provided by the program authors.

WinSTABL is a graphical user interface for the STABL slope stability program. STABL is a public-domain computer program developed by Purdue University for the general solution of slope-stability problems by a two-dimensional limiting equilibrium method. The calculation of the factors of safety against slope instability is performed by a method of slices. STABL uses random techniques for generating potential failure surfaces for subsequent determination of the more critical surfaces and their corresponding factors of safety. The two fundamental portions of the stability analysis are slope geometry and slope material (usually soil) characteristics (such as weight, cohesive strength, and friction angle). The program considers heterogeneous soil systems, anisotropic soil strength properties, excess pore water pressure, static groundwater and surface water levels, and pseudo-static earthquake loading.

The particular method employed for the SDA slope analyses is an adaptation of the Simplified Bishop Method. The Simplified Bishop Method is based on the assumption that the inter-slice forces are horizontal. A circular slip surface is assumed, and forces are summed in the vertical direction. The resulting equilibrium equation is combined with the Mohr-Coulomb equation to determine the forces on the base of the slice. Moments are summed about the center of the circular slip surface to obtain the following expression for the factor of safety (F).

$$F = \frac{\sum \left[\frac{c' \Delta x + (W + P \cos \beta - u \Delta x \sec \alpha) \tan \phi'}{m_\alpha} \right]}{\sum W \sin \alpha - \frac{\sum M_p}{R}}$$

In this formulation, Δx is the width of the slice, assuming that all slices have the same width, and m_α is defined by the following equation.

$$m_\alpha = \cos \alpha + \frac{\sin \alpha \tan \phi'}{F}$$

where

F	=	Factor of safety
c'	=	Effective cohesion
W	=	Weight of each slice
P	=	Resultant water force acting perpendicular to the top of the slice
β	=	Inclination of the top of the slice
u	=	Water pressure at the base of each slice
α	=	Inclination of the bottom of the slice
ϕ'	=	Effective internal angle of friction
M_p	=	Moment about the center of the circle produced by the water force acting on the top of the slice
R	=	Radius of the circle

The equation satisfies equilibrium of forces in the vertical direction and overall equilibrium of moments about the center of a circle. Because the value of the term m_α depends on the factor of safety (F), F appears on both sides of the equation. The equation cannot be manipulated to obtain an explicit expression for F. Thus, an iterative procedure is required to solve for F.

6.2.1.1 Slope Stability Models

For the SDA analyses, two-dimensional slope geometry was determined using topographic maps of the valleys on the North and East sides of the site (Reference 6.2-2). In addition, the initial estimates of the soil physical properties were obtained from Reference 6.2-2, wherein the authors indicate that the soil strengths used in their stability analyses were "based on previous laboratory testing of similar soils obtained from other areas of the WVDP" and were values that "are conservative engineering soil property values of the slope subsoils".

Three slope cross-sections were evaluated. One was representative of the north-facing slope between the northern limits of Trenches 2, 3, 4, and 5 and Erdman Brook. The second was representative of the east-facing slope between Trenches 1 and 2 and Frank's Creek. The third was representative of the east-facing slope between Trench 8 and Frank's Creek.

Slope surface topography and subsurface points representing soil type changes or groundwater surfaces were entered into the slope stability analysis program as cross-section coordinates. Each cross-section was drawn to scale, with vertical dimensions tied to the ground-surface elevation and horizontal dimensions sufficient to include the lowest elevation point in the valley (typically the position of the brook or creek) and a high elevation point approximately 500 feet away from that low point. Each high elevation point was a point on top of the SDA trench cover.

The WinSTABL program systematically considers possible failure planes satisfying specified geometric limitations. Specified limitations include the points on each end of a potential circular slip surface where that surface intersects the ground surface. For the SDA analyses, the low point, or origination, of the slip surface was associated with the low points of the cross-section (i.e., the creek position and base of the steep section of the valley slope). The high point, or termination, of the slip surface ranged from the top of steep valley slope (usually a few 10's of feet to 100 feet from the origination point) and the limit of the cross-section (typically 400 to 500 feet from the origination point). With these geometric limitations, each WinSTABL analysis run considered 200 potential slip surfaces ranging from shallow-seated surfaces that extended only into the uppermost soil layers (and not into trench waste) to deep-seated surfaces that

extended relatively deeply into the tills and penetrated trench waste. The outcome of each analysis run was the identification of 10 potential slip surfaces exhibiting the lowest factors of safety against slope failure.

6.2.1.2 Characterization of the SDA Site

Each point comprising the slope stability cross-sections was associated with a soil layer characterized by specific physical properties. A range of soil properties, including unit weight, cohesive strength, and internal friction angle, was associated with each soil type. Also, a range of groundwater levels was associated with each cross-section and the soil types present in the cross-section. Probability distributions were applied to quantify the uncertainties about these site conditions during the 30-year period of this study.

Soil Properties

The layered soil materials considered in the SDA slope stability evaluations and the ranges of physical properties considered are summarized in Table 6.2-1. The weathered till and unweathered till materials are natural materials. Cover soil is the compacted soil cap constructed over the SDA trenches, and waste represents the mixture of disposed waste and soil filling the SDA trenches. The properties considered applicable to these materials were based on the values reported in Reference 6.2-2. These values were then varied upward or downward on the basis of properties ranges typical of similar materials, as identified in various geotechnical engineering references, or based on the professional judgment of those involved in performing the slope stability analyses.

The following probabilities were assigned that each soil strength condition represents actual site conditions throughout the 30-year period of this study.

- High Strength: Probability = 10%
- Nominal Strength: Probability = 65%
- Low Strength: Probability = 25%

Four material types are considered in the slope stability analyses. Three are natural soil materials (undisturbed tills and the landfill cover soil that is assumed to have been constructed using excavated till) and the fourth is trench-fill material that is assumed to be approximately 50% disposed waste and 50% soil fill. The properties of the natural materials are assumed to range above and below the properties of undisturbed natural materials reported in Reference 6.2-2. Similarly, the properties of disposed waste materials are assumed to range above and below those of wastes disposed at a typical hazardous waste landfill. Similarity is assumed between the radioactive wastes disposed at the SDA and hazardous wastes because of the predominance of non-degradable materials in both waste types.

Nominal-Strength Conditions

Conditions similar to those that have been measured for site tills are assumed to have a 65% likelihood of accurately representing site conditions. A high likelihood of occurrence is assigned because the properties considered for this condition are similar to those reported for undisturbed site soil. Specific values for soil weight, porosity, moisture content, cohesion, and friction angle that are slightly higher (for unweathered till) or slight lower (for weathered till and

soil cover) than the reported values were assigned to the three natural material types. Similarly, nominal waste properties are based on values reported for waste landfilled at the SDA (Reference 6.2-3) and as documented for hazardous wastes disposed at other locations.

High-Strength Conditions

This condition is assumed to be much less likely than the nominal-strength condition. Strengths assigned to natural materials and disposed waste for this condition are assumed to have a 10% likelihood of accurately representing site conditions. For this condition, values higher than nominal are assumed for soil strength parameters (cohesion and friction angle) and values lower than nominal are assumed for moist and saturated soil weights. Higher soil strength and lower soil weight combine to produce slopes that are more stable than the nominal strength condition.

Low-Strength Conditions

This condition is assumed to be less likely than the nominal-strength condition, but more likely than the high-strength condition. Strengths assigned to natural materials and disposed waste for this condition are assumed to have a 25% likelihood of accurately representing site conditions. For this condition, values lower than nominal are assumed for soil strength parameters (cohesion and friction angle) and values higher than nominal are assumed for moist and saturated soil weights. Lower soil strength and higher soil weight combine to produce slopes that are less stable than the nominal strength condition.

Groundwater Levels

Groundwater levels considered in the WinSTABL slope analyses included levels associated with three fluid levels in the SDA trenches.

Level Descriptor	Trench fluid level	Groundwater level
High	Maximum level, fluid at the top of the excavated SDA trench.	Groundwater levels within the weathered and unweathered tills between the SDA trenches and slope analysis cross-section low point (i.e., the active channel of either Erdman Brook or Frank’s Creek) are interpolated between the fluid level in the SDA trench and the estimated surface-water elevation in the creek. Groundwater levels in NYSERDA monitoring wells were considered. Interpolated groundwater levels thus considered vary (high-middle-low) and result in differing degrees of soil material saturation for the slope analyses.
Middle	Fluid levels approximately at 2008 levels, as measured in March by NYSERDA. 2008 levels in all trenches are a few feet to several feet below the contact between weathered and unweathered till.	
Low	Minimum level, fluid at the bottom of the excavated SDA trench.	

The following probabilities were assigned that each level condition applies throughout the 30-year period of this study.

- High Level: Probability = 0.12%
- Middle Level: Probability = 94.88%
- Low Level: Probability = 5.00%

The probabilities for these groundwater levels were derived from the analyses that are summarized in Section 6.7. In the slope stability analyses, the Level 1 probability was used for the groundwater High Level condition. The probabilities for Level 2 and Level 3 were combined for the Middle Level condition. The probability for Level 4 was used for the Low Level condition.

Composite Probabilities for SDA Site Conditions

Table 6.2-2 summarizes the composite probabilities for each of the nine possible combinations of soil strength and groundwater level that may apply at the site. For example, the condition of Low Soil Strength is assigned a probability of 25%, and the condition of Low Groundwater Level is assigned a probability of 5%. The composite probability for the "Low – Low" input condition is $(0.25) * (0.05) = 0.0125$. Thus, there is a probability of 1.25% that the "Low – Low" conditions will actually apply at the SDA during the 30-year study period. This probabilistic weight is then assigned to all WinSTABL analyses that use these "Low – Low" input parameters.

6.2.2 Seismic-Induced Slope Failures

The analysis methodology and parametric information summarized in Section 6.2.1 were used to evaluate stabilities of the slopes at the North end and East side of the SDA for a range of seismic loads. The analysis results were also used to evaluate the extent of intrusion into the waste trenches if a slope failure occurs, and the corresponding uncertainties about the trench breach depths.

In this summary, waste Trenches 1 and 2 are designated as "Trenches 1/2" to emphasize the fact that they abut each other longitudinally. Trench 1 occupies approximately 350 feet at the southern end, and Trench 2 occupies approximately 350 feet at the northern end of this trench row.

6.2.2.1 Scope of Analyses

Analyses were performed for the following slopes adjacent to the SDA.

- North slope between Erdman Brook and the North ends of Trenches 1/2, 3, 4, and 5
- North end of the East slope between Frank's Creek and Trenches 1/2
- South end of the East slope between Frank's Creek and Trench 8

The North slope analyses were performed using the specific configuration of Trench 4. If the slope failed, it was assumed that similar breach depths also apply to the north ends of Trenches 1/2, 3, and 5.

The East slope was subdivided to examine the potential effects from topographic differences along the north and south portions of that slope.

Seismic loads were input as horizontal peak ground acceleration without regard to direction, spectral content, or earthquake duration. This is consistent with the characterization of the seismic hazard for the site, as summarized in Section 5.5.

Preliminary analyses confirmed that there is a low likelihood of significant slope failures at accelerations below 0.25 g. Therefore, analyses were performed for five discrete accelerations of 0.25 g, 0.35 g, 0.50 g, 0.70 g, and 1.0 g. Accelerations above 1.0 g were not analyzed, due to the observation that the extent of damage does not change very significantly over the range from 0.70 g to 1.0 g, and in consideration of the low annual frequency of very severe earthquakes. Thus, it was concluded that accelerations higher than 1.0 g would produce similar damage, but at a much lower annual frequency, and their explicit analyses are not necessary.

Each slope was analyzed for the nine probabilistically weighted combinations of potential soil strength and groundwater level that are summarized in Table 6.2-2.

Thus, the scope of the analyses required 135 runs of the WinSTABL code (3 slopes x 9 parameter sets per slope x 5 seismic accelerations).

6.2.2.2 Interpretation of Results

Inputs to the WinSTABL code specify the range of possible slope stability computation surfaces to be examined. For these analyses, the initiating points were specified at the toe of the slope, and the maximum extent of the potential failures was specified at 500 feet from zero point. Sensitivity calculations were performed to confirm that the geometries of the code-generated computation surfaces are not sensitive to these parameters within the applied range. In particular, the maximum extent of the potential failure surfaces remains well below the input limit of 500 feet, and it is not altered significantly if this limit is extended further. Thus, the possible failure surface configurations are determined primarily by the slope geometry, soil strength, and groundwater conditions, and they are not otherwise significantly constrained.

For each run, the code generated 200 possible slope stability computation surfaces. Each surface represents the final geometry of the slope, if failure occurs along that surface. Based on the available documentation and the QRA team's understanding of the code, it is reasonable to assume that each computation surface is an equally likely representation of the final slope geometry. Thus, if failures are guaranteed to occur along all 200 surfaces, it is reasonable to assign 0.5% probability (i.e., 1 / 200) that any particular surface represents the actual post-failure configuration of the slope. This is a fundamental assumption for the following interpretations of the analysis results.

The WinSTABL code is typically used to identify the ten most vulnerable surfaces and to evaluate whether they will fail under the specified seismic loading. Factor of Safety (FS) values are computed for each of the ten most limiting critical surfaces. The critical surface configurations and their corresponding FS values form the primary output of the code. According to this computation process, it is known that the other 190 possible surfaces have FS values that are higher than the upper end of the ten most limiting surfaces. However, without substantial modifications to the code, it is not possible to determine those FS values, or to know how they apply to any specific surface within the remaining 190. The code provides plots of the final configurations for all 200 computation surfaces.

The following process and assumptions were used to apply the WinSTABL results for this study.

- It was assumed that the slope will fail along a particular surface if the FS value for that surface is less than 1.0. It was assumed that no failure will occur if the FS value is greater than, or equal to, 1.0.
- If the FS values for all ten critical surfaces are ≥ 1.0 , no slope failures occur for the specified conditions.
- If the maximum FS value for the ten critical surfaces is ≥ 1.0 , failures will not occur along any of the other 190 surfaces. All of those surfaces have FS ≥ 1.0 . The only failures are those depicted in the primary output from the code.
- If the FS values for all ten critical surfaces are < 1.0 , it was assumed that all 200 surfaces can fail. In other words, it was assumed that all 200 surfaces have FS < 1.0 .

The last assumption introduces an unknown amount of conservatism into the results for this study. For example, if the maximum FS value for the ten critical surfaces is 0.99, it is very likely that most, if not all, of the remaining 190 surfaces have FS ≥ 1.0 . However, if the maximum FS value for the ten critical surfaces is 0.40, it is very likely that a large number of the remaining 190 surfaces have FS < 1.0 . No attempt was made to assign probabilities for these relative likelihoods. In all cases, it was simply assumed that all remaining 190 surfaces have FS < 1.0 . This assumption provides an upper bound for the extent of damage that may result from each evaluated input condition.

For each condition that results in one or more surfaces with FS < 1.0 , plots of the failure surface geometries were examined to determine which surfaces, if any, intersect the waste trenches and the extent of each trench breach. Figure 6.2-1 shows a plot of the ten critical computation surfaces for one of the North slope analyses. This particular analysis shows that all ten of the critical surfaces have FS < 1.0 . Thus, all ten surfaces will fail for the applied input conditions. The trench is depicted by the generally rectangular cross-section below the compacted soil cap, with its left (north) end beginning above approximately 200 feet on the scale at the bottom of the plot. The plot shows that nine of the ten critical surfaces intersect the trench. One failure surface removes a portion of the slope between the toe and approximately midway to the trench. This surface does not breach the trench, and it was excluded from the results for this study. Each of the nine surfaces that intersects the trench was assigned an equal 0.5% weight that the final slope geometry would be as depicted by the surface. The depth of each trench breach was estimated by the point at which the right edge of the failure surface intersects the top of the trench. This estimation process also introduces some conservatism, especially for relatively shallow surfaces. For example, considering the right-most surface in Figure 6.2-1, the breach distance varies from approximately 95 feet at the trench bottom to approximately 145 feet at the trench top. The 145-foot value was used to characterize this surface, because the failure will disrupt trench materials throughout this range. Since the trench inventories are known only within 50-foot increments, the breach depths were compiled into 25-foot intervals. Thus, the plot in Figure 6.2-1 provides the following information for this case.

High Soil Strength, High Groundwater Level Seismic Acceleration = 1.0 g Only Critical Failure Surfaces		
Trench Breach Depth (feet)	Number of Surfaces	Fraction of 200 Surfaces
0 – 25	1	0.005
26 – 50	1	0.005
51 – 75	1	0.005
76 – 100	2	0.010
101 – 125	3	0.015
126 – 150	1	0.005

In this particular case, all ten of the critical surfaces have $FS < 1.0$. Therefore, it was assumed that all of the remaining 190 surfaces would also fail. Figure 6.2-2 shows the plot of those surfaces. A similar process was used to count the number of these surfaces that intersect the trench at each breach depth and add them to the results from the ten critical surfaces. The following table summarizes the combined results from this case.

High Soil Strength, High Groundwater Level Seismic Acceleration = 1.0 g All Failure Surfaces		
Trench Breach Depth (feet)	Number of Surfaces	Fraction of 200 Surfaces
0 – 25	9	0.045
26 – 50	3	0.015
51 – 75	1	0.005
76 – 100	4	0.020
101 – 125	6	0.030
126 – 150	2	0.010

Table 6.2-2 shows that there is a probability of 0.01% that the "High – High" conditions will actually apply at the SDA during the 30-year study period. Thus, if a 1.0 g earthquake occurs under these conditions, the following table summarizes the fraction of all possible slope failure surfaces that breach the trenches to each depth.

High Soil Strength, High Groundwater Level SDA Site Condition Probability = 0.0001 Seismic Acceleration = 1.0 g	
Trench Breach Depth (feet)	Slope Failure Fraction
0 – 25	4.50E-02
26 – 50	1.50E-02
51 – 75	5.00E-03
76 – 100	2.00E-02
101 – 125	3.00E-02
126 – 150	1.00E-02

For example, the first entry in these results is interpreted as follows.

- There is 0.01% (i.e., 1/100 of 1%) probability that High Soil Strength and High Groundwater Level conditions apply at the SDA site.
- If a 1.0 g earthquake occurs under these conditions, 4.5% of the possible North slope failure surfaces will breach the North ends of Trenches 1/2, 3, 4, and 5 to a distance between 0 and 25 feet.

The same process was used to evaluate and compile the results from all 135 WinSTABL runs.

6.2.2.3 Slope Fragilities

The results from each analysis were compiled to compute the cumulative fraction of slope failures that exceed each interval of the trench length. Continuing the example from Section 6.2.2.2, that process provides the following results.

High Soil Strength, High Groundwater Level SDA Site Condition Probability = 0.0001 Seismic Acceleration = 1.0 g	
Trench Breach Depth (X, feet)	Cumulative Slope Failure Fraction with Breach Depth \geq X
1	1.25E-01
25	8.00E-02
50	6.50E-02
75	6.00E-02
100	4.00E-02
125	1.00E-02

High Soil Strength, High Groundwater Level SDA Site Condition Probability = 0.0001 Seismic Acceleration = 1.0 g	
Trench Breach Depth (X, feet)	Cumulative Slope Failure Fraction with Breach Depth \geq X
150	0

The complete results are summarized in Table 6.2-3 for the North slope, Table 6.2-4 for the northern end of the East slope, and Table 6.2-5 for the southern end of the East slope. These compilations provide useful engineering insights regarding the contributors to slope failures. For example, the North slope results in Table 6.2-3 show that only Low Soil Strength conditions contribute measurably at accelerations below 0.50 g. The results also show a relatively small influence from groundwater level, compared to soil strength. For example, at an acceleration of 0.25 g, the total fraction of failures that breach the trenches ranges from 7.5% under High Level conditions to 9.0% under Low Level conditions. As expected, the results show increasing contributions from other slope conditions as the seismic acceleration increases.

There is a significant increase in the mean fraction of damaging slope failures as the applied acceleration increases from 0.35 g to 0.50 g. The mean fraction continues to increase as the acceleration increases from 0.50 g to 1.0 g, but at a decreasing rate. This behavior indicates that the extent of damage from the slope failures will not increase significantly at accelerations above 1.0 g.

The composite results in Table 6.2-3 can be plotted in the fragility curve format shown in Figure 6.2-3. These curves plot lines of constant probability from the cumulative results. For example, if a vertical "slice" is made through the curves in Figure 6.2-3 at the 1.0 g acceleration level, the points from each curve would plot the cumulative fraction of failures that exceed each breach depth at that acceleration, in the same manner as tabulated above (but also accounting for the contributions from all nine possible slope conditions). Figure 6.2-4 shows the cumulative probability distribution for this "slice" at 1.0 g.

When reading the curves in Figure 6.2-3, it is helpful to note that the probabilities are accumulated in the downward direction. In other words, the lowest cumulative probability is near the top of the figure, and the highest cumulative probability is near the bottom. This depiction is "upside down" from other types of fragility curves that are often developed for QRA analyses. However, it provides a more meaningful display for these particular analysis results. For example, the distinct changes between 0.35 g and 0.50 g are apparent, as is the relative stability of the results at accelerations above approximately 0.70 g. The large uncertainties in these analyses are also clearly evident.

6.2.2.4 Correlation of North Slope and East Slope Failures

Separate analyses were performed for each of the three major sections of the slopes adjoining the SDA. The results in Table 6.2-4 and Table 6.2-5 show that the likelihood of damaging slope failures at the southern end of the East slope is generally lower than the failure likelihood at the northern end, for the same applied acceleration. Thus, the extent of damage at the eastern edge of the Southern Disposal Area (i.e., affecting Trenches 8 and 9) will be somewhat less than the extent of damage at the eastern edge of the Northern Disposal Area (i.e., affecting

Trenches 1/2 and 3). However, these differences decrease at higher accelerations. The integrated analyses for this study were simplified substantially by conservatively assuming that the entire East slope behaves according to the results shown in Table 6.2-4 for the northern section. In other words, it was assumed that the failure fractions for Trenches 1/2 also apply for Trench 8, and the failure fractions for Trench 3 also apply for Trench 9. If the study results show that the overall site risk is strongly influenced by this simplification, the detailed results in Table 6.2-4 and Table 6.2-5 can be used to further refine the East slope analyses.

Of course, an earthquake does not affect the North slope and the East slope independently. If both slopes have the same soil properties and the same groundwater levels, it is likely that their behavior will be highly correlated. Table 6.2-6 summarizes the extent of combined damage, assuming that the slope failures are fully correlated.

At low accelerations (e.g., 0.25 g – 0.35 g), it is most likely that failures of the North slope will breach only the north ends of Trenches 1/2, 3, 4, and 5, up to a maximum depth of approximately 75 feet. However, if the slope conditions are such that the breach depth from the North slope exceeds 75 feet, then it is likely that failures of the East slope will also breach Trenches 1/2 and 8. At still weaker slope conditions, when the breach depth from the North slope exceeds 125 feet, it is likely that failures of the East slope will also breach Trenches 3 and 9. In fact, based on the nine probabilistically weighted slope conditions, Table 6.2-6 shows that the maximum extent of damage has a somewhat higher likelihood than the intermediate damage. However, it may be important to distinguish among these various levels of damage, because the frequencies and consequences of the respective trench releases have different impacts on the overall site risk.

The amount of correlated damage increases at higher accelerations. For example, at an acceleration of 1.0 g, failures of the North slope may breach only the north ends of Trenches 1/2, 3, 4, and 5, up to a maximum depth of approximately 25 feet. If the slope conditions are such that the breach depth from the North slope exceeds 25 feet, then it is likely that failures of the East slope will also breach Trenches 1/2 and 8. When the breach depth from the North slope exceeds approximately 50 to 75 feet, it is likely that failures of the East slope will also breach Trenches 3 and 9. At these high accelerations, Table 6.2-6 also shows that the minimum damage and the maximum damage have approximately equal likelihoods.

6.2.3 Seismic-Induced Slope Failure Fragilities for SDA Models

Based on the analyses summarized in Section 6.2.2, the SDA risk assessment evaluates two potential impacts from seismic-induced failures of the North and East slopes.

- **Damage Condition 1:** Slope failures intersect Trenches 1/2, Trench 8, and 125 feet of the north ends of Trenches 3, 4, and 5
- **Damage Condition 2:** Slope failures intersect Trenches 1/2, Trench 3, Trench 8, Trench 9, and 250 feet of the north ends of Trenches 4 and 5

These damage conditions were derived from the information in Table 6.2-6. The first breach column in that table accounts for North slope failures that affect only the north ends of Trenches 1/2, 3, 4, and 5. The breaches extend from approximately 25 feet to approximately 75 feet before failures of the East slope affect Trenches 1/2 and 8. The second breach column

in Table 6.2-6 accounts for failures of the East slope that breach Trenches 1/2 and 8, but do not breach Trenches 3 and 9. These failures also involve breaches that affect approximately 75 feet to approximately 125 feet of the north ends of Trenches 3, 4, and 5. The third breach column in Table 6.2-6 accounts for failures of the East slope that breach Trenches 1/2, 3, 8, and 9. These failures also involve approximately 250 feet of the north ends of Trenches 4 and 5.

Damage Condition 2 directly accounts for the impacts from the third breach column in Table 6.2-6. Damage Condition 1 conservatively bounds the impacts from the first two breach columns. In principle, Damage Condition 1 could be subdivided to define an additional condition that accounts only for breaches of the north ends of Trenches 1/2, 3, 4, and 5. However, Table 6.2-6 shows the extent of that damage would involve only about the first 25 feet of the trenches. For seismic accelerations above 0.50 g, the East slope begins to affect Trenches 1/2 and 8 when the North slope breach depth exceeds approximately 25 feet. For accelerations below 0.35 g, damage that affects only the north ends of the trenches extends to approximately 75 feet before the East slope breaches Trenches 1/2 and 8. Preliminary estimates for the amount of radioactive material released from only the north ends of the trenches, compared to combined releases from the second breach column in Table 6.2-6, indicated that the potential risk reduction from separating these releases does not justify the additional effort required for their explicit evaluation. Therefore, Damage Condition 1 provides a conservative bound for the combined impacts from breaches that affect only the north ends of the trenches and breaches that involve Trenches 1/2 and 8. If the study results show that the overall SDA risk is sensitive to this conservative simplification, Damage Condition 1 may be subdivided to further refine its risk contributions.

Table 6.2-7 summarizes the fragility values that are used in the SDA risk assessment for each damage condition. The fragilities for Damage Condition 2 are derived from the failure fractions in Table 6.2-4 for East slope failures that breach Trench 3 (i.e., East slope failures that breach Trenches 1/2, 3, 8, and 9). The fragility values for Damage Condition 1 are derived from the failure fractions in Table 6.2-3 for North slope failures that breach any trench. Damage Condition 1 accounts for any damage up to, but not exceeding, Damage Condition 2. The failure fractions in Table 6.2-3 and Table 6.2-4 are cumulative values for damage that exceeds each specified interval. Therefore, the failure fractions for Damage Condition 1 in Table 6.2-7 are derived by subtracting the Damage Condition 2 failure fractions from the total failure fractions in Table 6.2-3.

For example, consider the impacts from a 0.25 g earthquake that occurs under conditions of Low Soil Strength and Low Groundwater Level. Table 6.2-2 shows that there is a composite probability of 0.0125 that these "Low – Low" conditions apply at the SDA site over the next 30 years. Table 6.2-3 shows that 9% of these seismic events will result in some amount of trench intersection from the North slope (i.e., the cumulative failure fraction is 9.00E-02 for these conditions). Table 6.2-4 shows that 2% of these events will result in damage that breaches Trenches 1/2, 3, 8, and 9 (i.e., the failure fraction is 2.00E-02 for these conditions). Thus, for a 0.25 g seismic event under conditions of Low Soil Strength and Low Groundwater Level (probability = 0.0125), Table 6.2-7 lists a failure fraction of 2.00E-02 for Damage Condition 2. The failure fraction for Damage Condition 1 is the difference between the cumulative failure fraction for any damage, and the failure fraction for Damage Condition 2 (i.e., 9.00E-02 – 2.00E-02 = 7.00E-02). All other failure fractions in Table 6.2-7 were computed similarly.

6.2.4 References

- 6.2-1. WinSTABL, Version 2.40, Bosscher, P. J., and H. Bekta, University of Wisconsin, 2000
- 6.2-2. "Stability Evaluations of Slopes Adjoining the New York State-Licensed Disposal Area (SDA) Western New York Nuclear Service Center (WNYNSC) West Valley, New York", Aloysius, D. L. and A. J. Nello, Document #SLK0215:SEA-178, 1992
- 6.2-3. "Potential Leachate Level Changes after Installation of Geomembrane Cover at the New York State Licensed Low-Level Radioactive Waste Disposal Area (SDA) West Valley, New York", Dames and Moore, 1995

Table 6.2-1. SDA Soil Properties for Slope Stability Analyses				
Analysis Condition	Moist Unit Weight (pounds / cu. ft.)	Saturated Unit Weight (pounds / cu. ft.)	Cohesive Strength (pounds / sq. ft.)	Friction Angle (degrees)
Cover Soil				
Low	125	141	250	25
Nominal	120	135	500	27
High	115	131	1000	25
Weathered Till				
Low	125	141	100	20
Nominal	120	135	250	27
High	115	131	750	25
Waste				
Low	110	126	50	25
Nominal	95	110	250	27
High	85	100	300	30
Unweathered Till				
Low	120	135	500	25
Nominal	120	135	1000	27
High	120	135	1500	25

Table 6.2-2. Probability Weights for Slope Model Input Parameters				
		Groundwater Level		
		Low (0.0500)	Middle (0.9488)	High (0.0012)
Soil Strength	Low (0.25)	0.0125	0.2372	0.0003
	Nominal (0.65)	0.0325	0.6167	0.0008
	High (0.10)	0.0050	0.0949	0.0001

Table 6.2-3. SDA North Slope Seismic Failure Results (page 1 of 4)

Slope Conditions			Seismic Acceleration (g)	Fraction of Events with Breach Depth \geq X Feet					
Soil Strength	Groundwater Level	Probability		1	25	50	75	100	125
Low	Middle	0.2372	0.25	8.00E-02	4.50E-02	3.50E-02	3.50E-02	3.00E-02	2.00E-02
Low	Low	0.0125	0.25	9.00E-02	8.00E-02	5.00E-02	5.00E-02	3.00E-02	3.00E-02
Low	High	0.0003	0.25	7.50E-02	6.50E-02	5.00E-02	3.00E-02	2.50E-02	2.00E-02
Nominal	Middle	0.6167	0.25						
High	Middle	0.0949	0.25						
Nominal	Low	0.0325	0.25						
High	Low	0.0050	0.25						
Nominal	High	0.0008	0.25						
High	High	0.0001	0.25						
			0.25 Mean	2.01E-02	1.17E-02	8.94E-03	8.94E-03	7.50E-03	5.13E-03
Low	Middle	0.2372	0.35	8.00E-02	4.50E-02	3.50E-02	3.50E-02	3.00E-02	2.00E-02
Low	Low	0.0125	0.35	9.00E-02	8.00E-02	5.00E-02	5.00E-02	3.00E-02	3.00E-02
Nominal	High	0.0008	0.35	5.00E-03					
Low	High	0.0003	0.35	7.50E-02	6.50E-02	5.00E-02	3.00E-02	2.50E-02	2.00E-02
Nominal	Middle	0.6167	0.35						
High	Middle	0.0949	0.35						
Nominal	Low	0.0325	0.35						
High	Low	0.0050	0.35						
High	High	0.0001	0.35						
			0.35 Mean	2.01E-02	1.17E-02	8.94E-03	8.94E-03	7.50E-03	5.13E-03
Nominal	Middle	0.6167	0.50	8.00E-02	4.50E-02	3.50E-02	3.50E-02	3.00E-02	2.00E-02
Low	Middle	0.2372	0.50	8.00E-02	4.50E-02	3.50E-02	3.50E-02	3.00E-02	2.00E-02
Nominal	Low	0.0325	0.50	5.00E-03					
Low	Low	0.0125	0.50	9.00E-02	8.00E-02	5.00E-02	5.00E-02	3.00E-02	3.00E-02
Nominal	High	0.0008	0.50	8.50E-02	6.50E-02	5.50E-02	5.00E-02	3.50E-02	1.50E-02
Low	High	0.0003	0.50	7.50E-02	6.50E-02	5.00E-02	3.00E-02	2.50E-02	2.00E-02
High	Middle	0.0949	0.50						
High	Low	0.0050	0.50						
High	High	0.0001	0.50						
			0.50 Mean	6.84E-02	3.85E-02	2.99E-02	2.99E-02	2.57E-02	1.71E-02

Table 6.2-3. SDA North Slope Seismic Failure Results (page 2 of 4)

Slope Conditions		Seismic Acceleration (g)	Fraction of Events with Breach Depth \geq X Feet					
Soil Strength	Groundwater Level		Probability	150	175	200	225	250
Low	Middle	0.2372	0.25	1.00E-02	1.00E-02	1.00E-02	5.00E-03	
Low	Low	0.0125	0.25	2.00E-02	2.00E-02	1.50E-02		
Low	High	0.0003	0.25	2.00E-02	1.00E-02	5.00E-03		
Nominal	Middle	0.6167	0.25					
High	Middle	0.0949	0.25					
Nominal	Low	0.0325	0.25					
High	Low	0.0050	0.25					
Nominal	High	0.0008	0.25					
High	High	0.0001	0.25					
			0.25 Mean	2.63E-03	2.63E-03	2.56E-03	1.19E-03	
Low	Middle	0.2372	0.35	1.00E-02	1.00E-02	1.00E-02	5.00E-03	
Low	Low	0.0125	0.35	2.00E-02	2.00E-02	1.50E-02		
Nominal	High	0.0008	0.35					
Low	High	0.0003	0.35	2.00E-02	1.00E-02	5.00E-03		
Nominal	Middle	0.6167	0.35					
High	Middle	0.0949	0.35					
Nominal	Low	0.0325	0.35					
High	Low	0.0050	0.35					
High	High	0.0001	0.35					
			0.35 Mean	2.63E-03	2.63E-03	2.56E-03	1.19E-03	
Nominal	Middle	0.6167	0.50	1.00E-02	1.00E-02	1.00E-02	5.00E-03	
Low	Middle	0.2372	0.50	1.00E-02	1.00E-02	1.00E-02	5.00E-03	
Nominal	Low	0.0325	0.50					
Low	Low	0.0125	0.50	2.00E-02	2.00E-02	1.50E-02		
Nominal	High	0.0008	0.50	1.00E-02	1.00E-02	1.00E-02		
Low	High	0.0003	0.50	2.00E-02	1.00E-02	5.00E-03		
High	Middle	0.0949	0.50					
High	Low	0.0050	0.50					
High	High	0.0001	0.50					
			0.50 Mean	8.55E-03	8.55E-03	8.55E-03	4.27E-03	

Table 6.2-3. SDA North Slope Seismic Failure Results (page 3 of 4)										
Slope Conditions			Seismic Acceleration (g)	Fraction of Events with Breach Depth \geq X Feet						
Soil Strength	Groundwater Level	Probability		1	25	50	75	100	125	
Nominal	Middle	0.6167	0.70	8.00E-02	4.50E-02	3.50E-02	3.50E-02	3.00E-02	3.00E-02	2.00E-02
Low	Middle	0.2372	0.70	8.00E-02	4.50E-02	3.50E-02	3.50E-02	3.00E-02	3.00E-02	2.00E-02
Nominal	Low	0.0325	0.70	6.00E-02	4.50E-02	3.00E-02	2.50E-02	1.50E-02	1.50E-02	1.00E-02
Low	Low	0.0125	0.70	9.00E-02	8.00E-02	5.00E-02	5.00E-02	3.00E-02	3.00E-02	3.00E-02
Nominal	High	0.0008	0.70	8.50E-02	6.50E-02	5.50E-02	5.00E-02	3.50E-02	3.50E-02	1.50E-02
Low	High	0.0003	0.70	7.50E-02	6.50E-02	5.00E-02	3.00E-02	2.50E-02	2.50E-02	2.00E-02
High	Middle	0.0949	0.70							
High	Low	0.0050	0.70							
High	High	0.0001	0.70							
			0.70 Mean	7.03E-02	3.99E-02	3.09E-02	3.07E-02	2.61E-02	1.74E-02	
Nominal	Middle	0.6167	1.00	8.00E-02	4.50E-02	3.50E-02	3.50E-02	3.00E-02	3.00E-02	2.00E-02
Low	Middle	0.2372	1.00	8.00E-02	4.50E-02	3.50E-02	3.50E-02	3.00E-02	3.00E-02	2.00E-02
High	Middle	0.0949	1.00	1.30E-01	9.50E-02	8.50E-02	8.00E-02	6.50E-02	6.50E-02	3.50E-02
Nominal	Low	0.0325	1.00	6.50E-02	5.00E-02	3.50E-02	2.50E-02	1.50E-02	1.50E-02	1.00E-02
Low	Low	0.0125	1.00	9.00E-02	8.00E-02	5.00E-02	5.00E-02	3.00E-02	3.00E-02	3.00E-02
High	Low	0.0050	1.00	1.50E-01	1.15E-01	8.50E-02	7.50E-02	4.50E-02	4.50E-02	2.50E-02
Nominal	High	0.0008	1.00	8.50E-02	6.50E-02	5.50E-02	5.00E-02	3.50E-02	3.50E-02	1.50E-02
Low	High	0.0003	1.00	7.50E-02	6.50E-02	5.00E-02	3.00E-02	2.50E-02	2.50E-02	2.00E-02
High	High	0.0001	1.00	1.25E-01	8.00E-02	6.50E-02	6.00E-02	4.00E-02	4.00E-02	1.00E-02
			1.00 Mean	8.26E-02	4.91E-02	3.91E-02	3.85E-02	3.24E-02	2.09E-02	

Table 6.2-3. SDA North Slope Seismic Failure Results (page 4 of 4)										
Slope Conditions			Seismic Acceleration (g)	Fraction of Events with Breach Depth \geq X Feet						
Soil Strength	Groundwater Level	Probability		150	175	200	225	250		
Nominal	Middle	0.6167	0.70	1.00E-02	1.00E-02	1.00E-02	5.00E-03			
Low	Middle	0.2372	0.70	1.00E-02	1.00E-02	1.00E-02	5.00E-03			
Nominal	Low	0.0325	0.70	5.00E-03	5.00E-03	5.00E-03	5.00E-03			
Low	Low	0.0125	0.70	2.00E-02	2.00E-02	1.50E-02				
Nominal	High	0.0008	0.70	1.00E-02	1.00E-02	1.00E-02				
Low	High	0.0003	0.70	2.00E-02	1.00E-02	5.00E-03				
High	Middle	0.0949	0.70							
High	Low	0.0050	0.70							
High	High	0.0001	0.70							
			0.70 Mean	8.71E-03	8.71E-03	8.71E-03	4.43E-03			
Nominal	Middle	0.6167	1.00	1.00E-02	1.00E-02	1.00E-02	5.00E-03			
Low	Middle	0.2372	1.00	1.00E-02	1.00E-02	1.00E-02	5.00E-03			
High	Middle	0.0949	1.00	2.50E-02	2.50E-02	2.50E-02	1.50E-02			
Nominal	Low	0.0325	1.00	5.00E-03	5.00E-03	5.00E-03	5.00E-03			
Low	Low	0.0125	1.00	2.00E-02	2.00E-02	1.50E-02				
High	Low	0.0050	1.00	2.50E-02	5.00E-03					
Nominal	High	0.0008	1.00	1.00E-02	1.00E-02	1.00E-02				
Low	High	0.0003	1.00	2.00E-02	1.00E-02	5.00E-03				
High	High	0.0001	1.00							
			1.00 Mean	1.13E-02	1.12E-02	1.11E-02	5.69E-03			

Table 6.2-4. SDA East Slope (North End) Seismic Failure Results (page 1 of 2)

Slope Conditions			Seismic Acceleration (g)	Fraction of Events with Breach \geq		
Soil Strength	Groundwater Level	Probability		Trenches 1/2	Trench 3	Trench 4
Low	Middle	0.2372	0.25	3.00E-02	2.00E-02	
Low	Low	0.0125	0.25	3.00E-02	2.00E-02	
Low	High	0.0003	0.25	3.00E-02	1.50E-02	
Nominal	Middle	0.6167	0.25			
High	Middle	0.0949	0.25			
Nominal	Low	0.0325	0.25			
High	Low	0.0050	0.25			
Nominal	High	0.0008	0.25			
High	High	0.0001	0.25			
			0.25 Mean	7.50E-03	5.00E-03	
Low	Middle	0.2372	0.35	3.00E-02	2.00E-02	
Low	Low	0.0125	0.35	3.00E-02	2.00E-02	
Low	High	0.0003	0.35	3.00E-02	1.50E-02	
Nominal	Middle	0.6167	0.35			
High	Middle	0.0949	0.35			
Nominal	Low	0.0325	0.35			
High	Low	0.0050	0.35			
Nominal	High	0.0008	0.35			
High	High	0.0001	0.35			
			0.35 Mean	7.50E-03	5.00E-03	
Nominal	Middle	0.6167	0.50	5.00E-02	3.50E-02	
Low	Middle	0.2372	0.50	3.50E-02	2.00E-02	
Nominal	Low	0.0325	0.50	2.50E-02	2.00E-02	
Low	Low	0.0125	0.50	3.00E-02	2.00E-02	
Nominal	High	0.0008	0.50	6.50E-02	4.50E-02	
Low	High	0.0003	0.50	3.00E-02	1.50E-02	
High	High	0.0001	0.50	4.00E-02	1.00E-02	
High	Middle	0.0949	0.50			
High	Low	0.0050	0.50			
			0.50 Mean	4.04E-02	2.73E-02	
Nominal	Middle	0.0617	0.70	5.00E-02	3.50E-02	
Low	Middle	0.2372	0.70	3.50E-02	2.00E-02	
High	Middle	0.0949	0.70	6.50E-02	5.00E-02	
Nominal	Low	0.0325	0.70	6.00E-02	4.50E-02	
Low	Low	0.0125	0.70	3.00E-02	2.00E-02	
High	Low	0.0050	0.70	6.50E-02	5.00E-02	
Nominal	High	0.0008	0.70	7.00E-02	5.00E-02	
Low	High	0.0003	0.70	3.00E-02	1.50E-02	
High	High	0.0001	0.70	6.00E-02	2.50E-02	
			0.70 Mean	4.80E-02	3.31E-02	

Table 6.2-4. SDA East Slope (North End) Seismic Failure Results (page 2 of 2)

Slope Conditions			Seismic Acceleration (g)	Fraction of Events with Breach \geq		
Soil Strength	Groundwater Level	Probability		Trenches 1/2	Trench 3	Trench 4
Nominal	Middle	0.6167	1.00	5.00E-02	3.50E-02	
Low	Middle	0.2372	1.00	3.50E-02	2.00E-02	
High	Middle	0.0949	1.00	6.50E-02	5.00E-02	
Nominal	Low	0.0325	1.00	6.00E-02	4.50E-02	
Low	Low	0.0125	1.00	3.00E-02	2.00E-02	
High	Low	0.0050	1.00	6.50E-02	5.00E-02	
Nominal	High	0.0008	1.00	7.00E-02	5.00E-02	
Low	High	0.0003	1.00	3.00E-02	1.50E-02	
High	High	0.0001	1.00	6.00E-02	2.50E-02	
			1.00 Mean	4.80E-02	3.31E-02	

Table 6.2-5. SDA East Slope (South End) Seismic Failure Results (page 1 of 2)

Slope Conditions			Seismic Acceleration (g)	Fraction of Events with Breach \geq		
Soil Strength	Groundwater Level	Probability		Trench 8	Trench 9	Trench 10
Low	High	0.0003	0.25	2.00E-02	1.50E-02	
Nominal	Middle	0.6167	0.25			
Low	Middle	0.2372	0.25			
High	Middle	0.0949	0.25			
Nominal	Low	0.0325	0.25			
Low	Low	0.0125	0.25			
High	Low	0.0050	0.25			
Nominal	High	0.0008	0.25			
High	High	0.0001	0.25			
			0.25 Mean	6.00E-06	4.50E-06	
Low	Middle	0.2372	0.35	2.00E-02	1.50E-02	
Low	Low	0.0125	0.35	2.00E-02	1.50E-02	
Low	High	0.0003	0.35	2.00E-02	1.50E-02	
Nominal	Middle	0.6167	0.35			
High	Middle	0.0949	0.35			
Nominal	Low	0.0325	0.35			
High	Low	0.0050	0.35			
Nominal	High	0.0008	0.35			
High	High	0.0001	0.35			
			0.35 Mean	5.00E-03	3.75E-03	
Low	Middle	0.2372	0.50	2.00E-02	1.50E-02	
Low	Low	0.0125	0.50	2.00E-02	1.50E-02	
Nominal	High	0.0008	0.50	5.50E-02	2.50E-02	
Low	High	0.0003	0.50	2.00E-02	1.50E-02	
Nominal	Middle	0.6167	0.50			
High	Middle	0.0949	0.50			
Nominal	Low	0.0325	0.50			
High	Low	0.0050	0.50			
High	High	0.0001	0.50			
			0.50 Mean	5.04E-03	3.77E-03	
Nominal	Middle	0.6167	0.70	4.50E-02	3.50E-02	
Low	Middle	0.2372	0.70	2.00E-02	1.50E-02	
High	Middle	0.0949	0.70	3.00E-02	2.00E-02	
Nominal	Low	0.0325	0.70	4.50E-02	3.50E-02	
Low	Low	0.0125	0.70	2.00E-02	1.50E-02	
High	Low	0.0050	0.70	2.00E-02	2.00E-02	
Nominal	High	0.0008	0.70	5.50E-02	2.50E-02	
Low	High	0.0003	0.70	2.00E-02	1.50E-02	
High	High	0.0001	0.70	5.00E-02	3.50E-02	
			0.70 Mean	3.72E-02	2.85E-02	

Table 6.2-5. SDA East Slope (South End) Seismic Failure Results (page 2 of 2)

Slope Conditions			Seismic Acceleration (g)	Fraction of Events with Breach \geq		
Soil Strength	Groundwater Level	Probability		Trench 8	Trench 9	Trench 10
Nominal	Middle	0.6167	1.00	5.00E-02	3.50E-02	
Low	Middle	0.2372	1.00	2.00E-02	1.50E-02	
High	Middle	0.0949	1.00	5.00E-02	3.50E-02	
Nominal	Low	0.0325	1.00	4.50E-02	3.50E-02	
Low	Low	0.0125	1.00	2.00E-02	1.50E-02	
High	Low	0.0050	1.00	5.00E-02	3.50E-02	
Nominal	High	0.0008	1.00	5.50E-02	2.50E-02	
Low	High	0.0003	1.00	2.00E-02	1.50E-02	
High	High	0.0001	1.00	5.50E-02	4.00E-02	
			1.00 Mean	4.23E-02	3.00E-02	

Table 6.2-6. Correlation of North Slope and East Slope Failures						
Acceleration (g)	Extent of Breach	Mean Failure Fraction	Extent of Breach	Mean Failure Fraction	Extent of Breach	Mean Failure Fraction
0.25	Only North ends of Trenches 1/2, 3, 4, 5 from 0 – 75 feet	1.26E-02	Trenches 1/2 and 8, and North ends of Trenches 3, 4, 5 from 76 – 125 feet	2.50E-03	Trenches 1/2, 3, 8, and 9, and North ends of Trenches 4, 5 from 126 – 250 feet	5.00E-03
0.35	Only North ends of Trenches 1/2, 3, 4, 5 from 0 – 75 feet	1.26E-02	Trenches 1/2 and 8, and North ends of Trenches 3, 4, 5 from 76 – 125 feet	2.50E-03	Trenches 1/2, 3, 8, and 9, and North ends of Trenches 4, 5 from 126 – 250 feet	5.00E-03
0.50	Only North ends of Trenches 1/2, 3, 4, 5 from 0 – 25 feet	2.80E-02	Trenches 1/2 and 8, and North ends of Trenches 3, 4, 5 from 26 – 75 feet	1.31E-02	Trenches 1/2, 3, 8, and 9, and North ends of Trenches 4, 5 from 76 – 250 feet	2.73E-02
0.70	Only North ends of Trenches 1/2, 3, 4, 5 from 0 – 25 feet	2.23E-02	Trenches 1/2 and 8, and North ends of Trenches 3, 4, 5 from 26 – 50 feet	1.49E-02	Trenches 1/2, 3, 8, and 9, and North ends of Trenches 4, 5 from 51 – 250 feet	3.31E-02
1.00	Only North ends of Trenches 1/2, 3, 4, 5 from 0 – 25 feet	3.46E-02	Trenches 1/2 and 8, and North ends of Trenches 3, 4, 5 from 26 – 75 feet	1.49E-02	Trenches 1/2, 3, 8, and 9, and North ends of Trenches 4, 5 from 76 – 250 feet	3.31E-02

Table 6.2-7. Seismic Slope Failure Fragilities for SDA Risk Models

Seismic Acceleration (g)	Damage Condition 1		Damage Condition 2	
	Failure Fraction	Probability	Failure Fraction	Probability
0.25 – 0.35	7.00E-02	0.0125	2.00E-02	0.0125
	6.00E-02	0.2372	2.00E-02	0.2372
	6.00E-02	0.0003	1.50E-02	0.0003
	0	0.7500	0	0.7500
0.35 – 0.50	7.00E-02	0.0125	2.00E-02	0.0125
	6.00E-02	0.2372	2.00E-02	0.2372
	6.00E-02	0.0003	1.50E-02	0.0003
	5.00E-03	0.0008		
	0	0.7492	0	0.7500
0.50 – 0.70	7.00E-02	0.0125	2.00E-02	0.0125
	6.00E-02	0.2372	2.00E-02	0.2372
	6.00E-02	0.0003	1.50E-02	0.0003
	4.50E-02	0.6167	3.50E-02	0.6167
	4.00E-02	0.0008	4.50E-02	0.0008
	0	0.1325	2.00E-02	0.0325
			1.00E-02	0.0001
			0	0.0999
0.70 – 1.00	7.00E-02	0.0125	2.00E-02	0.0125
	6.00E-02	0.2372	2.00E-02	0.2372
	6.00E-02	0.0003	1.50E-02	0.0003
	4.50E-02	0.6167	3.50E-02	0.6167
	3.50E-02	0.0008	5.00E-02	0.0008
	1.50E-02	0.0325	4.50E-02	0.0325
	0	0.1000	5.00E-02	0.0949
			5.00E-02	0.0050
			2.50E-02	0.0001

Table 6.2-7. Seismic Slope Failure Fragilities for SDA Risk Models

Seismic Acceleration (g)	Damage Condition 1		Damage Condition 2	
	Failure Fraction	Probability	Failure Fraction	Probability
> 1.00	1.00E-01	0.0050	5.00E-02	0.0050
	1.00E-01	0.0001	2.50E-02	0.0001
	8.00E-02	0.0949	5.00E-02	0.0949
	7.00E-02	0.0125	2.00E-02	0.0125
	6.00E-02	0.2372	2.00E-02	0.2372
	6.00E-02	0.0003	1.50E-02	0.0003
	4.50E-02	0.6167	3.50E-02	0.6167
	3.50E-02	0.0008	5.00E-02	0.0008
	2.00E-02	0.0325	4.50E-02	0.0325

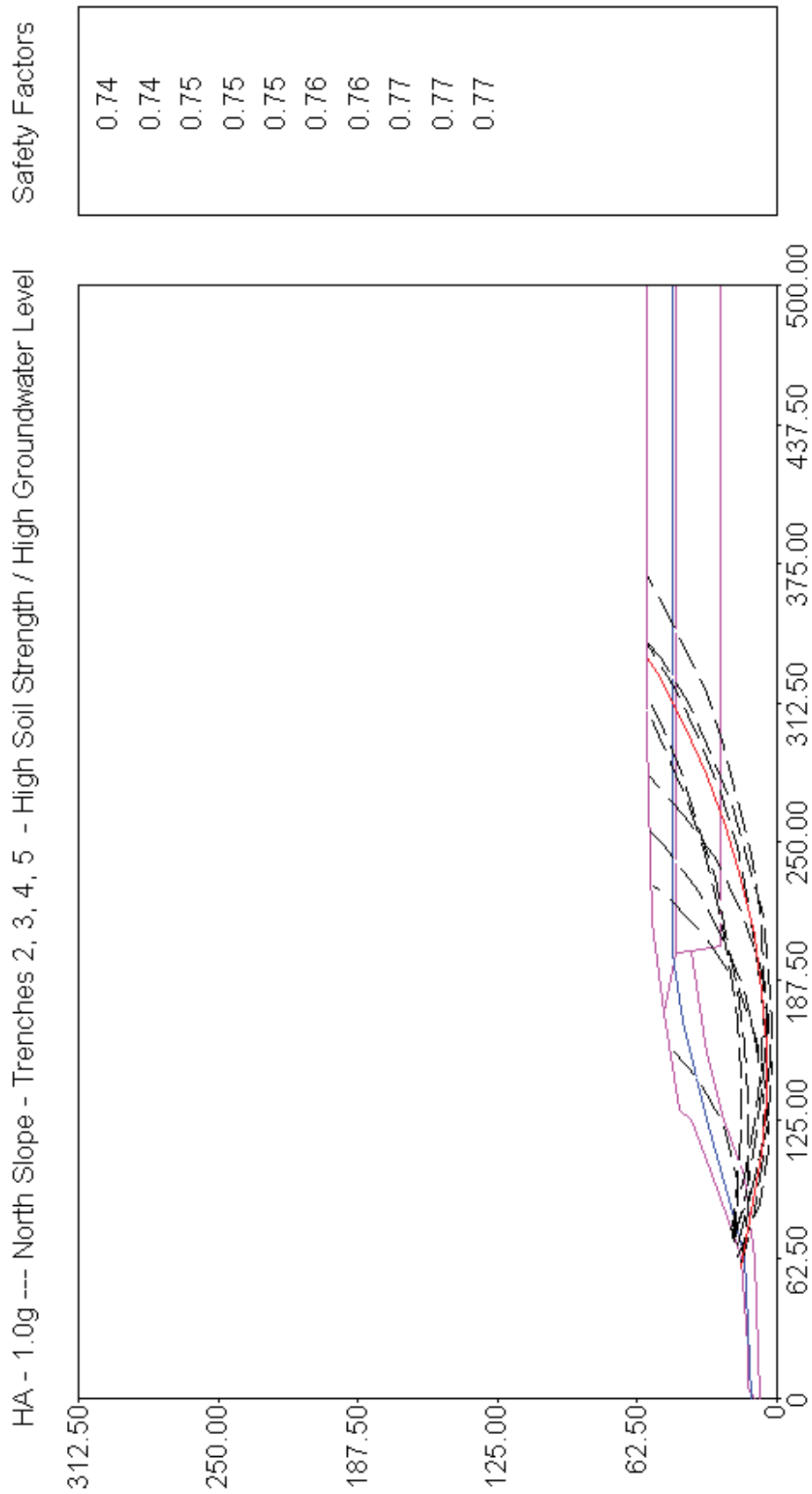

Figure 6.2-1. Plot of WinSTABL Critical Failure Surfaces

HA - 1.0g --- North Slope - Trenches 2, 3, 4, 5 - High Soil Strength / High Groundwater Level

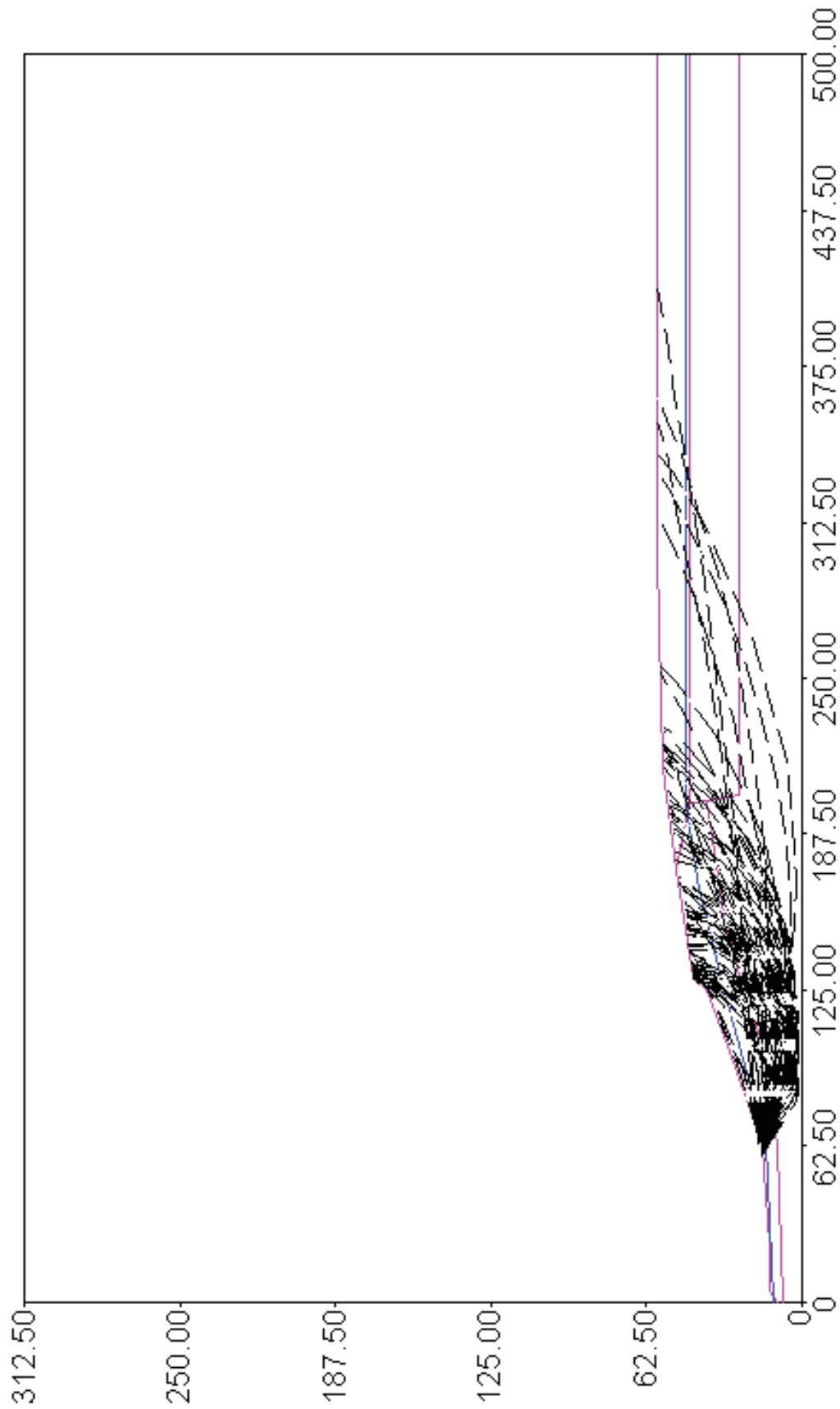

Figure 6.2-2. Plot of WinSTABL Other Surfaces

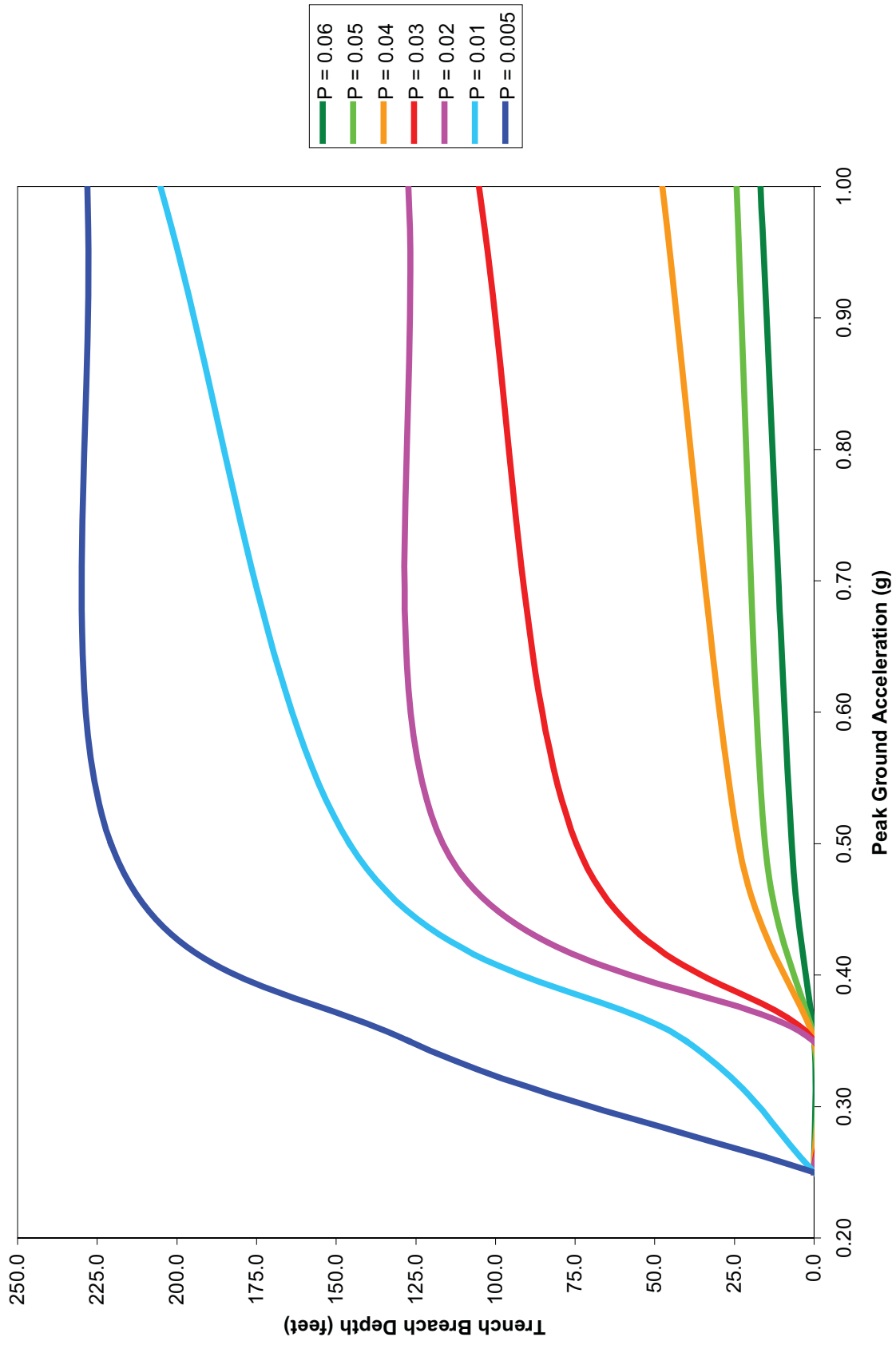

Figure 6.2-3. SDA North Slope Seismic Fragility Curves

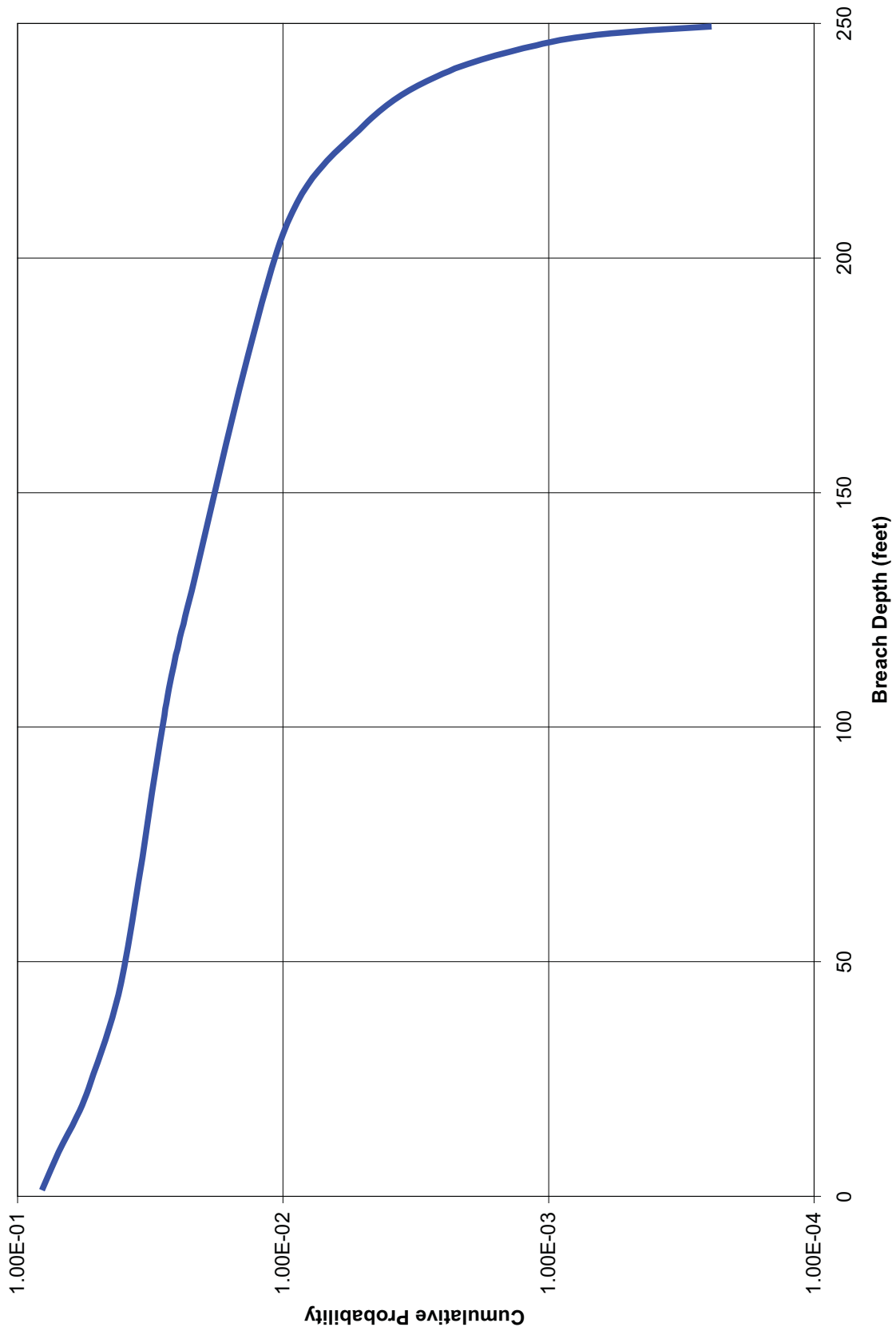

Figure 6.2-4. Trench Breach Depth Cumulative Probability, SDA North Slope, Acceleration = 1.0 g

6.3 LANDSLIDES FROM NON-SEISMIC CAUSES

The analyses described in this section were performed by Dr. Michael P. Wilson and Dr. Robert H. Fakundiny and were submitted to the QRA team as part of the expert elicitation inputs for the study. Except for editorial formatting, the material in Sections 6.3.1 and 6.3.2 is reproduced verbatim from their report (Reference 6.3-1). Section 6.3.3 summarizes the QRA team's interpretation of these analyses and explains how the results are applied in the risk assessment models.

6.3.1 Localized Failures of SDA Slopes

6.3.1.1 Purpose and Scope

We were asked during the elicitation exercise of 7-21-08 through 7-23-08 to consider the probability for landsliding on the perimeter of the SDA trenches and in the trench walls, as well as SDA whole-site movement in the context of a larger, more-regional landslide event that could disrupt the site. Our task was to consider landsliding during the next 30 years without future gullying or seismic events; our concern for this task was for landslides under any other existing conditions (broadly interpreted).

We have extensive knowledge of the site conditions, background literature, field conditions, history of site investigations, results of landslide studies in the region around the site and our personal observations. NYSERDA staff, and IERT and QRA teams, provided additional expertise to discuss questions, and to provide comments and records during our elicitation. Additionally, Steve Wampler provided a set of slope stability analyses using WinSTABL-2.40 software with parameters from site cross-sections and site or other literature.

The following documents and records were analyzed during the 3-day period: References 6.3-2 through 6.3-7.

6.3.1.2 Data Evaluation

Geotechnical data for the site were adequate for our current purposes. More geotechnical data will be helpful in the future for other NYSERDA projects or interests, such as soil-strength properties for long-term site performance.

Most available data represent values of parameters expected to be constant into the future. We expect values measured in the past decades to be about the same in the next 30 years for geometry of slopes, geologic layers, unit weights, friction angles, cohesion, pore pressure and water levels. The exceptions are human or gully modification of slopes, seismic additions of forces, and effects of soil-fracture growth from dewatering. NYSERDA will avoid or mitigate human modification of slopes, and gully and earthquake-seismic effects will be evaluated separately from this report. Effects of fracture growth cannot be investigated in the time frame of this report, and therefore, will be estimated conservatively with our professional judgment.

We reviewed the results of modeling by Steve Wampler to evaluate trench susceptibility to landslides, for example Figure 6.3-1. He used WinSTABL-2.40 software, on the basis of the modified-Bishop approach to slip-circle analysis. He provided cross-sections depicting the ten worst-case slip-circles and factors of safety for each of nine categories combining low, nominal

and high strengths (cohesion), with low-, middle- and high-water tables. Wampler also assigned probabilities to the physical conditions of strengths (cohesion) and groundwater levels (Table 6.3-1).

Steve Wampler was able to immediately conduct modeling for very low cohesive strengths with water tables at ground surface, upon request. We made this request because there was some conflicting evidence regarding soil strength (cohesion) in addition to our concerns about fracture growth in drying soils. A worst-case condition might be dewatering of SDA trenches that initiates fractures and allows those fractures to expand, and then precipitation or other conditions re-saturate them. Fickies and others (Reference 6.3-3) found lab evidence from sampling at the site for fracture healing upon rewetting, but their and our field observations show open fractures and increased hydraulic conductivities in fractured Lavery Till. The conflicting evidence for cohesion values is that Fickies and others (Reference 6.3-3, p. 9) estimate cohesions of 4,000 to 6,000 psf in weathered till, 3,000 psf in unweathered till, while Aloysius and Nello (Reference 6.3-2, p. 6) estimate cohesion as 500 psf, and test boring logs indicate weathered and unweathered tills having standard-penetration-test values of (commonly) 5 to 15 for weathered till and only 1 to 9 for unweathered till. The contact between the weathered and unweathered till cannot be distinguished within the extremely low blow counts throughout the Lavery Till. Near-vertical trench walls tens of feet high remained intact during excavation. The North-slope of the SDA was mapped in 1982, however, as a landslide about 180 ft by 60 ft and 20 ft high. The current surface, which has smoothed through time, has topographic undulations that most likely resulted from renewed creep or shallow-sliding. Wampler's very low-strength slip-circle-diagrams, which use Factors of Safety between 0.76 and 1.19, depicted few circles very close to trenches.

6.3.1.3 Evaluation of Slip-Circle Results

The lowest factors of safety are given for Wampler's nine conditions of strength and groundwater levels in Table 6.3-2. We are correlating Wampler's "dry" trench, medium-level trench water, and full-trench water with the three conditions of unsaturated till (low rainfall), partly saturated till (moderate rainfall), and total-soil saturation (high rainfall or seasonal snow melt), respectively. Slip-circles (possible rotational failure planes) with FS of less than one will theoretically fail. Common practice, however, is to use a FS of 1.5 as the acceptable level of risk, and thus, account for uncertainties in input parameters and method of analysis. Those values are recalibrated to a basis of 1.0, and thus, adjusted to include uncertainty when we divide the FS values by 1.5. The adjusted values of FS for all groundwater conditions are above 1.0, and the probability for landslide is zero when strengths are nominal or high. The adjusted FS values are 0.95, 0.89 and 0.79 for low-, middle- and high-groundwater levels, respectively, when strength is low. We consider probable that a failure plane will occur on the circles predicted by the modified-Bishop method. We decided to consider a value of adjusted FS of zero as having a 100% probability of failure and adjusted FS of 1.0 as having a 0% probability for the purposes of suggesting a probability for occurrences of failure planes. Thus, we used the reciprocal values of adjusted FS as the probability for occurrence of a failure plane. The probability of low strength at low-, middle- and high-water tables yielding a plane of failure is 5%, 11% and 21%, respectively. Table 6.3-3 gives the probabilities for occurrence of slip-circles (failure planes) including uncertainties of methods and parameters.

Table 6.3-4 gives the probabilities for slope failure as we multiplied Wampler's table of probabilities for critical-physical-condition variations (Table 6.3-1) times Table 6.3-3 values for probability of occurrences of failure planes.

Next, we weighted the above values according to the distances between the winSTABL-2.40-modeled slip-circles and the trench walls. One could argue that probability of landslides reaching the trenches within 30 years is zero, because the low FS slip-circles do not reach the trench walls, and reduce all values in Table 6.3-4 to zero. We are concerned, however, that changes in properties or conditions may be caused by changes in unaccounted processes, particularly fracture enlargement or frequency increases caused by dewatering. We weighted the probabilities in Table 6.3-4 to be greater than zero and, thus, by using several distance criteria, especially the horizontal distance from the trench top to the closest, low-FS slip circle, we constructed Table 6.3-5, the probability of trench failure by landslides. We used 0.1 for low- and high-water levels (short slip-circle to trench distances) and 0.05 for middle-water levels (longer distances), rather than using zero for probability resulting from distance. These weightings were chosen to cause final probabilities to approach values between 0.1% and 1% as our overall level of concern for landslide effects on trenches. Multiplying these values times Table 6.3-4 values yields Table 6.3-5 values.

6.3.1.4 Discussion

The modeled slip-circles, taken at face value, result in zero probability of landslides reaching the trenches. Our regional and local experiences convince us that some probability for trench failure exists. We have used an analysis of the process of failure and methods of assigning slip-circles and FS to derive probabilities greater than zero for landslides intersecting trenches. Our probabilities are aimed at a conservative 30-year analysis; our results should not be directly used for longer time predictions without reevaluation.

6.3.2 A Regionally Disruptive Landslide

A "global" landslide took place in 2007 (and continuing) about three miles from the SDA (Reference 6.3-5) at Scoby Hill, south of Springville, NY. This slide was global in the sense of large size, and if it occurred at the SDA, it could carry and disrupt much or all of the SDA, and adjacent areas. The Scoby Hill landslide is 1,000 m (3,300 ft) by 400 m (1,300 ft) in area.

LaFleur mapped (Reference 6.3-4) many large areas of landslides in the four and a half quadrangles surrounding the SDA, but those maps don't show the size of individual slide blocks. The incidence of the Scoby Hill landslide confirms that global landslides may occur. Factors that contribute to the Scoby Hill slide are present in the vicinity of the SDA such as an adjacent steep slope 160 ft high (Buttermilk Creek valley wall), a possible deep failure-plane if the slide were to be translational (Kent Recessional deposits, for example), a possible thick failure-material if the slide were to be rotational (clayey Lavery Till, for example), and the same climate as Scoby Hill. The principal differences between the two sites (based on what is currently known about the Scoby Hill site) is that the Scoby Hill landslide is thought to be in response to the added weight of an artificially constructed berm on top of a previously failed deposit (old landslide).

These two factors (added berm and previous failure) are not present at the SDA (the South Plateau). We can conclude that in the next 30 years there is near-zero probability for a global-scale landslide, provided (1) no large weights are added to the plateau top, (2) Buttermilk Creek does not erode toward the site, and (3) climate change does not significantly raise the water table. NYSERDA can manage the site to prevent the addition of a large weight. Buttermilk is

not likely to move far in 30 years. While climate could raise the water table, the water table is already near the surface and in places at the surface.

When giving low, medium and high probabilities for an SDA global landslide, the probabilities are dependent on climate and Buttermilk Creek erosion altering what otherwise might be viewed as a size-dependent random event. First, we'll place a probability on the size-dependent random event, then weight it for water table change and Buttermilk erosion.

Scanning LaFleur's maps that include areas of old landslide deposits, we estimate LaFleur's mapped-areas of landslides as covering 5% of the area within a circle 5 miles in radius drawn on the maps. About 50% of the mapped slide areas are sufficiently wide to accommodate a global-size feature such as Scoby Hill and only about 20% of these are outside the immediate Cattaraugus Creek valley. Thus the probability of a random global slide at the SDA is 0.5%. We multiply 0.5% by one-in-10,000 to get a probability of occurrence of 0.0000005 per year, or 0.000015 in 30 years, estimating that these slides occurred over a time of 10,000 years.

Using a probability of high water table as 15% yields a weight of 0.15. The rate of lateral-shifting of Buttermilk is episodic, possibly in the range of 10 feet per-year to 1 foot per-century. Considering the maximum that it could have moved in map view through about 10,000 years as 1,000 feet, yields a weight of 0.1. If its creek channel lateral-movement was less and the plateau edge retreated more in response to landslides, then the weight should be less, such as 0.01 or 0.001. Combining water table and Buttermilk-erosion values yields a range of weights of 0.015 (high) to 0.00015 (low), with a moderate value at 0.0015. These values for weightings yield final probabilities of 0.00000023 (high), 0.00000023 (mid), and 0.000000023 (low).

6.3.3 Extension and Application of the Analyses

The following sections summarize the QRA team's interpretations of the landslide analyses and explain how the results are applied in the SDA risk assessment models.

6.3.3.1 Localized Slope Failures

The analyses in Section 6.3.1 cite specific examples from evaluations of the slopes at the North end of the SDA site, adjacent to Erdman Brook. The QRA team also performed similar evaluations of the slopes at the East side of the site, along Frank's Creek. The analyses confirm that the lowest Factor of Safety (FS) values apply for conditions of Low Soil Strength. All calculated FS values are greater than 1.0, indicating that no slope failures will occur under nominal environmental conditions. Table 6.3-6 summarizes the ten lowest FS values for each of the three analyzed slope sections. The "Fraction" entries in the table account for the fraction of the ten critical failure surfaces with each respective FS value. The table also lists the final probability weights assigned to each combination of soil strength and groundwater level conditions, accounting for the updated trench water level analyses that are summarized in Section 6.7.

The analyses in Section 6.3.1 use the following method to account for the experts' concerns about uncertainties in the baseline slope analyses and the evolution of processes that could affect site soil conditions during the 30-year period of the SDA risk assessment.

- An adjusted FS value is derived to account for additional factors of safety that are commonly applied in design-basis analyses. The adjusted FS value is equal to the baseline computed FS value, divided by 1.5.
- An increased likelihood of slope failure under the evaluated conditions is estimated from the difference between the adjusted FS value and unity.
- Weights are assigned to account for the likelihood that the computed failure surfaces may intersect the trenches, if a slope failure occurs. These weights account for the potential effects from changes in soil properties, or conditions that may be caused by unaccounted processes (e.g., fracture enlargement or dewatering). A weight of 0.10 was applied for each of the Low Groundwater Level and High Groundwater Level conditions, and a weight of 0.05 was applied for the Middle Groundwater Level condition.

For example, suppose that the WinSTABL evaluation results indicate that the lowest FS value for the conditions of Low Soil Strength and Middle Groundwater Level is 1.30. There is substantial margin to slope failure under these baseline conditions. The experts' adjusted FS value would be $1.30 / 1.50 = 0.87$. This adjusted FS value is then correlated to a 13% likelihood of slope failure under the baseline conditions ($1.00 - 0.87 = 0.13$). A weight of 0.05 is applied to account for the possibility that some slope failure surfaces may intersect the trenches, due to evolving processes that may alter the baseline Low Soil Strength, Middle Groundwater Level conditions. The composite likelihood that a slope failure may occur during the 30-year period of this study, and the failure surface will intersect the waste trenches is $0.13 * 0.05 = 6.5E-03$.

Application of the first two steps of this method to the ten lowest FS values for each of the three slope sections in Table 6.3-6 produces the results shown in Table 6.3-7. According to the analyses in Section 6.3.1, these results are interpreted as the likelihood that a slope failure will occur at some time during the 30-year SDA risk assessment period. Each value in Table 6.3-7 applies for the site condition of Low Soil Strength and the respective groundwater level.

The extended analyses show that the northern end of the East slope, between Frank's Creek and Trenches 1/2, is most vulnerable to these landslide failures. The North slope is next most vulnerable, and the southern end of the East slope is least likely to fail. The functional impacts from these slope failures are evaluated as follows in the SDA risk assessment models.

- It is assumed that failures of the entire East slope are determined by the analyses of the northern end of that slope. This assumption introduces some numerical conservatism, because the southern end of the slope is less vulnerable to these failures. However, it is also likely that a large landslide in either section will have some effect on the entire slope. Thus, damage from East slope landslides is assumed to affect Trenches 1/2 and Trench 8.
- It is assumed that failures of the North slope are fully correlated with failures of the East slope. This assumption introduces some numerical conservatism, because the North slope is somewhat less vulnerable to these failures. However, it is also likely that a large landslide in the northern section of the East slope will affect at least the northeast corner of the trench area, and may extend some distance along Erdman Brook. Thus, damage from East slope landslides is assumed to affect the north ends of Trenches 3, 4, and 5.

As noted in Section 6.3.1, there is also uncertainty about whether the failure surface will intersect the waste trenches, if a landslide occurs. Table 6.3-8 shows the total fraction of failure surfaces that intersect the trenches from the seismic analyses described in Section 6.2 (derived from the detailed results in Tables 6.2-3 through 6.2-5). For example, the information in Table 6.3-8 is interpreted as follows. If a slope failure occurs under conditions of Low Water Level, there is a probability of 3.7% that 1 of the 200 possible surfaces will intersect at least one of the waste trenches ($1 / 200 = 5.0E-03$). There is 18.5% probability that 4 of the 200 possible failure surfaces will intersect at least one trench ($4 / 200 = 2.0E-02$), and so forth.

The three probability distributions in Table 6.3-8 were used as prior information for Bayesian analyses that account for the experts' judgment regarding the intersection fractions. In particular, the experts estimated that 10% of the failure surfaces may intersect the trenches under Low Groundwater Level and High Groundwater Level conditions, and 5% of the surfaces may intersect the trenches under Middle Groundwater Level conditions. Table 6.3-9 shows the results from updating the prior information with these estimates.

As noted above, the limiting results for the northern end of the East slope are used in this analysis to evaluate the landslide behavior for all slope sections. The composite likelihood that a localized landslide will occur at some time during the 30-year study period, and the slope failure surface will intersect the waste trenches, is quantified by combining the distributions for failure of the northern end of the East slope in Table 6.3-7 with the trench intersection distributions in Table 6.3-9, each weighted by the probability of the respective site conditions. For example, the probability that Low Soil Strength and Low Groundwater Level conditions apply at the SDA site is $0.25 * 0.05 = 0.0125$. The entries in Table 6.3-7 show the likelihood that the northern end of the East slope will experience a landslide at some time during the next 30 years if these "Low – Low" conditions apply (e.g., 10% of the adjusted FS values yield a failure likelihood of 0.15). The entries in Table 6.3-9 show the fraction of failure surfaces that will intersect the trenches if the landslide occurs under conditions of Low Groundwater Level (e.g., 0.007 probability that $5.00E-03$ of the failures intersect a trench). Thus, the contribution from Low Soil Strength and Low Groundwater Level is the product of the failure likelihood from Table 6.3-7 and the trench intersection fraction from Table 6.3-9, multiplied by the probability of 0.0125 that these particular "Low – Low" conditions apply at the site.

The combined results from these calculations for all soil strengths and all groundwater levels are summarized below.

"Localized" Landslide Likelihood in 30 Years				
5th Percentile	Median	Mean	95th Percentile	Error Factor
3.62E-06	1.43E-03	1.73E-03	5.14E-03	37.7

It is convenient to represent these results by an equivalent annual frequency, to facilitate their combination with other contributors to the SDA risk. Therefore, the cumulative 30-year likelihoods shown above are divided by 30 to convert them to equivalent average annual frequencies. In summary, the effects from localized slope landslides, due to causes other than seismic failures and erosive gullying, are characterized by the following uncertainty distribution, derived from the results for the northern end of the East slope.

"Localized" Landslide* Frequency (event / year)				
5th Percentile	Median	Mean	95th Percentile	Error Factor
1.21E-07	4.77E-05	5.77E-05	1.71E-04	37.7
* Landslide due to all causes, except seismic failures and gully erosion				

The damage from these landslides intersects Trenches 1/2, Trench 8, and the north ends of Trenches 3, 4, and 5.

6.3.3.2 Regionally Disruptive Landslide

The analyses in Section 6.3.2 estimate a nominal frequency of 5.0E-07 event per year for a "random global" landslide, based on examinations of regional maps and evidence of historic landslide experience. To account for uncertainties in this estimate, the QRA team applied it as the median value of a lognormal uncertainty distribution with an error factor of 10. The median value is typically used to characterize "best estimates" from experts. An error factor of 10 is generally representative of the large uncertainties in estimates for these types of rare natural phenomena. This process provides the following uncertainty distribution for the "random global" landslide frequency.

"Random Global" Landslide Frequency (event / year)				
5th Percentile	Median	Mean	95th Percentile	Error Factor
5.00E-08	5.00E-07	1.33E-06	5.00E-06	10

The analyses in Section 6.3.2 adjust this frequency to account for specific factors that may apply to the SDA site (e.g., potential effects from the site water table and erosion of the Buttermilk Creek basin).

The experts indicate that high water table conditions at the SDA site correspond to an applied numerical adjustment factor of 0.15. Section 6.3.2 does not clearly describe the experts' basis for this factor. The QRA team considered two possible conditions.

- The experts believe there is 15% probability that the site water table is high, and the corresponding frequency adjustment factor is 1.0 for this condition.
- The experts are fully confident that the site water table is high, and the corresponding frequency adjustment factor is 0.15 for this condition.

These interpretations have different numerical effects when the respective uncertainty distributions are combined. Based on the analyses in Section 6.3.2, the QRA team applied the second interpretation, because it is clear that the experts' intent is to reduce the "random" landslide frequency by a numerical factor of 0.15 to account for the site-specific water table conditions.

Three potential effects from lateral erosion of Buttermilk Creek are considered. The analyses clearly indicate how these effects are applied to adjust the "random" landslide frequency. However, the analyses do not document the experts' confidence about each physical condition that is used to justify the erosion adjustment factors. The QRA team interpreted the information in Section 6.3.2 as follows.

- If the lateral erosion of Buttermilk Creek is on the order of approximately 1 foot in 1,000 years (10 feet in 10,000 years), a landslide adjustment factor of 0.001 applies.
- If the lateral erosion of Buttermilk Creek is on the order of approximately 1 foot in 100 years (100 feet in 10,000 years), a landslide adjustment factor of 0.01 applies.
- If the lateral erosion of Buttermilk Creek is on the order of approximately 1 foot in 10 years (1,000 feet in 10,000 years), a landslide adjustment factor of 0.1 applies.

The QRA team assigned a 60% probability that the middle erosion conditions apply, and a 20% probability that each of the high and low erosion conditions apply. These probabilities were not derived from further consultations with the experts. They generally account for the experts' qualitative indications that the middle conditions correspond to their "best" estimates. However, relatively high probabilities are also assigned to the "high" and "low" conditions to account for the QRA team's lack of more informed guidance.

Uncertainty in Buttermilk Creek Lateral Erosion Adjustment Factor		
Buttermilk Creek Lateral Erosion Rate	Erosion Rate Probability	Frequency Adjustment Factor
1 foot in 1,000 years (Low)	0.20	1.0E-03
1 foot in 100 years (Middle)	0.60	1.0E-02
1 foot in 10 years (High)	0.20	1.0E-01

The overall frequency of "global" landslides at the SDA site is the product of the uncertainty distribution for the "random" landslide frequency, the adjustment factor for high water table conditions (0.15), and the uncertainty distribution for the Buttermilk Creek erosion adjustment factor.

SDA Site "Global" Landslide Frequency (event / year)				
5th Percentile	Median	Mean	95th Percentile	Error Factor
2.66E-11	7.28E-10	4.95E-09	2.01E-08	27

According to Section 6.3.2, the damage from these "global" landslides affects all of the SDA trenches.

6.3.4 References

- 6.3-1. "Landslides under Non-Seismic, Non-Gully Conditions within 30 Years", Wilson, M. P., and R. H. Fakundiny, Expert Elicitation Summary, SDA Trenches QRA, West Valley, New York, August 2008
- 6.3-2. "Stability Evaluations of Slopes Adjoining the New York State-Licensed Disposal Area (SDA) Western New York Nuclear Service Center (WNYNSC) West Valley, New York", Aloysius, D. L. and A. J. Nello, Document #SLK0215:SEA-178, 1992
- 6.3-3. "Geotechnical Analysis of Soil Samples from Test Trench at Western New York Nuclear Service Center, West Valley, New York", Fickies, R. H., R. H. Fakundiny, and E. T. Mosley, Document #NUREG/CR-0644 and also Document #NYSGS/79-2401, 1979
- 6.3-4. LaFleur glacial geology of the WNYNSC and vicinity, four quadrangle maps
- 6.3-5. "Scoby Hill Landslide Report", prepared by Geotechnical Engineering Bureau, Office of Technical Services, NYS Department of Transportation, NYSDOT, 2008
- 6.3-6. NYSERDA records:
- cross-sections of SDA within geologic context
 - test boring logs through the Lavery Till with blow counts
 - well construction diagrams
 - 18 years of water level records
- 6.3-7. Results from modified-Bishop slope-stability analyses for rotational landslides (Figure 6.3-1), Wampler, S. (QRA team), 2008

Table 6.3-1. Probability Assigned to Physical Condition Variations				
		GROUNDWATER LEVEL*		
		Low (65%)	Middle (25%)	High (10%)
SOIL STRENGTH PROPERTY*	Low (25%)	16.3%	6.3%	2.5%
	Nominal (65%)	42.3%	16.3%	6.5%
	High (10%)	6.5%	2.5%	1.0%

**values in parentheses are Wampler's estimates of probability of each condition occurring; therefore values in compartments are joint probabilities*

Table 6.3-2. Factors of Safety that a Failure Plane (Slip Circle) will Occur				
		GROUNDWATER LEVEL		
		Low	Middle	High
SOIL STRENGTH (COHESION)	Low	1.42	1.34	1.19
	Nominal	2.37	2.21	2.02
	High	3.70	3.74	3.28

Table 6.3-3. Probabilities that a Failure Plane (Slip Circle) will Occur (Including Uncertainties as Represented by Adjusted Factors of Safety)				
		GROUNDWATER LEVEL		
		Low	Middle	High
SOIL STRENGTH (COHESION)	Low	5%	11%	21%
	Nominal	0	0	0
	High	0	0	0

Table 6.3-4. Probability of Slope Failure at SDA within 30 Years (Table 6.3-1 Values Multiplied by Table 6.3-3 Values)				
		GROUNDWATER LEVEL		
		Low	Middle	High
SOIL STRENGTH (COHESION)	Low	0.8%	0.7%	0.5%
	Nominal	0	0	0
	High	0	0	0

Table 6.3-5. Probability of Trench Interception by Landslides within 30 Years (Assuming no Gully or Seismic Effects)				
		GROUNDWATER LEVEL		
		Low	Middle	High
SOIL STRENGTH (COHESION)	Low	0.08%	0.04%	0.05%
	Nominal	0	0	0
	High	0	0	0

Table 6.3-6. Slope Stability Computation Results for Non-Seismic Conditions					
Low Soil Strength (Probability = 0.25)					
North Slope					
Low Groundwater Level (Probability = 0.05)		Middle Groundwater Level (Probability = 0.9488)		High Groundwater Level (Probability = 0.0012)	
FS Value	Fraction	FS Value	Fraction	FS Value	Fraction
1.42	0.10	1.34	0.30	1.19	0.20
1.46	0.10	1.35	0.10	1.22	0.20
1.47	0.20	1.38	0.20	1.23	0.10
1.48	0.30	1.39	0.10	1.30	0.20
1.50	0.20	1.41	0.10	1.31	0.20
1.55	0.10	1.42	0.10	1.33	0.10
		1.44	0.10		
East Slope (North End)					
Low Groundwater Level (Probability = 0.05)		Middle Groundwater Level (Probability = 0.9488)		High Groundwater Level (Probability = 0.0012)	
FS Value	Fraction	FS Value	Fraction	FS Value	Fraction
1.27	0.10	1.08	0.10	1.03	0.10
1.32	0.10	1.10	0.10	1.12	0.10
1.42	0.10	1.22	0.20	1.17	0.10
1.45	0.10	1.26	0.10	1.18	0.20
1.48	0.10	1.29	0.10	1.19	0.10
1.51	0.10	1.38	0.10	1.24	0.10
1.64	0.10	1.49	0.10	1.28	0.20
1.74	0.10	1.60	0.10	1.29	0.10
1.89	0.10	1.64	0.10		
1.98	0.10				

Table 6.3-6. Slope Stability Computation Results for Non-Seismic Conditions					
Low Soil Strength (Probability = 0.25)					
East Slope (South End)					
Low Groundwater Level (Probability = 0.05)		Middle Groundwater Level (Probability = 0.9488)		High Groundwater Level (Probability = 0.0012)	
FS Value	Fraction	FS Value	Fraction	FS Value	Fraction
1.34	0.10	1.34	0.10	1.18	0.10
1.43	0.10	1.43	0.10	1.25	0.10
1.50	0.10	1.48	0.10	1.35	0.10
1.53	0.10	1.50	0.10	1.40	0.10
1.56	0.10	1.56	0.10	1.46	0.10
1.66	0.10	1.66	0.10	1.49	0.10
1.74	0.10	1.70	0.10	1.55	0.20
1.78	0.10	1.74	0.10	1.60	0.10
1.85	0.10	1.78	0.10	1.62	0.10
1.89	0.10	1.88	0.10		

Table 6.3-7. Adjusted Slope Failure Likelihoods within 30 Years					
Low Soil Strength (Probability = 0.25)					
North Slope					
Low Groundwater Level (Probability = 0.05)		Middle Groundwater Level (Probability = 0.9488)		High Groundwater Level (Probability = 0.0012)	
Failure Likelihood	Fraction	Failure Likelihood	Fraction	Failure Likelihood	Fraction
0.05	0.10	0.11	0.30	0.21	0.20
0.03	0.10	0.10	0.10	0.19	0.20
0.02	0.20	0.08	0.20	0.18	0.10
0.01	0.30	0.07	0.10	0.13	0.20
0.00	0.30	0.06	0.10	0.13	0.20
		0.05	0.10	0.11	0.10
		0.04	0.10		
East Slope (North End)					
Low Groundwater Level (Probability = 0.05)		Middle Groundwater Level (Probability = 0.9488)		High Groundwater Level (Probability = 0.0012)	
Failure Likelihood	Fraction	Failure Likelihood	Fraction	Failure Likelihood	Fraction
0.15	0.10	0.28	0.10	0.31	0.10
0.12	0.10	0.27	0.10	0.25	0.10
0.05	0.10	0.19	0.20	0.22	0.10
0.03	0.10	0.16	0.10	0.21	0.20
0.01	0.10	0.14	0.10	0.21	0.10
0.00	0.50	0.08	0.10	0.17	0.10
		0.01	0.10	0.15	0.20
		0.00	0.20	0.14	0.10

Table 6.3-7. Adjusted Slope Failure Likelihoods within 30 Years					
Low Soil Strength (Probability = 0.25)					
East Slope (South End)					
Low Groundwater Level (Probability = 0.05)		Middle Groundwater Level (Probability = 0.9488)		High Groundwater Level (Probability = 0.0012)	
Failure Likelihood	Fraction	Failure Likelihood	Fraction	Failure Likelihood	Fraction
0.11	0.10	0.11	0.10	0.21	0.10
0.05	0.10	0.05	0.10	0.17	0.10
0.00	0.80	0.01	0.10	0.10	0.10
		0.00	0.70	0.07	0.10
				0.03	0.10
				0.01	0.10
				0.00	0.40

Table 6.3-8. Failure Surface Trench Intersections, from Seismic Analyses					
Low Water Level		Middle Water Level		High Water Level	
Intersect Fraction	Probability	Intersect Fraction	Probability	Intersect Fraction	Probability
5.00E-03	0.037	2.00E-02	0.148	5.00E-03	0.032
2.00E-02	0.185	3.00E-02	0.111	2.00E-02	0.161
2.50E-02	0.037	3.50E-02	0.111	3.00E-02	0.161
3.00E-02	0.185	4.50E-02	0.037	4.00E-02	0.032
4.50E-02	0.075	5.00E-02	0.185	5.00E-02	0.032
5.00E-02	0.037	6.50E-02	0.075	5.50E-02	0.130
6.00E-02	0.111	8.00E-02	0.296	6.00E-02	0.065
6.50E-02	0.111	1.30E-01	0.037	6.50E-02	0.032
9.00E-02	0.185			7.00E-02	0.065
1.50E-01	0.037			7.50E-02	0.161
				8.50E-02	0.097
				1.25E-01	0.032
5.17E-02	Mean	5.45E-02	Mean	5.31E-02	Mean

Table 6.3-9. Updated Failure Surface Trench Intersections					
Low Water Level (Expert Estimate = 0.10)		Middle Water Level (Expert Estimate = 0.05)		High Water Level (Expert Estimate = 0.10)	
Intersect Fraction	Probability	Intersect Fraction	Probability	Intersect Fraction	Probability
5.00E-03	0.007	2.00E-02	0.122	5.00E-03	0.005
2.00E-02	0.113	3.00E-02	0.112	2.00E-02	0.094
2.50E-02	0.027	3.50E-02	0.118	3.00E-02	0.127
3.00E-02	0.154	4.50E-02	0.042	4.00E-02	0.030
4.50E-02	0.080	5.00E-02	0.209	5.00E-02	0.034
5.00E-02	0.042	6.50E-02	0.082	5.50E-02	0.146
6.00E-02	0.137	8.00E-02	0.294	6.00E-02	0.076
6.50E-02	0.141	1.30E-01	0.022	6.50E-02	0.039
9.00E-02	0.253			7.00E-02	0.080
1.50E-01	0.046			7.50E-02	0.202
				8.50E-02	0.125
				1.25E-01	0.041
6.04E-02	Mean	5.39E-02	Mean	6.03E-02	Mean

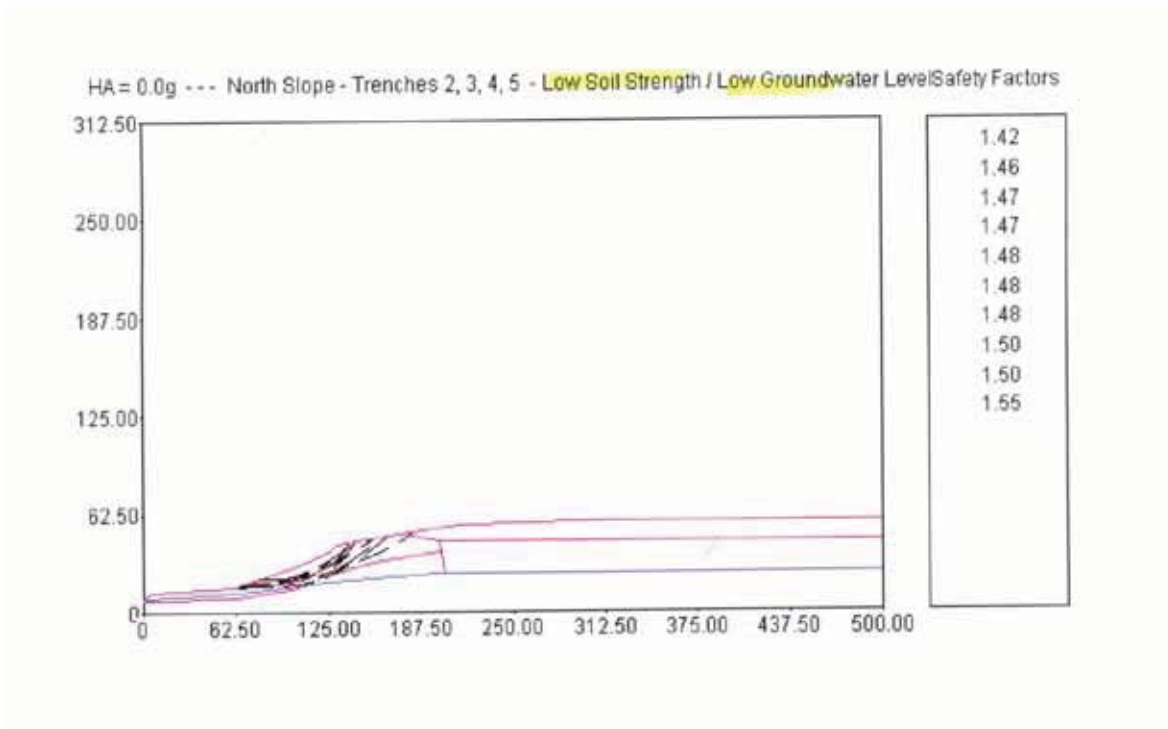
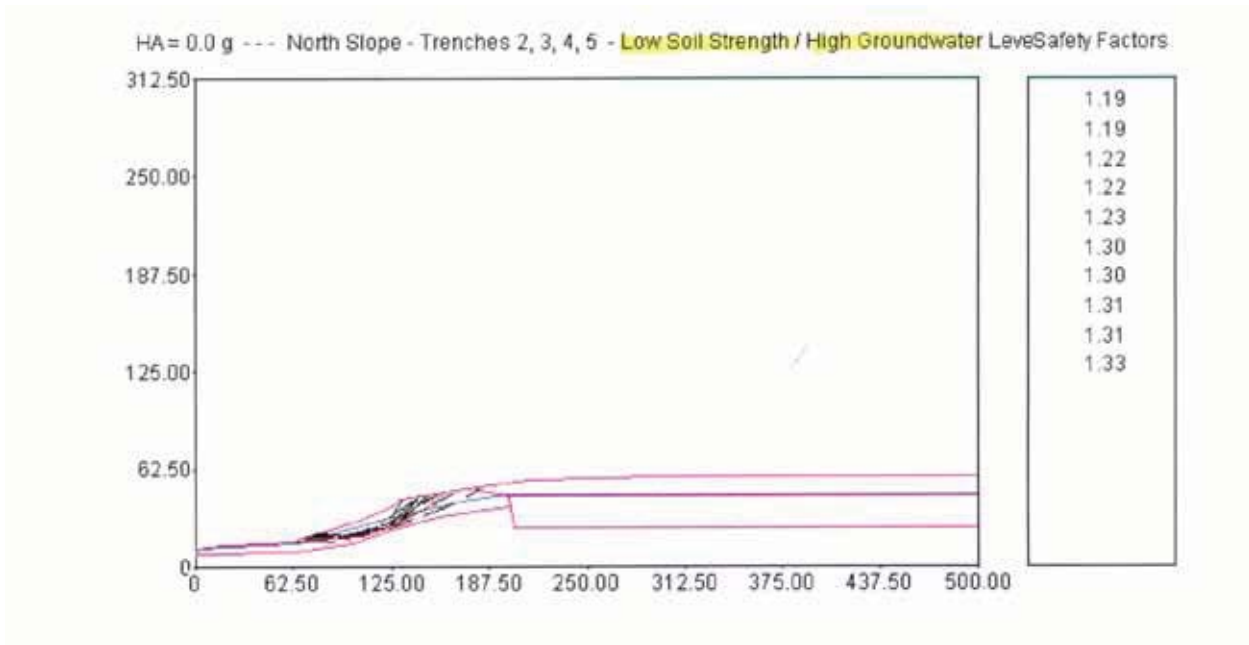

Figure 6.3-1. Example Results from Modified-Bishop Slope Stability Analyses for Rotational Landslides

6.4 TRENCH CAP AND SLOPE GULLY EROSION

The analyses described in this section were performed by Dr. Sean J. Bennett and were submitted to the QRA team as part of the expert elicitation inputs for the study. Except for editorial formatting, the material in Sections 6.4.1 through 6.4.3 is reproduced verbatim from Dr. Bennett's report (Reference 6.4-1). Section 6.4.4 summarizes the QRA team's interpretation of these analyses and explains how the results are applied in the risk assessment models.

6.4.1 Introduction

At the direct request of NYSERDA, an assessment of rill and gully erosion processes was undertaken at the State-licensed Disposal Area, West Valley Demonstration Project, New York.

Three erosion scenarios are considered: (1) with the cover removed, the erosion of the trench cap via a gully headcut; (2) with the cover removed, the erosion of the trench cap via rill development and incision; and (3) with the cover intact, the development of actively migrating gullies from the surrounding areas of the SDA and their intersection with the SDA boundaries. The only trigger mechanism considered here is a 24-hr rainfall event, ranging in intensity from 2 to 30 in, and ranging in duration from 2 to 10 hr. The analytic basis for each erosion process is described in detail, failure scenarios are presented, conditional probabilities are assigned, and "High", "Best", and "Low" estimates to these processes are established.

The following disclaimers are applied: (1) this exercise was accomplished within a short time frame (ca. 1-week) using available data, and is not intended to be an exhaustive study; (2) the rill and gully erosion processes represented here could be addressed by other analytic techniques; (3) assumptions, approximations, and simplifications were invoked for lack of data and brevity of time; and (4) a mix of SI and English units are used throughout. Moreover, subsurface hydrologic processes (seepage erosion), consecutive days of rain, and other trigger and trench release mechanisms affected by the presence of gullies are not considered.

6.4.2 Rill and Gully Erosion on the SDA with the Cover Removed

It is envisioned that erosion on the SDA with the cover removed can occur as (1) a gully headcut migrating through the clay cap parallel to the trenches (flow occurs on top of and along a trench) or (2) a rill incising through the clay cap perpendicular to the trenches (flow occurs on perpendicular to the trenches). Each case is described and quantified below.

6.4.2.1 Gully Headcut Erosion Parallel to Trench

Overland flow running parallel to a trench and then descending at the downstream end or the side of the clay cap is analogous to flow over an earthen embankment with a height H (m; Figure 6.4-1). The overfall face of the embankment is susceptible to erosion, based on flow and material characteristics. As such, this embankment will migrate upstream at a rate of dx/dt (where x is upstream distance and t is time) when the erosional forces along the embankment face exceed the material's critical conditions and expose the buried wastes to the atmosphere. To determine this environmental condition for exposure due to embankment erosion and migration, the flow rate over the cap and the erosivity of this flow must be calculated and the erodibility of the material must be defined.

Analytic Description

Surface hydrology on the cap can be approximated using the SCS Curve Number approach, as detailed in Reference 6.4-2. The effective rainfall rate W_{eff} is determined from

$$W_{eff} = \frac{(W - 0.2V_{max})^2}{W + 0.8V_{max}} \quad (6.4.1)$$

where W is total rainfall (in), V_{max} is the maximum retention capacity defined as

$$V_{max} = \frac{1000}{CN} - 10 \quad (6.4.2)$$

and CN is the curve number. For dirt-covered roads and for hydrologic group D (high overland flow potential), which approximates the cap material, $CN = 89$ (Reference 6.4-3). Assuming a triangular hydrograph, time to rise T_R is defined as

$$T_R = 0.5T_W + 0.6T_C \quad (6.4.3)$$

where T_W is the duration of excess rainfall, and T_C is watershed time of concentration. Here, T_W is assumed to be equal to the duration of the storm and T_C (min) is defined as

$$T_C = 0.23 \frac{K^{0.41} n^{0.75} L^{0.58}}{c^{0.5} W_{eff}^{0.25} S^{0.375}} \quad (6.4.4)$$

where $K = L/A^{0.6}$ (ft), L is the length of the longest drainage path (ft), A is drainage area (ft²), n is Manning's roughness coefficient (assumed to be 0.01; ft^{0.33}-s), c is a channel shape factor (assumed to be 0.1; dimensionless), and S is slope (dimensionless; Reference 6.4-4). Peak discharge q_{pk} (ft³/s) is then determined from

$$q_{pk} = \frac{484W_{eff}A}{T_R} \quad (6.4.5)$$

where A is in units of mi² and T_R is in units of hr.

Unsteady flows are not considered here. Instead it is assumed that q_{pk} will consist of a steady flow with a duration of one-half the length of the storm ($0.5I$ where I is the duration of the storm event (s)), which conserves total mass flux. Unit discharge q is defined as

$$q = \frac{q_{pk}}{w} \quad (6.4.6)$$

where w is flow width (m).

Temple and Moore (Reference 6.4-5) proposed an energy-based model to describe the erosive attack along the face of the sloping embankment and the rate of headcut advance. The rate of headcut advance dx/dt (m/h) can be determined by

$$\frac{dx}{dt} = C \left[(q\gamma H)^{0.333} - E_T^{0.333} \right] \quad (6.4.7)$$

where C is a material dependent advance rate coefficient ($h^{-2/3}$), γ is unit weight of water (N), and E_T is the energy dissipation rate (power) threshold associated with headcut erosion causing upstream advance ($m^2 \cdot N \cdot m/s$). The material dependent advance rate coefficient C is defined as

$$C = -0.0369 \ln(K_h) + 0.142 \quad (6.4.8)$$

where K_h is the headcut erodibility index, which depends upon the geotechnical characteristics of the material. Temple and Moore (Reference 6.4-5) note that for alluvium and fill material, $K_h = 0.05 - 0.07$. The threshold energy dissipation rate E_T along the headcut face is defined as

$$E_T = 52500 K_h^{0.5} \exp[-3.23/\ln(101K_h)] \quad (6.4.9)$$

To determine the erosion of the trench by runoff and downward flow along the trench face (gully headcut advance), the average area A and slope S of the top of the trench is calculated, peak q_{pk} and unit discharge q are determined for a specific rainfall rate W and duration, with consideration for the material and landscape characteristics, and a headcut erosion rate dx/dt is predicted. Failure of the trench is considered to occur when the trench face begins to migrate due to the flow. That is, the wastes are not exposed as long as the cap embankment under attack does not migrate.

Conditional Probabilities

Conditional probabilities are assigned as follows. There are 13 trenches (1&2, 3 to 14), all of which are considered separately. The conditional probability for the failure of each trench pT is the same ($pT_i = 0.076$ where i is a given trench). Thus, $pT = \sum_{i=1}^{13} pT_i = 1.0$. Five different storm durations are applied (2, 4, 6, 8, and 10 hr) for a given 24-hr time period event. Each storm duration is given the same conditional probability pS ($pS_j = 0.2$ where j is a given storm duration). Thus, $pS = \sum_{j=1}^5 pS_j = 1.0$. Rainfall rates of 2 to 30 in (1-in increments) within a 24-hr time period are considered, and the probabilities for these events are determined elsewhere. Three erodibility conditions are considered: $K_h = 0.03, 0.05, 0.07$, which are the "High," "Best," and "Low" estimates. As noted above, exposure of the buried waste occurs when the embankment under hydraulic attack begins to migrate. Thus, the conditional probability for exposure of the buried waste at the SDA in a particular trench for a given rainfall rate and storm duration is $pT_i \times pS_j = 0.0152$, noting that the cover is removed.

The characteristics of the trenches are summarized in Table 6.4-1 (derived from Reference 6.4-6). It is noted that the width of each trench is commonly 35 ft, except for Trenches 6 and 7. It is assumed here that approximately 25 ft of the cap material is available for runoff generation (i.e., each segment of the cap covering a trench has a 5-ft side-slope at 18° and that the intervening areas between the trenches are also covered by cap material). The average slope along (parallel to) the length of the each capped trench is also provided. The thickness of the cap is assumed to be 9 ft. These values are used in the determination of runoff and gully headcut migration.

Results and Discussion

Figure 6.4-2 displays the fragility curves derived for the migration of headcut gullies along the length of the trenches. Numerical values for these curves are tabulated in Table 6.4-2. The conditional probabilities for all storm durations and all trench breaches are summed for a given 24-hr rainfall event. For the "Best Estimate" ($K_h = 0.05$), the cap covering the waste at the SDA is breached by a migrating headcut gully for any rainfall intensity greater than 18-in in a 24-hr period. For the "High Estimate" ($K_h = 0.03$), the cap is breached by a migrating headcut gully for any rainfall intensity greater than 6-in in a 24-hr period. No erosion is predicted for any storm up to 30-in in 24-hr of any duration for the "Low Estimate" ($K_h = 0.07$).

Using this analytic approach, gully headcut advance is more likely to occur under high runoff rates q_{pk} and unit discharges q . No single trench is more susceptible to gully headcut erosion because most trenches have nearly identical physical characteristics. Trenches 1&2, 3, and 4 have slightly higher risk of erosion due to their larger surface areas, whereas no such failures are observed for Trenches 6 and 7 due to their relatively small areas (Table 6.4-1). Improvement to this analytic approach would include more accurate representation of the trench areas and slopes and in situ determination of K_h .

6.4.2.2 Rill Erosion Perpendicular to Trench

There currently are no soil erosion models available that can predict the occurrence and incision of a rill into a hillslope. Such a model is herein derived, and its conceptual framework is as follows. Overland flow along a given trench can flow perpendicular to the trench axis, along a slope that is much greater than the cap slope parallel to the trench. The total overland flow occurring on the top of the trench cap is split in two, with each half being released to the two side-slopes of the trench (as shown in Figure 6.4-3). Rills can form due to this flow concentration. The width and initial depth of this concentrated flow is approximated based on the flow rate, rill density, and dimensional considerations. As the steady flow continues during the storm event, bed incision into the cap ensues, and a threshold erosion depth can be specified that corresponds to a trench failure and exposure of the wastes to the atmosphere. Instead of deriving rill erosion rates for each trench and for each slope, ensemble values will be used. Details of this analytic procedure are as follows.

Analytic Framework

The values for q_{pk} already have been derived for each trench and for each 24-hr rainfall using the SCS Curve Number approach (see above). Here, an average peak discharge \bar{q}_{pk} for all

trenches for each 24-hr rainfall is derived, as well as the average trench length $\bar{L} = 523.7$ ft (159.6 m) and total trench width is used (all 25-ft widths were changed to 35-ft widths in Table 6.4-1, with the exceptions of Trenches 6 and 7). It is assumed that rill density is approximately 1.0 rills per meter, and that flow rates are the same in each rill (Reference 6.4-7). As such, the rill scaling parameter is $1/\bar{L} = 0.0063$ using meters (i.e., 1 rill occurs every 1 m of trench length). The flow rate per rill q_R (m³/s) is defined as

$$q_R = 0.5 \cdot 0.0063 \cdot \bar{q}_{pk} = 0.00315 \bar{q}_{pk} \quad (6.4.10)$$

The width of an individual rill w_R is defined using (Reference 6.4-8)

$$w_R = 2.51 q_R^{0.412} \quad (6.4.11)$$

As the width-to-depth ratio for rills and gullies is commonly 2 to 6, it is assumed that the initial depth of a rill $d_R = w_R/4$ (m; Reference 6.4-9). This enables the calculation of a boundary shear stress τ (Pa) acting on the trench side-slope using

$$\tau = \rho g R S_R \quad (6.4.12)$$

where ρ is fluid density (kg/m³), g is gravitational acceleration (m/s²), R is hydraulic radius (m; $R = w_R d_R / (2d_R + w_R)$) and S_R (dimensionless) is the slope of the rill acting perpendicular to the trench cap. There are 13 trenches and two side slopes (26 side-slopes in total). Based on 1-ft contour maps created by Dames and Moore (1995; as provided by NYSERDA), S_R for each trench and for each side-slope can be approximated. For this analysis, these side-slopes are aggregated as follows: 14 side-slopes (54%) are ~ 0.07 , 11 side-slopes (42%) are ~ 0.14 , and 1 side-slope (4%) is ~ 0.21 (this side-slope is the northeastern side of Trench 1&2).

The rate of soil erosion within a rill is typically assumed to be proportional to the excess shear stress conditioned by the erodibility of the material (Reference 6.4-10). Thus, once boundary shear stress τ (Pa) exceeds the critical shear stress for the soil τ_c (Pa), soil erosion ensues. The rate of erosion for rills D_c (kg/m²-s), assuming supplied-limited conditions, is defined as

$$D_c = k_d (\tau - \tau_c) \quad (6.4.13)$$

where k_d (s/m) is the soil's erodibility coefficient. From Appendix F of the Draft Environmental Impact Statement (Table F-10), $k_d \approx 0.002$ s/m and $\tau_c \approx 3.29$ Pa for soil materials on the SDA are reported. In comparison to the extensive data compiled by Knapen, et al. (Reference 6.4-11), for a soil with $\tau_c = 3.29$ Pa, $k_d \approx 0.01$ s/m with very few observations lower than this value. For the purposes here, it is assumed that $\tau_c = 3.29$ Pa and k_d will vary from 0.002 s/m ("Low Estimate"), 0.01 s/m ("Best Estimate"), and 0.02 s/m ("High Estimate"; see below).

It is further assumed here that during the erosion process, the rill with a constant width and an initial depth incises into the cap material perpendicular to the rill slope. That is, soil erosion can cause both downward incision and upstream migration of the rill. The flow is considered steady with a duration of one-half the length of the storm (0.5 I). Thus, the total depth of rill incision D_R (m) for a given flow event for a given rill slope assuming supply-limited conditions is defined as

$$D_R = \frac{k_d(\tau - \tau_c) \cdot 0.5I}{\delta} \quad (6.4.14)$$

where δ (kg/m³) is the bulk density of the soil, taken here as 1,700 kg/m³ (Reference 6.4-12). Failure of the trench is considered to occur when a rill erodes to a critical depth. Since the rill is considered to be actively eroding perpendicular to the side-slope, a critical incision distance of 1 m is used.

Conditional Probabilities

Conditional probabilities are assigned as follows. There are 13 trenches (1&2, 3 to 14) with two side-slopes having one of three slope values (0.07, 0.014, or 0.21). The conditional probability for the failure of each side-slope pSS is as follows (based on their frequency of occurrence):

$pSS_{0.07} = 0.54$, $pSS_{0.14} = 0.42$, and $pSS_{0.21} = 0.04$. Thus, $pSS = \sum_{k=1}^3 pSS_k = 1.0$, where k is a

given side-slope value. Five different storm durations are applied (2, 4, 6, 8, and 10 hr) for a given 24-hr time period event. Each storm duration is given the same conditional probability pS

($pS_j = 0.2$ where j is a given storm duration). Thus, $pS = \sum_{j=1}^5 pS_j = 1.0$. Rainfall rates of 2 to

30 in (1-in increments) within a 24-hr time period are considered, and the probabilities for these events are determined elsewhere. Three erodibility coefficients are considered: $k_d = 0.002, 0.01, 0.02$ s/m, which are the "High," "Best," and "Low" estimates. As noted above, exposure of the buried waste occurs when a rill incises 1 m into the side-slope. Thus, the conditional probability for exposure of the buried waste at the SDA along a particular trench side-slope for a given rainfall rate and storm duration due to rill erosion is equal to $pSS_k \times pS_j$, noting that the cover is removed.

Results and Discussion

Figure 6.4-4 displays the fragility curves derived for the incision of rills along the side-slopes of the trenches. Numerical values for these curves are tabulated in Table 6.4-3. The conditional probabilities for all storm durations and all trench breaches are summed for a given 24-hr rainfall event. For the "Best Estimate" ($k_d = 0.01$ s/m), the cap covering the waste at the SDA is breached by an incised rill at least 1-m deep for any rainfall intensity greater than 19-in in a 24-hr period. For the "High Estimate" ($k_d = 0.02$ s/m), the cap is breached by an incised rill at least 1-m deep for any rainfall intensity greater than 3-in in a 24-hr period, but more notably for any rainfall greater than 7-in. No significant rill erosion is predicted for any storm up to 30-in in 24-hr of any duration for the "Low Estimate" ($k_d = 0.002$ s/m).

As rill width and depth both are a function of flow rate q_R , the largest rills will occur where these rates are at their highest. Predicted rills tend to be 0.02 to 0.13 m wide and initially 0.01 to 0.03 m deep. Shear stress τ increases with both flow depth (flow rate) and rill slope, thus predicted values of τ range from 2 to 15 Pa for $S = 0.07$ and 6 to 45 Pa for $S = 0.21$. Thus, those trenches with higher side-slopes and greater surface areas are most vulnerable to rill erosion, with the northeastern side of Trench 1&2 being the most vulnerable. Improvements to this

analytic approach would include more accurate representation of trench areas and side-slopes, a quantitative rill-incision failure criterion, and in situ determination of τ_c and k_d .

6.4.3 Gully Erosion on the Slopes Adjacent to the SDA

There exists the potential for actively eroding gullies to form within individual storm events and for these gullies to migrate from their point of initiation toward the SDA. Here a model framework previously developed for ephemeral gullies on agricultural fields is modified and applied (Reference 6.4-13, which relies heavily upon the headcut erosion model of Reference 6.4-14). It should be noted that many assumptions were required to use the analytic expressions below.

For a given runoff event, a peak discharge due to overland flow can be constructed at the mouth or outlet of a small field, and this flow rate is a function of upstream drainage area. At this point, it is assumed that the flow rate exceeds the erosion threshold of the soil, and landscape incision is initiated in the form of a headcut, which is a step-change in bed surface topography where intense, localized erosion takes place (Figure 6.4-5, Reference 6.4-15). This headcut will first incise down to an equilibrium scour depth and migrate upstream, at a magnitude and rate that are proportional to the overland flow rate and modulated by local boundary conditions. During upstream migration, the flow rate at the headcut decreases because the upstream drainage area decreases. The following assumptions are made: (1) instantaneous flow conditions are steady and uniform; (2) the boundary conditions of the landscape are spatially invariant; and (3) flow rates depend on the upstream drainage area (flow rate is spatially varied). The specific gully initiation locations and details of the analytic procedure as are follows.

6.4.3.1 Potential Locations for Gully Initiation

An examination of high-resolution topographic maps of the SDA provides the basis for postulating the potential locations for gully initiation and erosion. The following criteria were used to delineate these locations: (1) the gully heads on the landscape need to be arcuate in shape with its convexity pointing toward the SDA; and (2) an approximate drainage area for the initiation point must be defined and unaffected by the infrastructure of the SDA.

Using these criteria, eight gully-initiation locations are identified. Figure 6.4-6 shows six locations (G1 to G6) along the eastern side of the SDA and their approximate drainage areas. In these locations, it is assumed that the inflection point of the landscape is the trigger for gully initiation. Figure 6.4-7 shows two locations (G7 and G8) along the northern end of the SDA and their approximate drainage areas. In these locations, it is assumed that Erdmann Brook is the trigger for gully initiation. A summary of pertinent data for these locations is provided in Table 6.4-4.

6.4.3.2 Analytic Framework

Surface hydrology within each gully drainage area can be approximated using the SCS Curve Number approach. Equations to predict W_{eff} (6.4.1), V_{max} (6.4.2), T_R (6.4.3), and T_C (6.4.4), and q_{pk} (6.4.5) are defined above. The areas surrounding the SDA are considered meadows with

high overland flow potential, thus $CN = 78$ (Reference 6.4-3). It is assumed that q_{pk} will consist of a quasi-steady flow (see below) with a duration of one-half the length of the storm (0.5I).

For this given flow rate, the width of the gully w_G (m) is defined using equation (6.4.11) and the derived q_{pk} (m^3/s), and a similar gully width-to-depth ratio is assumed ($w_G/d_G = 4$). Gully unit discharge q_G (m^2/s) is then defined as

$$q_G = q_{pk} / w_G \quad (6.4.15)$$

The flow near and within the headcut scour hole, the depth of scour, and the rate of headcut migration can be approximated using the analytic equations of Alonso, et al. (Reference 6.4-14), with some significant simplifications. At the brinkpoint and within the scour pool domain, the following approximations are made: (1) flow near the headcut is assumed to be critical, such that $Fr = 1$, where $Fr = u_b / \sqrt{gd_b}$ and u_b (m/s) and d_b (m/s) are the mean flow velocity and depth at the headcut brinkpoint; (2) the jet entry angle is assumed to be 60° , which is typical for a free overfall at these bed slopes; and (3) the vertical distance from brink to tailwater surface h is 0.03 m, meaning that the overfall is aerated and the plunge pool is nearly filled with water.

The equilibrium scour depth S_D (m) for an actively migrating headcut in homogenous soil materials is defined as

$$S_D = \sigma V_e q_G^{0.8} \sin \theta + h \quad (6.4.16)$$

$$\sigma = \frac{5\rho v^{0.2}}{32\tau_c} \quad (6.4.17)$$

$$V_e = \frac{q_G}{d_b \cos \theta} \quad (6.4.18)$$

where V_e is the jet entry velocity and v is the kinematic viscosity of the fluid (m^2/s). The rate of headcut migration M (m/s) is defined as

$$M = V_e \sqrt{\frac{\mu q_G}{S_D - h}} \quad (6.4.19)$$

$$\mu = \frac{1}{2} \rho k_d \sin^2 \frac{\theta}{2} \quad (6.4.20)$$

In its original derivation, Alonso, et al. (Reference 6.4-14), employed the empirical relationship of Hanson and Simon (Reference 6.4-16) to define the erodibility of the soil, given as

$$k_d = 0.2\tau_c^{-0.5} \quad (6.4.21)$$

where k_d is in units $\text{cm}^3/\text{N}\cdot\text{s}$ and τ_c is in units Pa. With $\tau_c = 3.29$ Pa as previously noted for the SDA, $k_d = 1.1\text{e} - 07$ $\text{m}^3/\text{N}\cdot\text{s}$ using equation (6.4.21). Thus the total distance D_T (m) an actively migrating headcut traverses during a single runoff event and boundary conditions is defined as

$$D_T = M \cdot 0.5I \quad (6.4.22)$$

As the headcut migrates upstream, the contributing drainage area decreases, so the discharge at the head of the gully also decreases. As such, all flow-dependent gully erosion parameters are spatially-varied. To address this spatial variation, a maximum gully length L_{\max} (m) for a given drainage area A (ha) can be defined based on Leopold, et al. (Reference 6.4-17)

$$L_{\max} = 80.3A^{0.6} \quad (6.4.23)$$

The reduction of upstream drainage area A_j as a function of gully length proportion of the drainage area is defined as

$$A_j = A \left(1 - \left[L_j / L_{\max} \right]^{.67} \right) \quad (6.4.24)$$

where j represents the upstream location of the migrating gully within a given flow event for a given timestep (Reference 6.4-13). Here, L_{\max} is equal to the down-valley length of drainage area as listed in Table 6.4-4, and each runoff event is divided into five equal timesteps Δt ($t = (0.5I)/5$, s) where all flow-dependent gully parameters are reassessed. Thus, after each timestep, the location of the headcut is determined, its upstream contributing area and peak discharge are recalculated, all gully erosion parameters are reassessed, and the next timestep is entered. The gully process ceases when either L_{\max} is reached during a runoff event or the runoff event reaches its conclusion.

6.4.3.3 Conditional Probabilities

Conditional probabilities are assigned as follows. There are eight potential gully locations (G1 to G8). The conditional probability for each gully pG to cause failure of the SDA (defined below) is the same, given as $pG_l = 0.125$ where l refers to a specific gully. Thus,

$pG = \sum_{l=1}^8 pG_l = 1.0$. Five different storm durations pS are applied (2, 4, 6, 8, and 10 hr) for a given 24-hr time period event. Each storm duration is given the same conditional probability pS ($pS_j = 0.2$ where j is a given storm duration). Thus, $pS = \sum_{j=1}^5 pS_j = 1.0$. Rainfall rates of 2 to

30 in (1-in increments) within a 24-hr time period are considered, and the probabilities for these events are determined elsewhere. Three erodibility coefficients are considered: $k_d = 1.1\text{e} - 7$, $5.5\text{e} - 8$, and $1.1\text{e} - 8$ $\text{m}^3/\text{N}\cdot\text{s}$, which are the "High," "Best," and "Low" estimates based on Hanson and Simon (Reference 6.4-16).

Failure of the SDA occurs when the distance traversed by the migrating headcut during a single storm event equals the down-valley length of the drainage area L_{\max} , as listed in Table 6.4-4. That is, site failure due to gully erosion is deemed to occur when an offsite migrating gully head

intersects the SDA boundary during a 24-hr runoff event (see Figures 6.4-6 and 6.4-7). While an offsite migrating gully could not penetrate the current infrastructure of the SDA, a gully intersecting the SDA boundary could very well adversely affect the structural and environmental integrity of the buried wastes. Thus, the conditional probability for failure of the SDA for a given rainfall rate and storm duration due to an approaching or intersecting gully is $pG_l \times pS_j = 0.025$.

6.4.3.4 Results

Figure 6.4-8 displays the fragility curves derived for actively migrating gullies from the surrounding areas of the SDA to intersect the SDA boundaries. Numerical values for these curves are tabulated in Table 6.4-5. The conditional probabilities for all storm durations and for all gullies are summed for a given 24-hr rainfall event. For the "Best Estimate" ($k_d = 5.5e - 8 \text{ m}^3/\text{N-s}$), the boundary of the SDA is vulnerable to gully encroachment when 24-hr rainfall rates exceed 4-in, and this risk increases monotonically with rainfall rate. For the "High Estimate" ($k_d = 1.1e - 7 \text{ m}^3/\text{N-s}$), there is significant risk that migrating gully headcuts will intersect the SDA boundary. For the "Low Estimate" ($k_d = 1.1e - 8 \text{ m}^3/\text{N-s}$), no such risk exists for any rainfall event.

In general, gullies increase in dimension as unit discharge q_G increases, but extension across the landscape increases more so with flow duration rather than flow rate. This is because headcut migration rate M is weakly dependent on unit discharge q_G . Thus, longer-duration storms increase the distance of migration. Predicted gullies range from 0.1 to 1 m wide and 0.03 to 0.25 m deep, with scour holes 0.06 to 0.25 m deep that migrate at rates of 0.0003 to 0.004 m/s. The SDA appears most vulnerable to gully encroachment on its southeastern side where gullies G4, G5, and G6 are postulated to occur and where the length to the SDA boundary is at its shortest. Gullies G7 and G8 pose the least risk to the SDA because these gullies have the greatest distances for the migrating headcuts to traverse. Improvements to this analytic approach would include more accurate representation of the gully hydraulics, drainage areas, failure criteria, and in situ determination of τ_c and k_d .

6.4.4 Application of the Analyses

The following sections summarize the QRA team's interpretations of the trench cap and gully erosion analyses, and explain how the results are applied in the SDA risk assessment models.

6.4.4.1 Trench Cap Erosion

The analyses in Section 6.4.2 quantify the likelihood that surface water flows and runoff will erode the trench caps to a depth that is sufficient to expose the top surface of the buried waste material. It is assumed that the trenches will also fill with water during these scenarios.

This damage can occur only during conditions when the geomembrane covers are not intact, and the SDA surface is exposed.

6.4.4.2 Slope Gully Erosion

The analyses in Section 6.4.3 quantify the likelihood that gullies in the adjacent slopes will erode to the extent that the gully headcuts intersect the SDA boundary, which is nominally denoted by the site fence line. In particular, the fragility results summarized in Table 6.4-5 and Figure 6.4-8 apply to conditions when the distance traversed by the gully headcut (L_{max}) is equal to the distance between the original gully head and the SDA fence. The SDA site boundary distance was used for L_{max} in these analyses, due to concerns that gully intrusion into the site area could disrupt the stormwater drainage systems and the peripheral anchors for the geomembranes. Therefore, this damage may contribute to conditions that functionally disable portions of the engineered drainage systems and the geomembrane covers, requiring subsequent repairs or replacement.

Damage to Geomembranes

The analyses in Section 6.4.3 were performed for 24-hour precipitation events. Five nominal storm durations (2, 4, 6, 8, and 10 hours) were used to derive rainfall intensities during these events. Section 5.2 summarizes the historical precipitation data for the region surrounding the West Valley site. Precipitation exceedance frequencies are derived for 24-hour, 48-hour, 3-day, 7-day, and 14-day exposure periods.

The historical experience shows that the largest multi-day cumulative precipitation totals almost always involve severe single-day storms. In other words, the largest 3-day, 7-day, and 14-day cumulative precipitation periods typically include a severe 1-day storm, preceded or followed by days with much lower accumulations. Thus, intense precipitation events that may cause extensive gully migration are determined almost entirely by single-day storms. Periods of moderate to strong precipitation that continue for several consecutive days are not evident in the regional weather records. (Multi-day snowstorms do occur in the region. Although these storms may result in significant snow accumulations, they do not contribute directly to rapid gully erosion.)

Reviews of the historical data and examinations of the precipitation exceedance frequencies indicate that 48-hour storm periods may also contribute to significant gully erosion. The precipitation totals for some 48-hour periods include significant contributions from consecutive days, indicating that longer duration storms may persist for several hours, or short duration storms may span the daily reporting intervals. To account for these storms, it was assumed that the fragility results in Table 6.4-5 and Figure 6.4-8 apply to both 24-hour and 48-hour precipitation periods. This assumption introduces some amount of numerical conservatism, because it is likely that some of the 48-hour precipitation totals result from less intense storms. However, it was not practical to refine the historical data analyses or the exceedance frequencies to more precisely account for individual storms. The data and the exceedance analyses confirm that the largest precipitation totals for 3-day, 7-day, and 14-day exposure periods are determined entirely by 24-hour or 48-hour storms. Therefore, extension of the gully erosion analyses beyond a 48-hour period is not warranted.

A probabilistic weight of 75% was assigned that the "best estimate" parametric conditions in the fragility analyses may apply to actual conditions at the SDA site during the 30-year period of this study. Equal weights of 12.5% each were assigned that the "high" and "low" estimates may apply.

The 24-hour and 48-hour precipitation exceedance frequencies from Section 5.2 were convolved with the weighted slope gully fragility results from Figure 6.4-8 to derive the frequency at which gully erosion will impact the SDA site and cause possible damage to the geomembranes. The following table summarizes the results from that calculation.

Frequency of Slope Gully Intrusion that Damages the Geomembranes, 24-Hour and 48-Hour Precipitation Events, Gully Intrusion into the SDA Fenced Area (event / year)				
5th Percentile	Median	Mean	95th Percentile	Error Factor
2.21E-03	8.25E-03	1.64E-02	5.22E-02	4.9

Approximately 67% of this damage is caused by precipitation totals in the 2-inch to 4-inch range. Of this total, approximately 13% is due to 1-day storms, and approximately 54% is due to 2-day storms.

Gully Intersection with Trenches

The gully migration distances (L_{max}) for the analyses in Section 6.4.3 are shown by the "Down-Valley Length of Drainage Area" entries in Table 6.4-4. Comparison of these distances with the "Length to Nearest Trench" entries shows that the analyses in Section 6.4.3 were terminated when the gully headcuts were still at some distance from the waste trenches. The closest approach distance is for Gully 1, where the analyses terminate with the gully head approximately 22 feet from the east side of Trenches 1/2. Thus, the results in Table 6.4-5 and Figure 6.4-8 do not apply to erosion damage that directly intersects any of the waste trenches.

Discussions with the expert indicated that it is effectively not possible for the gullies to migrate much further than the SDA fence if the geomembranes are intact and the drainage control systems are functioning. The QRA team assumed that gully intrusion beyond the fence line will cause damage that may require repairs or replacement of the geomembranes, as discussed in the preceding section. In addition to those repairs, NYSERDA has also indicated that mitigation measures would be implemented to reinforce the slopes and prevent further progression of the gully heads. Those measures and estimates of their implementation times are described in Section 7.1.

The SDA risk assessment models evaluate conditions that may damage the geomembrane covers and require extensive repairs or replacement. Gully erosion within the site fence line is one of those conditions. Section 7.2 describes the analyses of several others. It is possible that very severe precipitation events may occur during periods when the geomembranes are removed. These events may cause sufficient gully erosion for headcuts to migrate well within the SDA area and directly intersect the waste trenches. To quantify the likelihood of these conditions, the QRA team performed supplemental fragility analyses, using the same models that were developed for the analyses in Section 6.4.3. The QRA team's analyses assumed that all site hydrologic parameters are the same as those evaluated in Section 6.4.3. The only differences are that the geomembranes were removed, and the migration distance for each gully (L_{max}) was set equal to the "Length to Nearest Trench" distance from Table 6.4-4. This

process effectively retains the same gully migration rates over the additional distance between the site fence and the trenches.

The results from these analyses are summarized in Table 6.4-6 and Figure 6.4-9. Gully intersection with the waste trenches occurs only for the "high estimate" parametric conditions and only for precipitation totals above approximately 16 inches in 24 hours. The analyses show that Gully 1 is the predominant contributor to this damage. There is a very small likelihood that Gully 2 may also intersect the trenches, but only when precipitation totals approach approximately 30 inches. The direct damage from these gully intrusions affects only Trenches 1/2.

The functional impacts from these gully erosion conditions are evaluated as follows in the SDA risk assessment models.

- It is likely that the gully erosion will destabilize other sections of the East slope, causing localized collapse or landslides. This damage is assumed to intersect Trench 8, in addition to the direct gully breach of Trenches 1/2.
- It is also likely that the gully erosion will destabilize portions of the North slope. Potential landslides in the northern section of the East slope will affect at least the northeast corner of the trench area, and may extend some distance along Erdman Brook. This damage is also assumed to intersect the North ends of Trenches 3, 4, and 5.

Thus, the combined damage from these gully erosion conditions and potential corollary landslides is assumed to intersect Trenches 1/2, Trench 8, and the North ends of Trenches 3, 4, and 5. As noted previously, this extensive gully erosion can occur only during conditions when the geomembrane covers are removed and the engineered drainage control systems are not functioning normally.

6.4.5 References

- 6.4-1. "Assessment of Rill and Gully Erosion Processes at the State-licensed Disposal Area, West Valley Demonstration Project, New York", Bennett, S. J., Department of Geography, University at Buffalo, Buffalo, NY, August 2008
- 6.4-2. "Physical Hydrology", Dingman, S. L., Prentice Hall, Upper Saddle River, NJ, 2002
- 6.4-3. "Hydrologic Analysis and Design", McCuen, R. H., Prentice Hall, Upper Saddle River, NJ, 2004
- 6.4-4. "Time-of-Concentration Estimates", Aron, G., J. E. Ball, and T. A. Smith, *Journal of Irrigation and Drainage Engineering*, 117, 635-641, 1991
- 6.4-5. "Headcut Advance Prediction for Earth Spillways", Temple, D., and J. Moore, *Transactions of the ASAE*, 40, 557-562, 1997
- 6.4-6. "State-Licensed Disposal Area at West Valley 2006 Annual Report", New York State Energy Research and Development Authority, 2007

- 6.4-7. "Hydraulic Characteristics of Rills", Gilley, J. E., E. R. Kottwitz, and J. R. Simanton, *Transactions of the ASAE*, 33, 1900-1906, 1990
- 6.4-8. "Channel Width-Flow Discharge Relationships for Rills and Gullies", Torri, D., J. Poesen, L. Borselli, and A. Knapen, *Geomorphology*, 76, 273-279, 2006
- 6.4-9. "Characteristics of Actively Eroding Ephemeral Gullies in an Experimental Channel", Bennett, S. J., J. Casali, K. M. Robinson, and K. C. Kadavy, *Transactions of the ASAE*, 43, 641-649, 2000
- 6.4-10. "An Erosion Equation Derived from Basic Erosion Principles", Foster, G. R., L. D. Meyer, and C. A. Onstad, *Transactions of the ASAE*, 19, 678-682, 1982
- 6.4-11. "Resistance of Soils to Concentrated Flow Erosion: A Review", Knapen, A., J. Poesen, G. Govers, G. Gyssels, and J. Nachtergaele, *Earth-Science Reviews*, 80, 75-109, 2007
- 6.4-12. "Geotechnical Analysis of Soil Samples and Study of a Research Trench at the Western New York Nuclear Service Center, West Valley, New York", Hoffman, V. C., R. H. Fickies, R. H. Dana, Jr., and V. Ragan, NUREG/CR-1566, NYSGS/24.01.030, RE, RW, 1980
- 6.4-13. "Simulating Ephemeral Gully Erosion in AnnAGNPS", Gordon, L. M., S. J. Bennett, R. L. Bingner, F. D. Theurer, and C. V. Alonso, *Transactions of the American Society of Agricultural and Biological Engineers*, 50(3), 857-866, 2007
- 6.4-14. "Predicting Headcut Erosion and Migration in Concentrated Flows Typical of Upland Areas", Alonso, C. V., S. J. Bennett, and O. R. Stein, *Water Resources Research*, 38, 39-1, 39-15, 2002
- 6.4-15. "A Morphological Study of Headcut Growth and Migration in Upland Concentrated Flows", Bennett, S. J., C. V. Alonso, S. N. Prasad, and M. J. M. Romkens, *Water Resources Research*, 36, 1911-1922, 2000
- 6.4-16. "Erodibility of Cohesive Streambeds in the Loess Area of the Midwestern USA", Hanson, G. J., and A. Simon, *Hydrological Processes*, 15, 23-38, 2001
- 6.4-17. "Fluvial Processes in Geomorphology", Leopold, L. B., M. G. Wolman, and J. P. Miller, San Francisco, W.H. Freeman and Co., 1964

Table 6.4-1. Summary of Trench Characteristics				
Trench	Length (ft)	Width (ft)	Area (ft²)	Slope
1 & 2	678.12	25.00	16953.00	0.0116
3	678.12	25.00	16953.00	0.0120
4	643.12	25.00	16078.00	0.0087
5	577.50	25.00	14437.50	0.0099
6	193.00	8.00	1544.00	0.0192
7	88.00	13.00	1144.00	0.0167
8	546.88	25.00	13672.00	0.0004
9	546.88	25.00	13672.00	0.0054
10	546.88	25.00	13672.00	0.0059
11	546.88	25.00	13672.00	0.0069
12	533.75	25.00	13343.75	0.0072
13	595.00	25.00	14875.00	0.0094
14	634.38	25.00	15859.50	0.0047

Table 6.4-2. Gully Headcuts Parallel to Trenches (Figure 6.4-2)			
Rainfall Rate (in)	Conditional Probability		
	"High"	"Best"	"Low"
2	0.0000	0.0000	0.0000
3	0.0000	0.0000	0.0000
4	0.0000	0.0000	0.0000
5	0.0000	0.0000	0.0000
6	0.0000	0.0000	0.0000
7	0.0304	0.0000	0.0000
8	0.0912	0.0000	0.0000
9	0.1672	0.0000	0.0000
10	0.1672	0.0000	0.0000
11	0.1672	0.0000	0.0000
12	0.1976	0.0000	0.0000
13	0.2280	0.0000	0.0000
14	0.2584	0.0000	0.0000
15	0.3344	0.0000	0.0000
16	0.3344	0.0000	0.0000
17	0.3344	0.0000	0.0000
18	0.3648	0.0000	0.0000
19	0.3952	0.0304	0.0000
20	0.4408	0.0456	0.0000
21	0.4864	0.0608	0.0000
22	0.5168	0.0912	0.0000
23	0.5472	0.1216	0.0000
24	0.5776	0.1672	0.0000
25	0.5776	0.1672	0.0000
26	0.6080	0.1672	0.0000
27	0.6080	0.1672	0.0000
28	0.7144	0.1672	0.0000
29	0.7296	0.1672	0.0000
30	0.7448	0.1672	0.0000

Table 6.4-3. Rills Incision Perpendicular to Trenches (Figure 6.4-4)			
Rainfall Rate (in)	Conditional Probability		
	"High"	"Best"	"Low"
2	0.0000	0.0000	0.0000
3	0.0000	0.0000	0.0000
4	0.0160	0.0000	0.0000
5	0.0240	0.0000	0.0000
6	0.0320	0.0000	0.0000
7	0.0320	0.0000	0.0000
8	0.2000	0.0000	0.0000
9	0.2000	0.0000	0.0000
10	0.2920	0.0000	0.0000
11	0.2920	0.0000	0.0000
12	0.2920	0.0000	0.0000
13	0.3760	0.0000	0.0000
14	0.3760	0.0000	0.0000
15	0.3760	0.0000	0.0000
16	0.3760	0.0000	0.0000
17	0.3760	0.0000	0.0000
18	0.3760	0.0000	0.0000
19	0.3760	0.0000	0.0000
20	0.3760	0.0840	0.0000
21	0.3760	0.0840	0.0000
22	0.3760	0.0840	0.0000
23	0.3760	0.1680	0.0000
24	0.4600	0.1680	0.0000
25	0.4600	0.1680	0.0000
26	0.4600	0.1680	0.0000
27	0.4600	0.1680	0.0000
28	0.4600	0.1680	0.0000
29	0.4600	0.1680	0.0000
30	0.4600	0.2520	0.0000

Table 6.4-4. Summary of Potential Gully Locations				
Gully Location	Drainage Area (ft²)	Down-Valley Length of Drainage Area (ft)	Down-Valley Slope	Length to Nearest Trench (ft)
1	2591	63	0.077	85
2	4957	88	0.077	115
3	4908	69	0.038	121
4	2642	38	0.095	115
5	2465	41	0.125	115
6	2109	41	0.105	95
7	11300	126	0.318	180
8	8004	118	0.321	190

Table 6.4-5. Gullies Adjacent to the SDA (Figure 6.4-8)			
Rainfall Rate (in)	Conditional Probability		
	"High"	"Best"	"Low"
2	0.0250	0.0000	0.0000
3	0.1000	0.0000	0.0000
4	0.1500	0.0000	0.0000
5	0.1750	0.0250	0.0000
6	0.2250	0.0750	0.0000
7	0.2750	0.1000	0.0000
8	0.2750	0.1000	0.0000
9	0.3250	0.1250	0.0000
10	0.3250	0.1500	0.0000
11	0.3250	0.1500	0.0000
12	0.4000	0.1500	0.0000
13	0.4000	0.1750	0.0000
14	0.4000	0.1750	0.0000
15	0.4000	0.1750	0.0000
16	0.4250	0.2000	0.0000
17	0.4250	0.2000	0.0000
18	0.4250	0.2250	0.0000
19	0.4500	0.2250	0.0000
20	0.4750	0.2500	0.0000
21	0.5250	0.2750	0.0000
22	0.5250	0.2750	0.0000
23	0.5250	0.2750	0.0000
24	0.5500	0.2750	0.0000
25	0.5500	0.2750	0.0000
26	0.5500	0.2750	0.0000
27	0.5500	0.2750	0.0000
28	0.5500	0.3000	0.0000
29	0.5500	0.3000	0.0000
30	0.5500	0.3250	0.0000

Table 6.4-6. Gully Intersection with SDA Trenches (Figure 6.4-9)			
Rainfall Rate (in)	Conditional Probability		
	"High"	"Best"	"Low"
2	0.0000	0.0000	0.0000
3	0.0000	0.0000	0.0000
4	0.0000	0.0000	0.0000
5	0.0000	0.0000	0.0000
6	0.0000	0.0000	0.0000
7	0.0000	0.0000	0.0000
8	0.0000	0.0000	0.0000
9	0.0000	0.0000	0.0000
10	0.0000	0.0000	0.0000
11	0.0000	0.0000	0.0000
12	0.0000	0.0000	0.0000
13	0.0000	0.0000	0.0000
14	0.0000	0.0000	0.0000
15	0.0000	0.0000	0.0000
16	0.0000	0.0000	0.0000
17	0.0250	0.0000	0.0000
18	0.0250	0.0000	0.0000
19	0.0250	0.0000	0.0000
20	0.0250	0.0000	0.0000
21	0.0500	0.0000	0.0000
22	0.0500	0.0000	0.0000
23	0.0500	0.0000	0.0000
24	0.0500	0.0000	0.0000
25	0.0500	0.0000	0.0000
26	0.0500	0.0000	0.0000
27	0.0500	0.0000	0.0000
28	0.0500	0.0000	0.0000
29	0.0750	0.0000	0.0000
30	0.0750	0.0000	0.0000

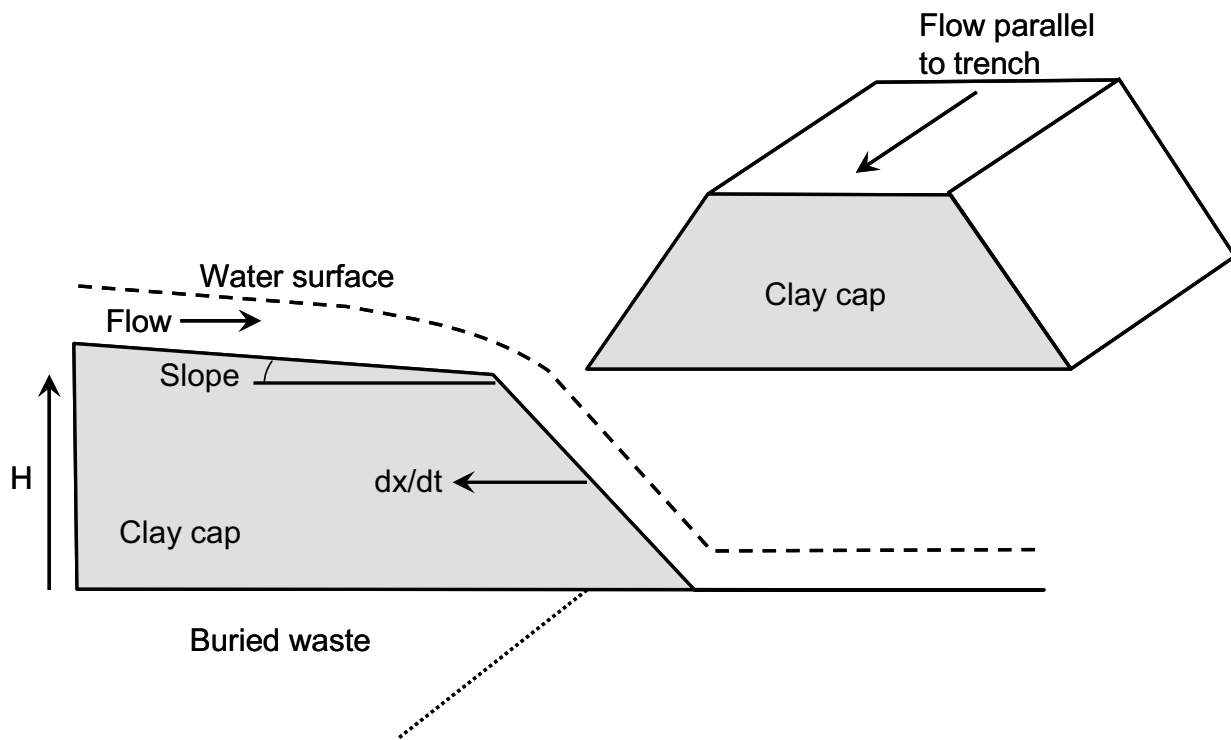

Flow over the cap is analogous to flow over an earthen embankment of height H whose overfall face migrates upstream at a rate of dx/dt . Water flows along the top of and parallel to the trench having slope S , creating an overfall and the end of the cap.

Figure 6.4-1. Conceptual Framework for the Gully Headcut Erosion through the Clay Cap

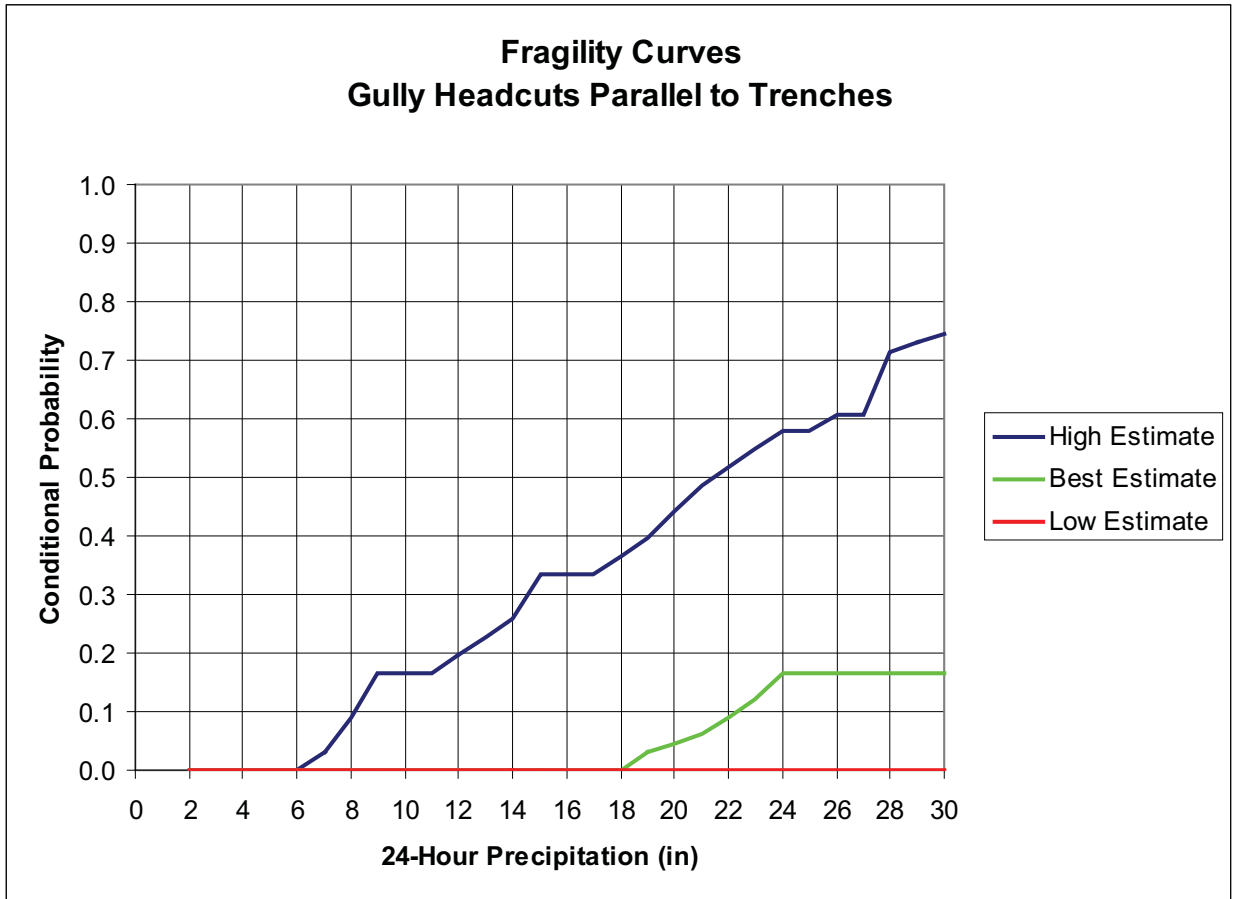

All conditional probabilities for all storm durations for all trenches were summed for a given 24-hr precipitation event.

Figure 6.4-2. Fragility Curves Derived for Gully Headcuts Occurring along the Top (parallel to) the Trenches

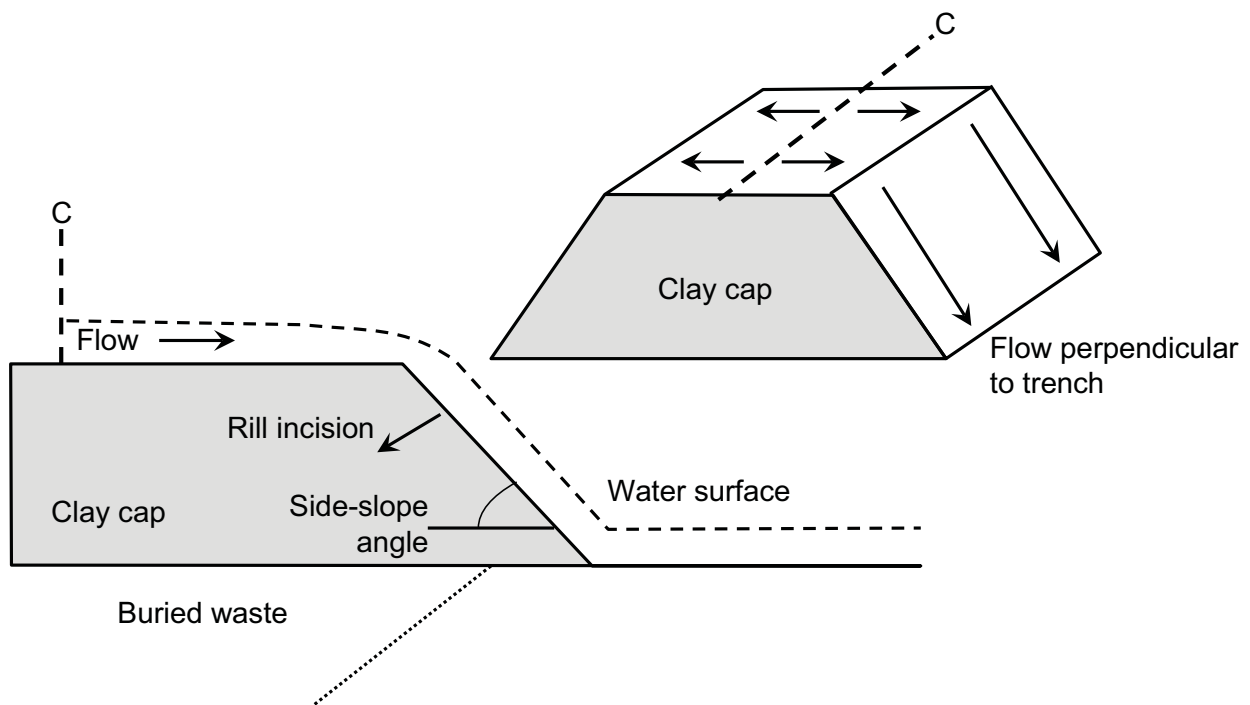

Water flows along the top of and parallel to the trench cap, and is split in two along the trench centerline C. Rills can form due the concentration of this flow as it travels down the cap side-slope, incising into the cap as it does so.

Figure 6.4-3. Conceptual Framework for the Rill Erosion of the Clay Cap

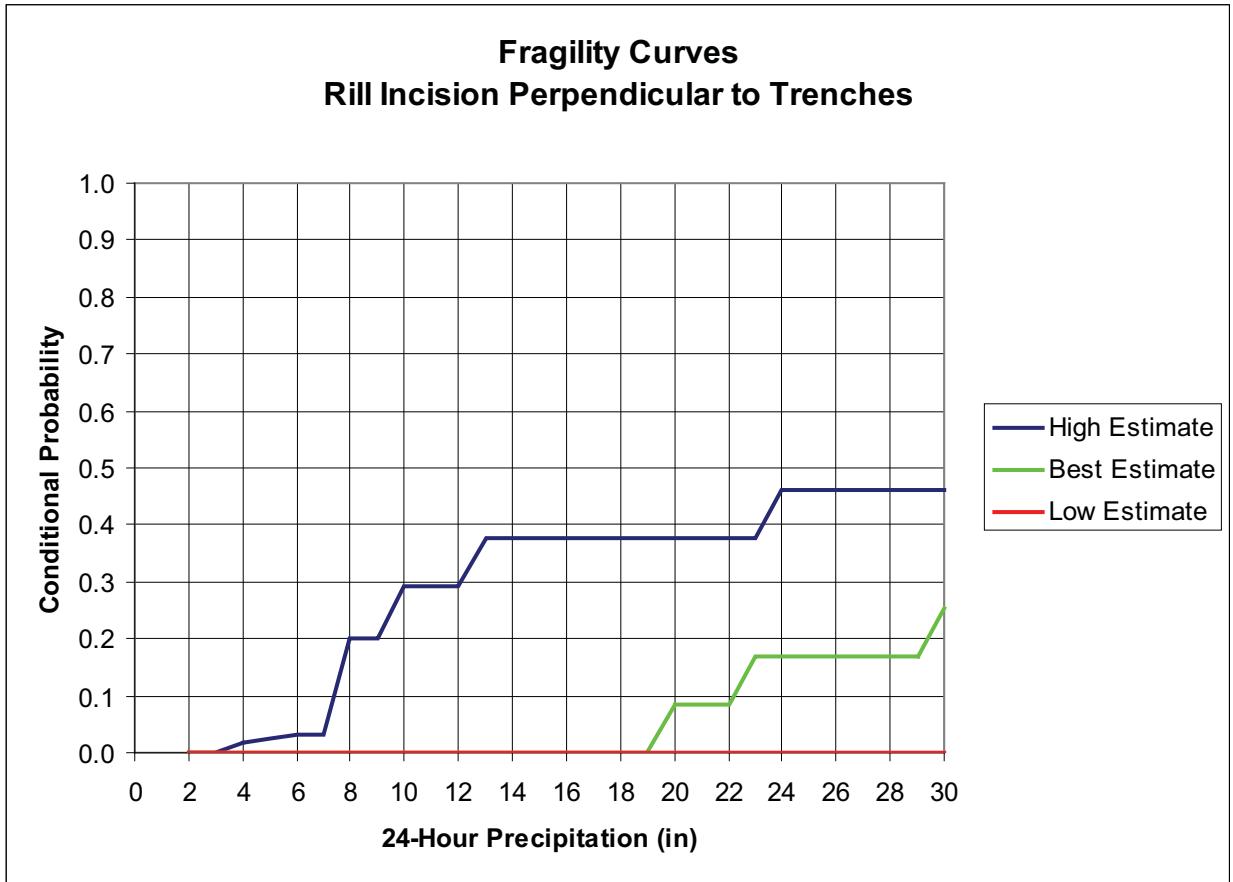

All conditional probabilities for all storm durations for all side-slopes were summed for a given 24-hr precipitation event.

Figure 6.4-4. Fragility Curves Derived for >1-m of Rill Incision Occurring along the Trenches Side-Slopes

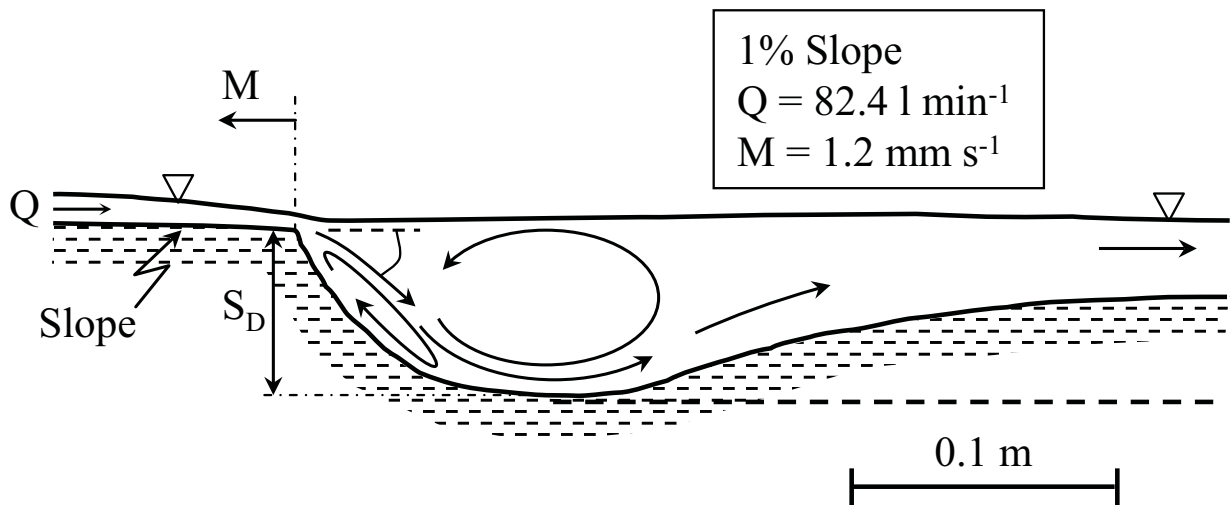

Scaled drawing of an actively migrating headcut scour hole from Bennett et al., with select parameters defined. Here, the overfall is nearly submerged and $h = 0.001 \text{ m}$ (see text).

Figure 6.4-5. Scaled Drawing of Actively Migrating Headcut Scour Hole (from Reference 6.4-15)

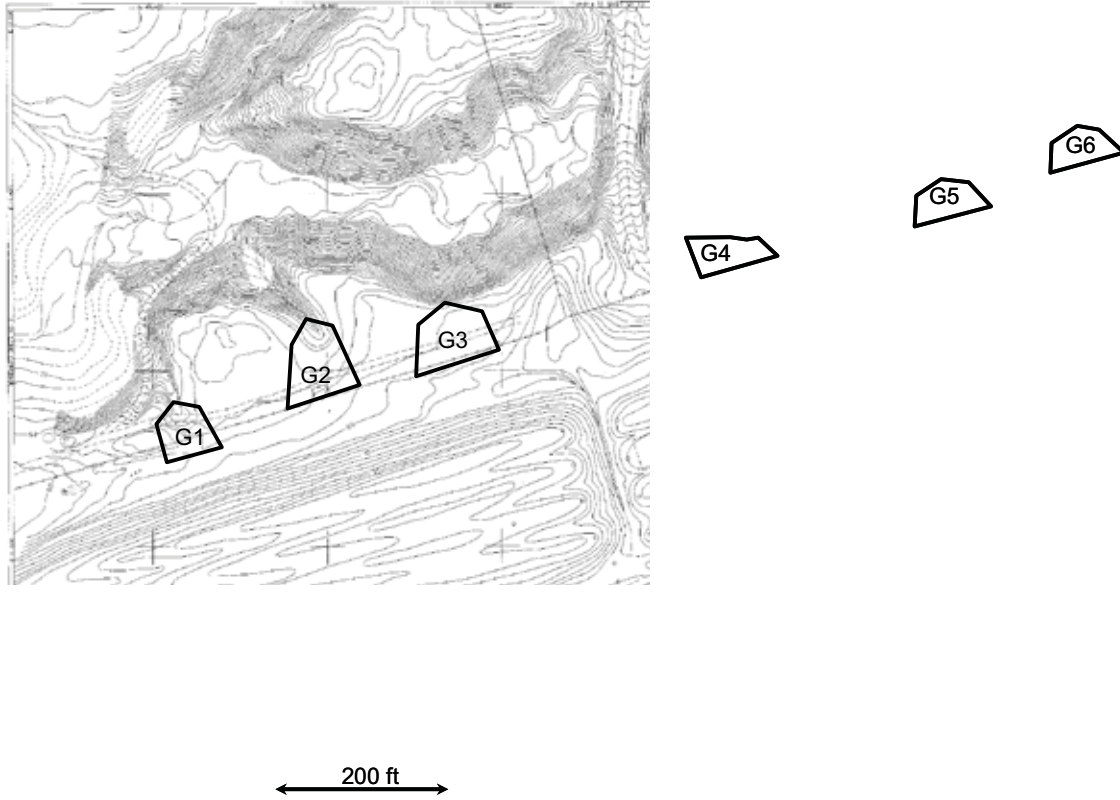

Postulated gully erosion locations (G1 to G6) along the eastern portion of the SDA. Solid line indicates approximate drainage area. Base map provided by NYSERDA.

Figure 6.4-6. Postulated Gully Erosion Locations along the Eastern Portion of the SDA

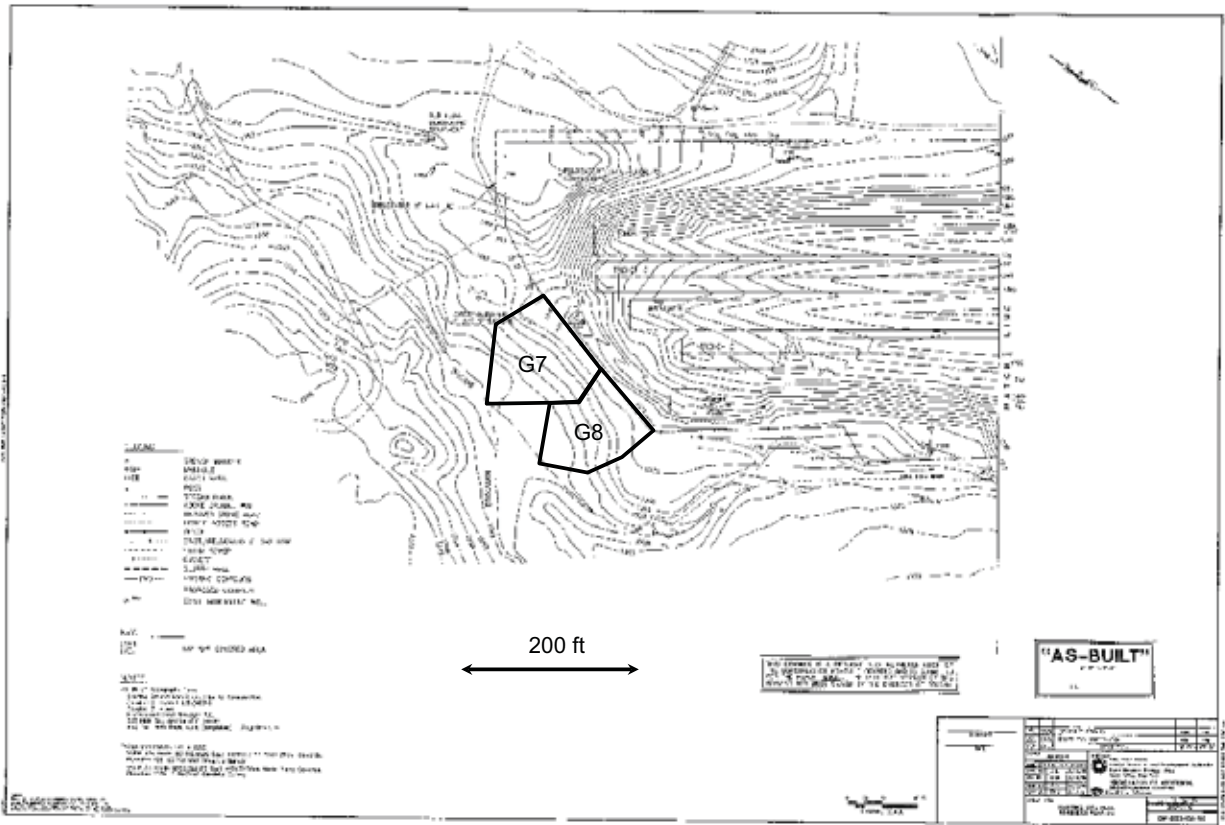

Postulated gully erosion locations (G7, G8) along the northwestern portion of the SDA. Solid line indicates approximate drainage area. Base map provided by NYSERDA.

Figure 6.4-7. Postulated Gully Erosion Locations along the Northwestern Portion of the SDA

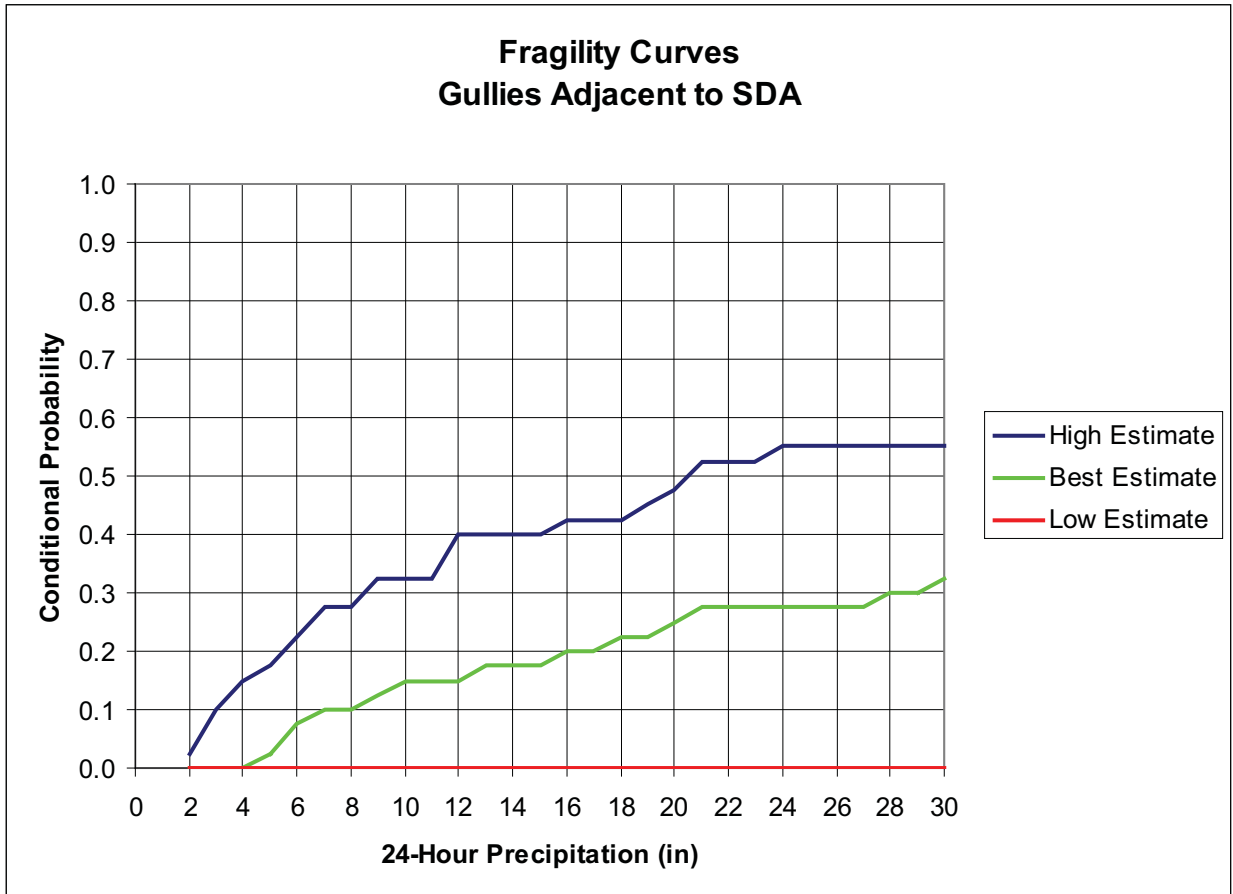

All conditional probabilities for all storm durations for all gullies were summed for a given 24-hr precipitation event.

Figure 6.4-8. Fragility Curves Derived for Actively Migrating Gullies from the Surrounding Areas of the SDA to Intersect the SDA Boundaries

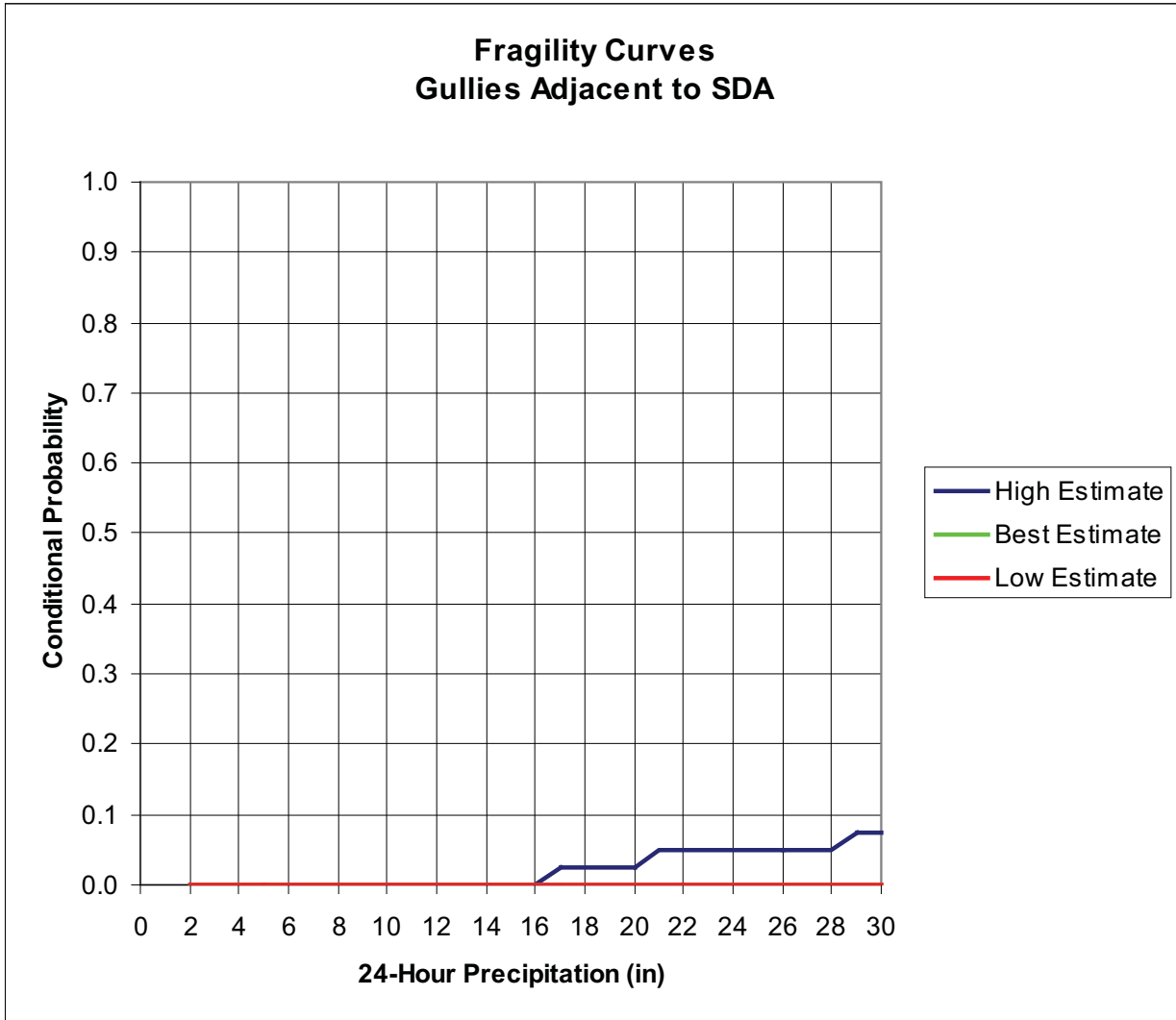

All conditional probabilities for all storm durations for all gullies were summed for a given 24-hr precipitation event.

Figure 6.4-9. Fragility Curves for Actively Migrating Gullies from the Surrounding Areas to Intersect the SDA Trenches, Geomembrane Covers Not Intact, Derived by QRA Team

6.5 GROUNDWATER PATHWAYS

The methodology and analytical models described in this section were developed by Dr. Shlomo P. Neuman and were submitted to the QRA team as part of the expert elicitation inputs for the study. Except for editorial formatting, the material in Sections 6.5.1 through 6.5.4 is reproduced verbatim from Dr. Neuman's report (Reference 6.5-1). Section 6.5.5 summarizes the QRA team's interpretation of these analyses and explains how the results are applied in the risk assessment models.

6.5.1 Problem Statement

The Question (as originally posed)

What is the likelihood of a release of 10%, 25%, 50%, 75%, or up to 100% of a non-sorbing contaminant, per unit concentration, to surface water through a groundwater pathway (horizontal and vertical) within 30 years? The analysis should consider the 30 years of past history.

The Question (reformulated, addressed below)

How to compute contaminant concentrations, mass release rates and associated uncertainties of a contaminant from trenches through horizontal and vertical groundwater pathways to the surface or to streams over a 30 – 60 year period, given a 15% discrete probability that water level in the trenches is at the top of each trench, 25% probability that it is at the weathered-unweathered Lavery till interface, 30% that it is at its current level in each trench, and 30% that it is below its current level, for a specified time series of contaminant concentrations in each trench?

Suggested Probability Modification

Water level records in the 1100 well series and the trenches suggest that, with the exception of trench 1, recent water levels in the trenches generally conform to those in the surrounding Unweathered Lavery Till. Both sets of water levels tend to decline downstream, toward Frank's Creek and Erdman Brook. This indicates lateral inflow into the trenches from the southwest, and lateral outflow toward the above streams, at the ULT level. Water levels in the Weathered Lavery Till are consistently higher than those in the ULT and the trenches, indicating sustained recharge of the trenches from the WLT on all sides. One may therefore expect water levels in the trenches to gradually stabilize close to their current values (close to those in the surrounding ULT), reducing substantially the probability that they would fall substantially below their current levels in the future. This requires reassessing the above probabilities.

6.5.2 Proposed Transport Model

In principle, both flow and contaminant transport at the site take place under transient conditions within a relatively complex and heterogeneous three-dimensional saturated-unsaturated domain. Due to programmatic constraints, it is found necessary to model flow and transport through this domain using a number of simplifying assumptions. I propose the following highly (over)simplified transport model, which in turn constrains the groundwater flow model described later.

Let $c_{oi}(t)$ be a record of contaminant concentrations in trench i ($i = 1, 2, \dots, 14$). Assume that, at time $t = 0$, concentrations outside the trenches are zero. Assume further that contaminant transport out of trench i takes place along the following pathways:

1. Horizontally through the WLT at a constant velocity v_{wi} through a rectangular flow channel of cross-section A_{wi} (contact area of trench i with the WLT perpendicular to the pathway) and length L_{wi} (shortest horizontal distance between this contact area and the surface) when H_i (head in the trench) is at the top of the trench; otherwise, no such horizontal transport takes place. Flow paths to the northeast (perpendicular to trench longitudinal axes) emanating from trenches other than 1, 2 and 8 are poorly defined in this model. A conservative approach would be to assign the highest concentration in Trenches 1 - 5 to 1 and 2, and the highest concentration in Trenches 8 - 14 to 8, on the assumption of complete mixing among the corresponding trenches, then consider northeast pathways only from 1, 2 and 8.
2. Horizontally through the ULT at a constant velocity v_{ui} through a rectangular flow channel of cross-section A_{ui} (contact area of saturated part of trench i with the ULT) and length L_{ui} (shortest horizontal distance between this contact area and the surface) when H_i (head in the trench) is above the trench bottom; otherwise, no such horizontal transport takes place. Flow paths to the northeast (perpendicular to trench longitudinal axes) emanating from trenches other than 1, 2 and 8 are poorly defined in this model. A conservative approach would be to assign the highest concentration in Trenches 1 - 5 to 1 and 2, and the highest concentration in Trenches 8 - 14 to 8, on the assumption of complete mixing among the corresponding trenches, then consider northeast pathways only from 1, 2 and 8.
3. Vertically through the ULT and the unsaturated zone of the Kent Recessional Sequence at a constant velocity v_{vi} through a rectangular flow channel of cross-section A_{vi} (bottom area of trench i) and length L_{vi} (shortest vertical distance between trench bottom and underlying KRS water table) when H_i (head in the trench) is above the trench bottom; otherwise, no such vertical transport takes place.
4. Horizontally through the KRS at a constant velocity v_{ki} through a rectangular flow channel of cross-section A_{ki} (I suggest setting it equal to the area of the KRS seepage face) and length L_{ki} (shortest horizontal distance between footprint of trench i and the KRS seepage face) under a hydraulic gradient g_i derived from existing water level measurements and geologic data in the KRS.

Consider first the auxiliary case where concentration in trench i is a unit step function occurring at time $t = 0$. Then concentration at the exit point for any of the above pathways, other than 5, is given by the following analytical expression (van Genuchten and Alves, 1982; see equation G-40 in Appendix G of EIS):

$$U_i(L_i, t) = 0.5 \exp[(v_i - u_i)L_i / (2a_i v_i)] \operatorname{erfc}\{(R_i L_i - u_i t) / [2 \sqrt{a_i v_i R_i t}]\} + 0.5 \exp[(v_i + u_i)L_i / (2a_i v_i)] \operatorname{erfc}\{(R_i L_i + u_i t) / [2 \sqrt{a_i v_i R_i t}]\} \quad (6.5.1)$$

where erfc is the complementary error function and

$$\begin{aligned} u_i &= \sqrt{v_i^2 + 4 b R_i a_i v_i} \\ a_i &= \text{longitudinal dispersivity} \end{aligned}$$

R_i = retardation coefficient (set to 1 in our case)
 b = radioactive decay coefficient.

If the trench concentration c_{oi} is constant then concentration at the exit point is given by

$$c_i(L_i, t) = c_{oi} U_i(L_i, s). \quad (6.5.2)$$

Otherwise, $c_i(L_i, t)$ is obtained through the Duhamel's temporal convolution integral

$$c_i(L_i, t) = \text{Integral (with respect to } s, \text{ from } s = 0 \text{ to } s = t) \text{ of } c_{oi}(t-s) dU_i(L_i, s) / ds. \quad (6.5.3)$$

The rate of contaminant mass exiting through the surface is

$$\text{Mass rate}_i(L_i, t) = A_i [v_i c_i(L_i, t) - a_i v_i dc_i(x, t) / dx]_{x=L_i} \quad (6.5.4)$$

where $c_i(x, t)$ is $c_i(L_i, t)$ expressed in terms of x instead of L_i . The total mass exiting over any time interval is the integral of (6.5.3) over that interval.

The input concentration $c_{ki}(L_i, t)$ for Pathway 5 is obtained by setting $\text{Mass rate}_i(L_i, t) = A_{ki} v_{ki} c_{ki}(L_i, t)$. In all other respects pathway 5 is treated as pathways 1 – 4.

6.5.3 Flow Model

The above requires a model to compute v_i for each pathway:

1. For horizontal flow through the WLT treat the latter as an unconfined aquifer with head h govern by $d/dx(hdh/dx) = 0$ or $dh^2/dx^2 = 0$. This means that h^2 varies linearly with distance x , yielding $h^2(x) = H_i^2 - (H_i^2 - H_{ie}^2)x / L_i$ where H_{ie} is head at the exit. Hence

$$v_{wi} = q_{wi} / n_{wi} = -K_{wi} / n_{wi} dh/dx = -K_{wi} / n_{wi} 1/2h dh^2/dx \sim K_{wi} / n_{wi} 1/2h_a (H_i^2 - H_{ie}^2) / L_i \quad (6.5.5)$$

where q_{wi} is Darcy flux, n_{wi} is advective (effective) porosity, K_{wi} is hydraulic conductivity, and h_a is average head.

2. For horizontal flow through the ULT when H_i is at or below the WLT/ULT interface, treat the ULT as an unconfined aquifer with head govern by $d/dx(hdh/dx) = 0$ or $dh^2/dx^2 = 0$. This means that h^2 varies linearly with distance x , yielding $h^2(x) = H_i^2 - (H_i^2 - H_{ie}^2)x / L_i$ where H_{ie} is head at the exit. Hence

$$v_{ui} = q_{ui} / n_{ui} = -K_{ui} / n_{ui} dh/dx = -K_{ui} / n_{ui} 1/22 dh^2/dx \sim K_{ui} / n_{ui} 1/2h_a (H_i^2 - H_{ie}^2) / L_i \quad (6.5.6)$$

where q_{ui} is Darcy flux, n_{ui} is advective (effective) porosity, K_{ui} is hydraulic conductivity, and h_a is average head.

3. For horizontal flow through the ULT when H_i is above the WLT/ULT interface, treat the ULT as a confined aquifer with head govern by $d^2h/dx^2 = 0$. This means that h varies linearly with distance x , yielding $h(x) = H_i - (H_i - H_{ie})x / L_i$ so that

$$v_{ui} = q_{ui} / n_{ui} = -K_{ui} / n_{ui} dh/dx = K_{ui} / n_{ui} (H_i - H_{ie}) / L_i. \quad (6.5.7)$$

4. For vertical flow through the ULT assume that gravity is the dominant driving force. Then the hydraulic gradient is equal to 1 and

$$v_{vi} = K_{vi} / n_{vi}. \quad (6.5.8)$$

5. For horizontal flow through the KRS treat the latter as an unconfined aquifer with head govern by $d/dx(hdh/dx) = 0$ or $dh^2/dx^2 = 0$. This means that h^2 varies linearly with distance x , yielding $h^2(x) = H_i^2 - (H_i^2 - H_{ie}^2)x / L_i$ where H_{ie} is head at the exit. Hence

$$V_{ki} = q_{ki} / n_{ki} = - K_{ki} / n_{ki} dh/dx = - K_{ki} / n_{ki} 1/22 dh^2/dx \sim K_{ki} / n_{ki} 1/2h_a (H_i^2 - H_{ie}^2) / L_i \quad (6.5.9)$$

where q_{ki} is Darcy flux, n_{ki} is advective (effective) porosity, K_{ki} is hydraulic conductivity, and h_a is average head.

6.5.4 Assessment of Uncertainty

Uncertainty impacts the following parameters in each unit: K , n , a , R , H and $c_o(t)$. These parameters can be assumed to be statistically independent of each other. Their uncertainties propagate through the above equations to impact computed velocities, concentrations and mass fluxes.

By considering only non-sorbing contaminants (a conservative approach) R is set equal to the deterministic value of 1.

K is commonly taken to be lognormal. Table E-3 (Reference 6.5-2) lists ranges for K values in the various units of interest and Figure E-19 plots K values of the ULT as a function of depth. We propose we obtain the original data and estimate the parameters of the corresponding lognormal distribution in each unit by maximum likelihood or some other approach. A lower bound on vertical ULT conductivity can be obtained from observations of trench water level recessions during the last 12 – 15 years since the trenches were covered.

The advective (effective) porosity n is generally smaller than the total porosity. As the WLT and shallow ULT are fractured, the advective porosity may be as low as that of the fractures. We propose assuming a uniform distribution between sampled values of total porosity provided in the EIS or other source documents and values as small as 0.001.

The dispersivity generally appears to be about 1/10 the travel distance, in our case $a_i = L_i/10$. We could either treat this as a deterministic parameter or vary it arbitrarily about this nominal value. **Note:** Reducing a_i has the effect of delaying contaminant arrival while increasing its peak concentration at the source.

Running the model in a Monte Carlo or other appropriate sampling mode can account for the above uncertainties.

Uncertainty in H_i can be accounted for by sampling this parameter from the discrete probability values discussed on p. 1.

Uncertainty in $c_o(t)$ can likewise be treated by sampling from an appropriate probability distribution for each contaminant in each trench.

6.5.5 Application of the Analyses

The following sections summarize the QRA team's interpretations of the groundwater pathway models and explain how the results are applied in the SDA risk assessment.

6.5.5.1 Flow Model / Transport Model Implementation

The flow and transport models described above were implemented as six integrated flow / transport models (FM/TM) in individual spreadsheets within a single workbook. (See Appendix 6.5A) They are designated as follows:

- WTLAT—FM1/TM1—lateral flow from Trenches 1/2, 8, 3, 4, and 5 through the Weathered Lavery Till (unconfined condition) to the nearest shallow creek, water level at top of trenches
- ULTLAT1—FM3/TM2—lateral flow from Trenches 1/2, 8, 3, 4, and 5 through the Unweathered Lavery Till (confined condition) to the nearest shallow creek, water level at top of trenches
- ULTLAT2—FM2/TM2—lateral flow from Trenches 1/2, 8, 3, 4, and 5 through the Unweathered Lavery Till (unconfined condition) to the nearest shallow creek, water level at WLT/ULT interface
- ULTLAT3—FM2/TM2—lateral flow from Trenches 1/2, 8, 3, 4, and 5 through the Unweathered Lavery Till (unconfined condition) to the nearest shallow creek, water level at 2008 levels (substantially below WLT/ULT interface)
- ULTVERT—FM4/TM3—vertical flow (gradient = 1) from all trenches except 6 and 7 through the Unweathered Lavery Till to the top of the Kent Recessional Sequence
- KRS—FM5/TM4—lateral flow from a point directly beneath the trenches through the Kent Recessional Sequence (unconfined condition) to Buttermilk Creek

The first four FM/TM models represent individual complete flow paths from the SDA trenches to surface streams. The latter two represent two path segments in a single "down and out" flow path—vertical flow downward through the bottom of the trenches, through the Unweathered Lavery Till (ULTVERT), into the Kent Recessional Unit, and then laterally through the Kent Recessional Unit to Buttermilk Creek. For modeling purposes, these two segments are linked in two ways. First, if the independently calculated ratio C/C_o for the KRS segment, exceeds the ratio C/C_o calculated for the vertical segment, the ratio C/C_o is reset to the value for the vertical segment (i.e., C/C_o for the KRS is not allowed to exceed C/C_o for the ULT vertical segment). Second, if independently calculated trench water flow rate through the KRS is exceeded by the flow rate calculated for ULT vertical segment, K_h for the KRS is reset so that the KRS flow rate is large enough to accommodate the flow rate from the trenches. Except to the extent affected by these linkages, releases through the "down and out" flow path are modeled as though trench water were introduced directly into the KRS unit across a vertical plane perpendicular to the KRS flow path just beneath the SDA trenches.

A separate single worksheet was used for the tabulation of all input data provided for all of the models. The same single worksheet was used also to collect output from the models—

groundwater flow rate, Q (cfs), the ratio of constituent concentration in the output flow to the constituent concentration in the input flow, C/C_o , at the flow path exit point after 60 years, and the product of the two, termed mass rate (cfs). (In these analyses, C_o is taken to be the average concentration of radionuclides in trench water and is assumed to be constant throughout the period of evaluation. Radionuclide decay during this period and during transport is also essentially ignored (as explained below). These assumptions are discussed further in Section 9.) The mass rate is the product of Q and C/C_o , and can be thought of as the flow rate of water containing constituent concentration C_o equivalent in terms of constituent transport rate to the flow rate of water containing constituent concentration C .

6.5.5.2 Input Assumptions

Groundwater flow and contaminant transport calculations included consideration of several factors that physically describe the pathway along which groundwater flows and the natural materials that comprise that pathway. Some of these factors are physical properties that are known to vary laterally and vertically for the glacial deposits in which shallow groundwater occurs at the Western New York Nuclear Service Center. For these groundwater flow and contaminant transport calculations, the varied values were advective porosity (also effective porosity, or the porosity available for flow of fluid containing dissolved solutes) and hydraulic conductivity (the capacity of a porous medium to transmit water through a unit cross-sectional area of that medium). The manner by which the varied values of advective porosity (n_a) and hydraulic conductivity (K_v and K_h for horizontal and vertical hydraulic conductivity, respectively) were varied is described at the end of this section. The non-varied values were the physical characteristics and dimensions that describe the flow pathway. The determination of non-varied (discrete) values is described below:

Soil Bulk Density (rho or ρ)

The bulk densities for two materials, glacial till (silt/clay) and recessional sequence (sand/gravel), were considered in the calculations. The dry bulk density assumed applicable to all glacial till materials (WLT and ULT) was 105 pounds per cubic foot, or $\rho = 1.68$. The dry bulk density assumed applicable to all recessional sequence materials (KRS) was 120 pounds per cubic foot, or $\rho = 1.92$. Both values were assumed on the basis of values usually associated with materials with these textural (particle size) descriptions. Density values measured and reported for these materials at the Center are 1.60 and 2.03 for till and till sand materials, respectively (Reference 6.5-3).

Dispersivity, Longitudinal (a)

Longitudinal dispersivity is a physical phenomenon that quantifies how groundwater flow containing dissolved solute will deviate from a straight-line groundwater flow path, causing the plume to spread horizontally. A nominal value for L_1 of 10% of the travel distance was used in these calculations.

Decay, Radioactive (R)

Although radioactive decay is explicitly included in the models, its effect was essentially ignored by setting the radioactive decay half-life to 1,000 years.

Flow Path Length (L_i)

The shortest (straight-line) length of the groundwater flow path from SDA trenches to the discharge point. The flow path length was a different discrete value for each of the four groundwater flow paths considered – horizontally in the WLT and ULT to discharge at Erdman Brook and Frank's Creek, vertically in the ULT to discharge to the KRS, and horizontally in the KRS toward discharge at Buttermilk Creek. The flow initiation points for the shorter horizontal pathways (WLT and ULT) were at Trench 4 or Trenches 1/2, and the associated discharge points were at either Erdman Brook or Frank's Creek. The flow initiation point for flow in the KRS toward Buttermilk Creek was the northeastern SDA boundary and the flow path length was the distance northeastward to Buttermilk Creek. A northeastward groundwater flow direction in the KRS was used based on Figure 15 of USGS Professional Paper 1325 (Reference 6.5-4). The flow path considered for the vertical flow scenario was the vertical distance from a typical SDA trench bottom to the groundwater level in the underlying KRS.

Flow (window) Area (A)

Flow area is a calculated value (height times length) representing the size of the wetted window, oriented perpendicularly to the direction of groundwater flow, through which groundwater would flow from the SDA trench(es) to the discharge point. The flow area was different for each of the four discrete flow paths.

- For horizontal flow paths in the WLT and ULT, the flow window was oriented vertically. The length or horizontal dimension of the window was assumed to be the full length of Trenches 1 and 2 for flow toward Frank's Creek and the combined widths of Trenches 2, 3, 4 and 5 (in a direction perpendicular to the shortest pathway to the creek) for flow toward Erdman Brook. The height of the window was the vertical dimension from the fluid level in the trench to the bottom of the trench. This is the wetted height of the flow window. Four fluid levels were considered, representing the following:
 - Elevation of the top of the trench (a specific value for each trench at the flow initiation end of the flow path)
 - Elevation of the transition from WLT to ULT (a specific average value for each trench at the flow initiation end of the flow path)
 - Elevation of trench fluid in March 2008 (a specific measured value for each trench at the flow initiation end of the flow path)
 - Elevation of the trench bottom (assuming the trenches are "dry", i.e., there was no fluid in the trenches)
- For horizontal flow in the KRS toward Buttermilk Creek, the flow window was oriented vertically. The length or horizontal dimension of the window was assumed to be the full width (measured in a direction perpendicular to the shortest pathway to the creek) of the entire SDA. The full width of the SDA (estimated to be 1,000 feet) was considered because all SDA trenches (not including Trench 6) were assumed to be potential contributors to this groundwater flow scenario. The height of the window was the vertical thickness of the saturated portion of the KRS, estimated to be 7 meters or 23 feet.

- For vertical flow (in the ULT) to the KRS, the flow window was oriented horizontally and was assumed to be equal to the combined bottom areas of 13 SDA trenches (not including Trench 6).

Gradient (i)

Gradient is a calculated value based on the difference between the elevations (H_i and H_e) of groundwater at the initial and exit points of the flow path divided by flow path length (L_i) for horizontal flow scenarios. The gradient, head level change divided by flow path length, was assumed to be 1.0 for vertical flow in the ULT.

Head, Initial (H_i)

Initial head, or "head in the trench," was a value equal to the elevation of groundwater in the trench located at the initiation end of the flow path for each groundwater flow scenario. The initial head value was a different specific value for each of the four trench fluid levels (see definition of flow area, A) for each trench considered in the flow calculations.

Head, Exit (H_e)

Exit head, or groundwater elevation at the discharge (exit) point, was the estimated surface-water elevation in Erdman Brook, Frank's Creek, or Buttermilk Creek (depending on the flow path being considered).

6.5.5.3 Uncertainties

As noted by Dr. Neuman's report, uncertainty impacts the following parameters in each unit: K, n, a, R, H, L and $C_o(t)$. These parameters can be assumed to be statistically independent of each other. Their uncertainties propagate through the above equations to impact computed velocities, concentrations and mass fluxes.

H, L and a have been considered deterministic parameters because they are considered to be discrete (or related) values. They are important descriptors of the groundwater flow pathways, but the likely ranges of their values is too small to make them substantial contributors to overall uncertainty in the results.

In considering only non-sorbing contaminants in the models discussed here, (a conservative approach), R (retardation) is set equal to the deterministic value of 1. This is considered appropriate for the models WLTLAT, ULTLAT1, and ULTLAT2. In those cases, substantial portions of the flow pass through fractured media, limiting potential for retardation. For models ULTLAT3, ULTVERT, and KRS, however, flow is assumed to pass predominantly through unfractured media. Furthermore, sensitivity studies using the models show that values of K_d , (distribution coefficient, the equilibrium ratio of concentration of constituent in solids to the concentration in water in contact with the solids, units of mL/g) as low as 10 mg/L result in no constituent release over a very broad part of the range of variability in the other model parameter values. As explained in Section 9.3.1, K_d values for all but the essentially non-retarded nuclides ($H3$, I129, Tc99, and C14) are all greater than 10 mL/g. Most are far greater. This finding suggests that, while the full spectrum of nuclides should be considered released unretarded in the first three models, only poorly retarded nuclides should be considered released (with no retardation) in the others. For these cases, other nuclides can be considered

entirely confined to the groundwater system, if not to the trenches, for the period of interest. This finding and its implications are discussed further in Section 9.

Because of their large ranges of likely values and their importance in the determination of the mass rate output at 60 years, K_h , K_v and n have been treated probabilistically. Distributions for n , advective porosity, were assumed to be uniform, with upper bound values corresponding to reasonable values for unfractured media, and lower bound values adjusted to reflect higher effective pore velocities expected for fractured media in the WLT and upper ULT at the SDA site. Minimum values of 0.001 were chosen for the WLTAT, ULTLAT1, and ULTLAT2 models. A value of 0.01 was chosen for ULTLAT3, to reflect some possible transition to the more fractured upper part of this zone. Lower limits of 0.17 and 0.19 were chosen for the lower bounds of the distributions for the ULTVERT and KRS models as reasonable values for unfractured media.

Probability distributions were also used for K_h and K_v . Distributions were assumed to be lognormal with parameters selected on available data and judgment. In general, values representing the upper and lower bounds of ranges of values considered to span 95% of the distribution were identified. Because the upper ends of these ranges often approach or exceed reasonably expected physical limits, the resultant distributions were truncated at the 97.5 percentile level to prevent overweighting of the distributions by values higher than reasonably supportable. The approaches used and bases for them are described briefly below. Additional discussion of the bases is provided in Appendix 6.5B.

Unweathered Lavery Till

The 20 values plotted in Figure E-19 in the May 2008 Geohydrology Appendix E (Reference 6.5-2) were used to establish the range of K_h values for the ULT, $1E-11$ to $2E-6$ m/s. The value of $2.0E-10$ m/sec, a minimum value of K_v calculated from trench fluid level decline rates, was also considered. Values in the range of $1E-10$ m/sec for the ULT are also consistent with other references. Because Table E-3 in the May 2008 Geohydrology Appendix E indicates that $K_h=K_v$ for the ULT, selection of ULT K distribution values takes no account of anisotropy in that unit.

The upper bound of $1E-5$ m/s for upper ULT in ULTLAT1 and ULTLAT2 is intended to account for higher conductivity through fractures in those zones. The upper bound of $1E-6$ m/s for the lower ULT in ULTLAT3 is intended to limit trench turnover times to a minimum of 1 year or longer, consistent with apparent behavior.

A somewhat narrower K_v range was selected for vertical flow through the lower ULT. The lower bound was chosen to be close to the minimum value based on trench fluid level decline rates. The upper bound of $2E-8$ m/s was intended to limit trench turnover times to a minimum of 1 year or longer, consistent with apparent behavior.

Weathered Lavery Till

The single value K_h value for the WLT from Table E-3 (Reference 6.5-2), $4.65E-7$ m/s, and the listed range were used as starting points. The listed range $2E-8$ to $5E-6$ m/s was broadened slightly, particularly at the high end to account sufficiently for increased conductivity due to fracturing.

Kent Recessional Sequence

Point estimates of Kh for the Kent Recessional Sequence are available from previously cited sources and from the 1993 site EIS (Reference 6.5-3):

Information Source	Low	High
WVDP-EIS-009-REV 0, EID Vol. III, Part 4, page 59 (1993)	5.5E-09 m / sec	1.5E-08 m / sec
WVDP-EIS-009-REV 0, EID Vol. III, Part 4, page 59 (1993)	8.4E-08 m / sec	8.4E-07 m / sec
USGS PP1325, D. E. Prudic (1986)		1.0E-06 m / sec
Draft EIS, Appendix E, Table E-3 (May 2008)		1.6E-06 m / sec
Draft EIS, Appendix E, Page E-25 (May 2008)		1.78E-06 m / sec

These data provide a Kh value range. Although this data set is insufficient in itself to characterize an underlying distribution fully, the long flow path and likely significant variations in the geologic depositional environment would suggest finer-grained material deposits and a significant likelihood for Kh values toward the lower end of the range.

In summary, uniform distributions were used for n, advective porosity (dimensionless):

Model	n (range)	Basis
WLTLAT	0.001-0.324	Representative, except low end reflects fracturing
ULTLAT1	0.001-0.324	Representative, except low end reflects fracturing
ULTLAT2	0.001-0.324	Representative, except low end reflects fracturing
ULTLAT3	0.01-0.324	Representative, except low end reflects transition to more fractured upper levels
ULTVERT	0.170-0.324	Representative
KRS	0.190-0.270	Representative

Lognormal distributions, truncated at the 97.5 percentile value, were used for Kh (m/s):

Model	Kh (2.5%-97.5% range)	Basis
WLTLAT	1.0E-8 to 1.0E-5	See text
ULTLAT1	1.0E-11 to 1.0E-5	See text
ULTLAT2	1.0E-11 to 1.0E-5	See text
ULTLAT3	1.0E-11 to 1.0E-6	See text

Model	Kh (2.5%-97.5% range)	Basis
ULTVERT	1.0E-10 to 2.0E-8	See text
KRS	5.5E-9 to 1.0E-6	See text

6.5.5.4 Results and Discussion

Parameters of the output probability distributions of the mass rate (trench water concentration-equivalent flow rate) (cfs), conditional on the assumed trench fluid state, are listed for each of the six integrated FM/TM models in the table below:

Model	5th Percentile	Median	Mean	95th Percentile
WLTAT	9.57E-05	3.26E-03	9.83E-03	4.27E-02
ULTLAT1	0.00E+00	3.76E-05	4.99E-03	2.47E-02
ULTLAT2	0.00E+00	1.35E-05	3.84E-03	1.90E-02
ULTLAT3	0.00E+00	2.72E-12	1.87E-04	1.03E-03
ULTVERT	0.00E+00	4.36E-05	8.68E-04	4.25E-03
KRS	0.00E+00	5.16E-18	1.22E-04	4.45E-04

6.5.6 References

- 6.5-1. "On Groundwater Pathway Modeling", Neuman, S. P., SDA QRA expert elicitation input, West Valley, New York, July 23, 2008
- 6.5-2. Draft EIS, Appendix E, Table E-3, May 2008
- 6.5-3. WVDP-EIS-009-REV 0, EID Vol. III, Part 4, 1993
- 6.5-4. "Ground-Water Hydrology and Subsurface Migration of Radionuclides at a Commercial Radioactive-Waste Burial Site, West Valley, Cattaraugus County, New York," Prudic, David E., USGS Survey Professional Paper 1325, U.S. Government Printing Office, Washington, D.C., 1986

APPENDIX 6.5A

GROUNDWATER FLOW / TRANSPORT MODELS

Listings of the groundwater flow / transport models, showing equations, and inputs, intermediate results and complete results for sample problems are included in this appendix.

**WEATHERED LAVERY TILL - HORIZONTAL FLOW - UNCONFINED CONDITION
 COMBINES FLOW FROM TRENCHES 1/2, 3, 4, & 5 FOR TRENCH FLUID LEVEL 1 (TOP OF TRENCH)**

#1 FLOW MODEL
 #1 TRANSPORT MODEL

Calculations necessary:

- 1 Trench 1 to Franks Creek in WLT w/ trench fluid at highest level (trench top)
- 2 Trench 2 to Franks Creek in WLT w/ trench fluid at highest level (trench top)
- 3 Trench 8 to Franks Creek in WLT w/ trench fluid at highest level (trench top)
- 4 Trenches 2, 3, 4 and 5 to Erdman Brook in WLT w/ trench fluid at highest level (trench top)

RESULT FOR GIVEN INPUTS

4.56E-04 Q Q=na(AV) = AKi, Discharge volume, m³/sec
 1.61E-02 Q Discharge volume, CF/sec
 5.08E+05 Q Discharge volume, CF/year
 9.99E-01 CL/Co At 60 years
 1.61E-02 Mass Rate (CL/Co) Q, CF/sec

INPUTS

1.68 rho soil bulk density, g/ml
 1104.1 A cross-sectional area for flow path, m²
 51.2 L minimum flow path length, m
 421.5 Hi water level in trench, at beginning of flow path, m
 406.9 He water level in creek, at end of flow path, m
 5.12 a longitudinal dispersivity = Li/10, m
 2.20E-11 b rad decay const, 1/s
 0.321 na advective porosity
 1.45E-06 Kv hydraulic conductivity, m/s
 0.0 Kd solid/liquid partition coefficient, ml/g

Discrete input values - do not modify

UNIT CONVERSION CONSTANTS

3.15E+07 s/y

GENERAL COMPUTED

1.29E-06 v water velocity, m/s $(Kv/na)/(2*(Hi/2+He/2))*(Hi*Hi-He*He)/(L)$
 1 R retardation coefficient $(1+\rho*(1-na)*Kd/na)$ (SAIC EIS APPG 1995)
 1.26E+00 Tw path travel time for water, yr $(L/v)/3.15e7$
 1.26E+00 Tc path travel time for constituent (no retardation) yr $(L/v*R)/3.15e7$
 1.29E-06 u $SQRT(v^4+4*b*R*a*v)$

TIME-DEPENDENT QUANTITIES COMPUTED BELOW

X1	$(v-u)^*L/(2^*a^*v)$
X2	$(v+u)^*L/(2^*a^*v)$
X3	R^*L-u^*t
X4	R^*L+u^*t
X5	$2^*SQRT(a^*v^*R^*t)$
X6	$ERF(X3/X5)$ Note: $erf(-x) = -erf(x)$ and $erf(x) = 2^*NORMSDIST(SQRT(2)^*x)-1$ (see http://support.microsoft.com/kb/893352)
X7	$ERFC(X3/X5)$ Note: $ERFC(X) = 1 - ERF(X)$
X8	$ERF(X4/X5)$ Note: $erf(-x) = -erf(x)$ and $erf(x) = 2^*NORMSDIST(SQRT(2)^*x)-1$ (see http://support.microsoft.com/kb/893352)
X9	$ERFC(X4/X5)$ Note: $ERFC(X) = 1 - ERF(X)$
CL/Co	$0.5^*EXP(X1)^*ERFC(X3/X5)+0.5^*EXP(X2)^*ERFC(X4/X5)$

T, v	t, s	X1	X2	X3	X4	X5	X6	X7	X8	X9	Cl/Co
0.1	3.15E+06	-8.76E-04	1.00E+01	4.71E+01	5.53E+01	9.12E+00	1.00000	0.00000	1.00000	0.00000	1.35E-13
0.2	6.31E+06	-8.76E-04	1.00E+01	4.31E+01	5.93E+01	1.29E+01	1.00000	0.00000	1.00000	0.00000	2.02E-06
0.3	9.46E+06	-8.76E-04	1.00E+01	3.90E+01	6.34E+01	1.58E+01	0.99952	0.00048	1.00000	0.00000	3.93E-04
0.4	1.26E+07	-8.76E-04	1.00E+01	3.50E+01	6.75E+01	1.82E+01	0.99326	0.00674	1.00000	0.00000	5.24E-03
0.5	1.58E+07	-8.76E-04	1.00E+01	3.09E+01	7.15E+01	2.04E+01	0.96777	0.03223	1.00000	0.00000	2.39E-02
0.6	1.89E+07	-8.76E-04	1.00E+01	2.68E+01	7.56E+01	2.23E+01	0.91046	0.08954	1.00000	0.00000	6.37E-02
0.7	2.21E+07	-8.76E-04	1.00E+01	2.28E+01	7.97E+01	2.41E+01	0.81772	0.18228	1.00000	0.00000	1.25E-01
0.8	2.52E+07	-8.76E-04	1.00E+01	1.87E+01	8.37E+01	2.58E+01	0.69460	0.30540	1.00000	0.00000	2.02E-01
0.9	2.84E+07	-8.76E-04	1.00E+01	1.46E+01	8.78E+01	2.74E+01	0.55054	0.44946	0.99999	0.00001	2.88E-01
1	3.15E+07	-8.76E-04	1.00E+01	1.06E+01	9.18E+01	2.88E+01	0.39575	0.60425	0.99999	0.00001	3.76E-01
2	6.31E+07	-8.76E-04	1.00E+01	-3.01E+01	1.32E+02	4.08E+01	-0.70264	1.70264	1.00000	0.00000	8.99E-01
3	9.46E+07	-8.76E-04	1.00E+01	-7.07E+01	1.73E+02	5.00E+01	-0.95461	1.95461	1.00000	0.00000	9.87E-01
4	1.26E+08	-8.76E-04	1.00E+01	-1.11E+02	2.14E+02	5.77E+01	-0.99365	1.99365	1.00000	0.00000	9.98E-01
5	1.58E+08	-8.76E-04	1.00E+01	-1.52E+02	2.54E+02	6.45E+01	-0.99914	1.99914	1.00000	0.00000	9.99E-01
6	1.89E+08	-8.76E-04	1.00E+01	-1.93E+02	2.95E+02	7.07E+01	-0.99988	1.99988	1.00000	0.00000	9.99E-01
7	2.21E+08	-8.76E-04	1.00E+01	-2.33E+02	3.36E+02	7.63E+01	-0.99998	1.99998	1.00000	0.00000	9.99E-01
8	2.52E+08	-8.76E-04	1.00E+01	-2.74E+02	3.76E+02	8.16E+01	-1.00000	2.00000	1.00000	0.00000	9.99E-01
9	2.84E+08	-8.76E-04	1.00E+01	-3.15E+02	4.17E+02	8.65E+01	-1.00000	2.00000	1.00000	0.00000	9.99E-01
10	3.15E+08	-8.76E-04	1.00E+01	-3.55E+02	4.58E+02	9.12E+01	-1.00000	2.00000	1.00000	0.00000	9.99E-01
12	3.78E+08	-8.76E-04	1.00E+01	-4.36E+02	5.39E+02	9.99E+01	-1.00000	2.00000	1.00000	0.00000	9.99E-01
14	4.42E+08	-8.76E-04	1.00E+01	-5.18E+02	6.20E+02	1.08E+02	-1.00000	2.00000	1.00000	0.00000	9.99E-01
16	5.05E+08	-8.76E-04	1.00E+01	-5.99E+02	7.01E+02	1.15E+02	-1.00000	2.00000	1.00000	0.00000	9.99E-01
18	5.68E+08	-8.76E-04	1.00E+01	-6.80E+02	7.83E+02	1.22E+02	-1.00000	2.00000	1.00000	0.00000	9.99E-01
20	6.31E+08	-8.76E-04	1.00E+01	-7.61E+02	8.64E+02	1.29E+02	-1.00000	2.00000	1.00000	0.00000	9.99E-01
22	6.94E+08	-8.76E-04	1.00E+01	-8.43E+02	9.45E+02	1.35E+02	-1.00000	2.00000	1.00000	0.00000	9.99E-01
24	7.57E+08	-8.76E-04	1.00E+01	-9.24E+02	1.03E+03	1.41E+02	-1.00000	2.00000	1.00000	0.00000	9.99E-01
26	8.20E+08	-8.76E-04	1.00E+01	-1.01E+03	1.11E+03	1.47E+02	-1.00000	2.00000	1.00000	0.00000	9.99E-01
28	8.83E+08	-8.76E-04	1.00E+01	-1.09E+03	1.19E+03	1.53E+02	-1.00000	2.00000	1.00000	0.00000	9.99E-01
30	9.46E+08	-8.76E-04	1.00E+01	-1.17E+03	1.27E+03	1.58E+02	-1.00000	2.00000	1.00000	0.00000	9.99E-01
32	1.01E+09	-8.76E-04	1.00E+01	-1.25E+03	1.35E+03	1.63E+02	-1.00000	2.00000	1.00000	0.00000	9.99E-01
34	1.07E+09	-8.76E-04	1.00E+01	-1.33E+03	1.43E+03	1.68E+02	-1.00000	2.00000	1.00000	0.00000	9.99E-01
36	1.14E+09	-8.76E-04	1.00E+01	-1.41E+03	1.51E+03	1.73E+02	-1.00000	2.00000	1.00000	0.00000	9.99E-01
38	1.20E+09	-8.76E-04	1.00E+01	-1.49E+03	1.60E+03	1.78E+02	-1.00000	2.00000	1.00000	0.00000	9.99E-01
40	1.26E+09	-8.76E-04	1.00E+01	-1.57E+03	1.68E+03	1.82E+02	-1.00000	2.00000	1.00000	0.00000	9.99E-01
45	1.42E+09	-8.76E-04	1.00E+01	-1.78E+03	1.88E+03	1.94E+02	-1.00000	2.00000	1.00000	0.00000	9.99E-01
50	1.58E+09	-8.76E-04	1.00E+01	-1.98E+03	2.08E+03	2.04E+02	-1.00000	2.00000	1.00000	0.00000	9.99E-01
55	1.73E+09	-8.76E-04	1.00E+01	-2.18E+03	2.29E+03	2.14E+02	-1.00000	2.00000	1.00000	0.00000	9.99E-01
60	1.89E+09	-8.76E-04	1.00E+01	-2.39E+03	2.49E+03	2.23E+02	-1.00000	2.00000	1.00000	0.00000	9.99E-01

UNWEATHERED LAVERY TILL - HORIZONTAL FLOW - UNCONFINED CONDITION
 COMBINES FLOW FROM TRENCHES 1/2, 8, 3, 4, & 5 FOR TRENCH FLUID LEVEL 2 (WLT/ULT CONTACT)

#2	FLOW MODEL
#2	TRANSPORT MODEL

Calculations necessary:

- 1 Trench 1 to Franks Creek
- 2 Trench 2 to Franks Creek
- 3 Trench 8 to Franks Creek
- 4 Trenches 2, 3, 4 and 5 to Erdman Brook

RESULTS FOR GIVEN INPUTS

6.03E-07	Q	Q=na(V) = AKi, Discharge volume, m3/sec
2.13E-05	Q	Discharge volume, CF/sec
6.71E+02	Q	Discharge volume, CF/year
0.00E+00	Cl/Co	At 60 years
0.00E+00	Mass Rate	(Cl/Co) Q, CF/sec

INPUTS

1.68	Rho	soil bulk density, g/ml
1671.9	A	cross-sectional area for flow path, m2
51.2	L	minimum flow path length, m
418.2	Hi	water level in trench, at beginning of flow path, m
406.9	He	water level in creek, at end of flow path, m
5.12	A	longitudinal dispersivity = Li/10, m
2.20E-11	B	rad decay const, 1/s
0.321	Na	advective porosity
1.64E-09	Kv	hydraulic conductivity, m/s
0.0	Kd	solid/liquid partition coefficient, ml/g

Discrete input values - do not modify

UNIT CONVERSION CONSTANTS

3.15E+07	s/y
----------	-----

GENERAL COMPUTED

1.12E-09	V	water velocity, m/s $(Kv/na)/(2*(Hi/2+He/2))*(Hi*Hi-He*He)/(L)$
1	R	retardation coefficient $(1+r*ho*(1-na)*Kd/na)$ (SAIC EIS APPG 1995 EQN G-34)
1.44E+03	Tw	path travel time for water, yr $(L/v)/3.15e7$
1.44E+03	Tc	path travel time for constituent (no retardation) $yr(L/v)*R/(3.15e7)$
1.33E-09	U	$SQRT(v*v+4*b*R*a*v)$

TIME-DEPENDENT QUANTITIES COMPUTED BELOW

X1	$(v-u)*L/(2*a*v)$
X2	$(v+u)*L/(2*a*v)$
X3	$R*L-u*t$
X4	$R*L+u*t$
X5	$2*SQRT(a*v*R*t)$
X6	$ERF(X3/X5)$ Note: $erf(-x) = -erf(x)$ and $erf(x) = 2*NORMSDIST(SQRT(2)*x)-1$ (see http://support.microsoft.com/kb/893352)
X7	$ERFC(X3/X5)$ Note: $ERFC(X) = 1 - ERF(X)$
X8	$ERF(X4/X5)$ Note: $erf(-x) = -erf(x)$ and $erf(x) = 2*NORMSDIST(SQRT(2)*x)-1$ (see http://support.microsoft.com/kb/893352)
X9	$ERFC(X4/X5)$ Note: $ERFC(X) = 1 - ERF(X)$
Cl/Co	$0.5*EXP(X1)*ERFC(X3/X5)+0.5*EXP(X2)*ERFC(X4/X5)$

T, y	t, s	X1	X2	X3	X4	X5	X6	X7	X8	X9	Cl/Co
0.1	3.15E+06	-9.17E-01	1.09E+01	5.12E+01	5.12E+01	2.69E-01	1.00000	0.00000	1.00000	0.00000	0.00E+00
0.2	6.31E+06	-9.17E-01	1.09E+01	5.12E+01	5.12E+01	3.81E-01	1.00000	0.00000	1.00000	0.00000	0.00E+00
0.3	9.46E+06	-9.17E-01	1.09E+01	5.12E+01	5.12E+01	4.67E-01	1.00000	0.00000	1.00000	0.00000	0.00E+00
0.4	1.26E+07	-9.17E-01	1.09E+01	5.12E+01	5.12E+01	5.39E-01	1.00000	0.00000	1.00000	0.00000	0.00E+00
0.5	1.58E+07	-9.17E-01	1.09E+01	5.12E+01	5.12E+01	6.03E-01	1.00000	0.00000	1.00000	0.00000	0.00E+00
0.6	1.89E+07	-9.17E-01	1.09E+01	5.12E+01	5.12E+01	6.60E-01	1.00000	0.00000	1.00000	0.00000	0.00E+00
0.7	2.21E+07	-9.17E-01	1.09E+01	5.12E+01	5.12E+01	7.13E-01	1.00000	0.00000	1.00000	0.00000	0.00E+00
0.8	2.52E+07	-9.17E-01	1.09E+01	5.12E+01	5.12E+01	7.62E-01	1.00000	0.00000	1.00000	0.00000	0.00E+00
0.9	2.84E+07	-9.17E-01	1.09E+01	5.12E+01	5.12E+01	8.08E-01	1.00000	0.00000	1.00000	0.00000	0.00E+00
1	3.15E+07	-9.17E-01	1.09E+01	5.12E+01	5.12E+01	8.52E-01	1.00000	0.00000	1.00000	0.00000	0.00E+00
2	6.31E+07	-9.17E-01	1.09E+01	5.11E+01	5.13E+01	1.21E+00	1.00000	0.00000	1.00000	0.00000	0.00E+00
3	9.46E+07	-9.17E-01	1.09E+01	5.11E+01	5.13E+01	1.48E+00	1.00000	0.00000	1.00000	0.00000	0.00E+00
4	1.26E+08	-9.17E-01	1.09E+01	5.10E+01	5.14E+01	1.70E+00	1.00000	0.00000	1.00000	0.00000	0.00E+00
5	1.58E+08	-9.17E-01	1.09E+01	5.10E+01	5.14E+01	1.91E+00	1.00000	0.00000	1.00000	0.00000	0.00E+00
6	1.89E+08	-9.17E-01	1.09E+01	5.10E+01	5.15E+01	2.09E+00	1.00000	0.00000	1.00000	0.00000	0.00E+00
7	2.21E+08	-9.17E-01	1.09E+01	5.09E+01	5.15E+01	2.25E+00	1.00000	0.00000	1.00000	0.00000	0.00E+00
8	2.52E+08	-9.17E-01	1.09E+01	5.09E+01	5.15E+01	2.41E+00	1.00000	0.00000	1.00000	0.00000	0.00E+00
9	2.84E+08	-9.17E-01	1.09E+01	5.08E+01	5.16E+01	2.56E+00	1.00000	0.00000	1.00000	0.00000	0.00E+00
10	3.15E+08	-9.17E-01	1.09E+01	5.08E+01	5.16E+01	2.69E+00	1.00000	0.00000	1.00000	0.00000	0.00E+00
12	3.78E+08	-9.17E-01	1.09E+01	5.07E+01	5.17E+01	2.95E+00	1.00000	0.00000	1.00000	0.00000	0.00E+00
14	4.42E+08	-9.17E-01	1.09E+01	5.06E+01	5.18E+01	3.19E+00	1.00000	0.00000	1.00000	0.00000	0.00E+00
16	5.05E+08	-9.17E-01	1.09E+01	5.05E+01	5.19E+01	3.41E+00	1.00000	0.00000	1.00000	0.00000	0.00E+00
18	5.68E+08	-9.17E-01	1.09E+01	5.05E+01	5.20E+01	3.62E+00	1.00000	0.00000	1.00000	0.00000	0.00E+00
20	6.31E+08	-9.17E-01	1.09E+01	5.04E+01	5.20E+01	3.81E+00	1.00000	0.00000	1.00000	0.00000	0.00E+00
22	6.94E+08	-9.17E-01	1.09E+01	5.03E+01	5.21E+01	4.00E+00	1.00000	0.00000	1.00000	0.00000	0.00E+00
24	7.57E+08	-9.17E-01	1.09E+01	5.02E+01	5.22E+01	4.17E+00	1.00000	0.00000	1.00000	0.00000	0.00E+00
26	8.20E+08	-9.17E-01	1.09E+01	5.01E+01	5.23E+01	4.35E+00	1.00000	0.00000	1.00000	0.00000	0.00E+00
28	8.83E+08	-9.17E-01	1.09E+01	5.00E+01	5.24E+01	4.51E+00	1.00000	0.00000	1.00000	0.00000	0.00E+00
30	9.46E+08	-9.17E-01	1.09E+01	4.99E+01	5.25E+01	4.67E+00	1.00000	0.00000	1.00000	0.00000	0.00E+00
32	1.01E+09	-9.17E-01	1.09E+01	4.99E+01	5.25E+01	4.82E+00	1.00000	0.00000	1.00000	0.00000	0.00E+00
34	1.07E+09	-9.17E-01	1.09E+01	4.98E+01	5.26E+01	4.97E+00	1.00000	0.00000	1.00000	0.00000	0.00E+00
36	1.14E+09	-9.17E-01	1.09E+01	4.97E+01	5.27E+01	5.11E+00	1.00000	0.00000	1.00000	0.00000	0.00E+00
38	1.20E+09	-9.17E-01	1.09E+01	4.96E+01	5.28E+01	5.25E+00	1.00000	0.00000	1.00000	0.00000	0.00E+00
40	1.26E+09	-9.17E-01	1.09E+01	4.95E+01	5.29E+01	5.39E+00	1.00000	0.00000	1.00000	0.00000	0.00E+00
45	1.42E+09	-9.17E-01	1.09E+01	4.93E+01	5.31E+01	5.72E+00	1.00000	0.00000	1.00000	0.00000	0.00E+00
50	1.58E+09	-9.17E-01	1.09E+01	4.91E+01	5.33E+01	6.03E+00	1.00000	0.00000	1.00000	0.00000	0.00E+00
55	1.73E+09	-9.17E-01	1.09E+01	4.89E+01	5.35E+01	6.32E+00	1.00000	0.00000	1.00000	0.00000	0.00E+00
60	1.89E+09	-9.17E-01	1.09E+01	4.87E+01	5.37E+01	6.60E+00	1.00000	0.00000	1.00000	0.00000	0.00E+00

UNWEATHERED LAVERY TILL - HORIZONTAL FLOW - UNCONFINED CONDITION
 COMBINES FLOW FROM TRENCHES 1/2, 3, 4, & 5 FOR TRENCH FLUID LEVEL 3 (2008 LEVELS)

#2 FLOW MODEL
 #2 TRANSPORT MODEL

- Calculations necessary:
- 1 Trench 1 to Franks Creek w/ trench fluid at 2008 levels
 - 2 Trench 2 to Franks Creek w/ trench fluid at 2008 levels
 - 3 Trench 8 to Franks Creek w/ trench fluid at 2008 levels
 - 4 Trenches 2, 3, 4 and 5 to Erdman Brook w/ trench fluid at 2008 levels

RESULTS FOR GIVEN INPUTS

1.25E-05 Q Q=na(AV) = AKi, Discharge volume, m3/sec
 4.42E-04 Q Discharge volume, CF/sec
 1.39E+04 Q Discharge volume, CF/year
 9.70E-01 CL/Co At 60 years
 4.28E-04 Mass Rate (CL/Co) Q, CF/sec

INPUTS

1.68	rho	soil bulk density, g/ml
801.2	A	cross-sectional area for flow path, m2
51.2	L	minimum flow path length, m
416.2	Hi	water level in trench, at beginning of flow path, m
406.9	He	water level in creek, at end of flow path, m
5.12	a	longitudinal dispersivity = Li/10, m
2.20E-11	b	rad decay const, 1/s
0.245	na	advective porosity
8.60E-08	Kv	hydraulic conductivity, m/s
0.0	Kd	solid/liquid partition coefficient, ml/g

Discrete input values - do not modify

UNIT CONVERSION CONSTANTS

3.15E+07 s/y

GENERAL COMPUTED

6.37E-08 v water velocity, m/s $(Kv/na)/(2*(Hi/2+He/2)) * (Hi*Hi+He*He)/(L)$
 1 R retardation coefficient $(1+\rho*(1-na)*Kd/na)$ (SAIC EIS APPG 1995 EQN G-34)
 2.55E+01 Tw path travel time for water, yr $(L/v/3.15e7)$
 2.55E+01 Tc path travel time for constituent (no retardation), yr $(L/v*R/3.15e7)$
 6.39E-08 u $SQRT(v*v+4*b*R*a*v)$

TIME-DEPENDENT QUANTITIES COMPUTED BELOW

X1	$(v-u)^*L/(2*a*v)$
X2	$(v+u)^*L/(2*a*v)$
X3	R^*L-u*t
X4	R^*L+u*t
X5	$2*SQRT(a*v*R*t)$
X6	ERF(X3/X5) Note: erf(-x) = -erf(x) and erf(x) = 2*NORMSDIST(SQRT(2)*x)-1 (see http://support.microsoft.com/kb/893352)
X7	ERFC(X3/X5) Note: ERFC(X) = 1 - ERF(X)
X8	ERF(X4/X5) Note: erf(-x) = -erf(x) and erf(x) = 2*NORMSDIST(SQRT(2)*x)-1 (see http://support.microsoft.com/kb/893352)
X9	ERFC(X4/X5) Note: ERFC(X) = 1 - ERF(X)
Cl/Co	$0.5*EXP(X1)*ERFC(X3/X5)+0.5*EXP(X2)*ERFC(X4/X5)$

T, Y	t, s	X1	X2	X3	X4	X5	X6	X7	X8	X9	Cl/Co
0.1	3.15E+06	-1.76E-02	1.00E+01	5.10E+01	5.14E+01	2.03E+00	1.00000	0.00000	1.00000	0.00000	0.00E+00
0.2	6.31E+06	-1.76E-02	1.00E+01	5.08E+01	5.16E+01	2.87E+00	1.00000	0.00000	1.00000	0.00000	0.00E+00
0.3	9.46E+06	-1.76E-02	1.00E+01	5.06E+01	5.18E+01	3.51E+00	1.00000	0.00000	1.00000	0.00000	0.00E+00
0.4	1.26E+07	-1.76E-02	1.00E+01	5.04E+01	5.20E+01	4.06E+00	1.00000	0.00000	1.00000	0.00000	0.00E+00
0.5	1.58E+07	-1.76E-02	1.00E+01	5.02E+01	5.22E+01	4.54E+00	1.00000	0.00000	1.00000	0.00000	0.00E+00
0.6	1.89E+07	-1.76E-02	1.00E+01	5.00E+01	5.24E+01	4.97E+00	1.00000	0.00000	1.00000	0.00000	0.00E+00
0.7	2.21E+07	-1.76E-02	1.00E+01	4.98E+01	5.26E+01	5.37E+00	1.00000	0.00000	1.00000	0.00000	0.00E+00
0.8	2.52E+07	-1.76E-02	1.00E+01	4.96E+01	5.28E+01	5.74E+00	1.00000	0.00000	1.00000	0.00000	0.00E+00
0.9	2.84E+07	-1.76E-02	1.00E+01	4.94E+01	5.30E+01	6.09E+00	1.00000	0.00000	1.00000	0.00000	0.00E+00
1	3.15E+07	-1.76E-02	1.00E+01	4.92E+01	5.32E+01	6.42E+00	1.00000	0.00000	1.00000	0.00000	0.00E+00
2	6.31E+07	-1.76E-02	1.00E+01	4.72E+01	5.52E+01	9.07E+00	1.00000	0.00000	1.00000	0.00000	9.48E-14
3	9.46E+07	-1.76E-02	1.00E+01	4.52E+01	5.73E+01	1.11E+01	1.00000	0.00000	1.00000	0.00000	7.99E-09
4	1.26E+08	-1.76E-02	1.00E+01	4.31E+01	5.93E+01	1.28E+01	1.00000	0.00000	1.00000	0.00000	1.69E-06
5	1.58E+08	-1.76E-02	1.00E+01	4.11E+01	6.13E+01	1.43E+01	0.99995	0.00005	1.00000	0.00000	4.17E-05
6	1.89E+08	-1.76E-02	1.00E+01	3.91E+01	6.33E+01	1.57E+01	0.99957	0.00043	1.00000	0.00000	3.49E-04
7	2.21E+08	-1.76E-02	1.00E+01	3.71E+01	6.53E+01	1.70E+01	0.99800	0.00200	1.00000	0.00000	1.57E-03
8	2.52E+08	-1.76E-02	1.00E+01	3.51E+01	6.73E+01	1.81E+01	0.99374	0.00626	1.00000	0.00000	4.79E-03
9	2.84E+08	-1.76E-02	1.00E+01	3.31E+01	6.94E+01	1.92E+01	0.98488	0.01512	1.00000	0.00000	1.13E-02
10	3.15E+08	-1.76E-02	1.00E+01	3.10E+01	7.14E+01	2.03E+01	0.96955	0.03045	1.00000	0.00000	2.23E-02
12	3.78E+08	-1.76E-02	1.00E+01	2.70E+01	7.54E+01	2.22E+01	0.91439	0.08561	1.00000	0.00000	6.00E-02
14	4.42E+08	-1.76E-02	1.00E+01	2.30E+01	7.94E+01	2.40E+01	0.82423	0.17577	1.00000	0.00000	1.18E-01
16	5.05E+08	-1.76E-02	1.00E+01	1.89E+01	8.35E+01	2.57E+01	0.70361	0.29639	1.00000	0.00000	1.93E-01
18	5.68E+08	-1.76E-02	1.00E+01	1.49E+01	8.75E+01	2.72E+01	0.56163	0.43837	0.99999	0.00001	2.76E-01
20	6.31E+08	-1.76E-02	1.00E+01	1.09E+01	9.15E+01	2.87E+01	0.40832	0.59168	0.99999	0.00001	3.63E-01
22	6.94E+08	-1.76E-02	1.00E+01	6.85E+00	9.56E+01	3.01E+01	0.25248	0.74752	0.99999	0.00001	4.46E-01
24	7.57E+08	-1.76E-02	1.00E+01	2.82E+00	9.96E+01	3.14E+01	0.10086	0.89914	0.99999	0.00001	5.25E-01
26	8.20E+08	-1.76E-02	1.00E+01	-1.22E+00	1.04E+02	3.27E+01	-0.04192	1.04192	0.99999	0.00001	5.95E-01
28	8.83E+08	-1.76E-02	1.00E+01	-5.25E+00	1.08E+02	3.39E+01	-0.17308	1.17308	0.99999	0.00001	6.58E-01
30	9.46E+08	-1.76E-02	1.00E+01	-9.28E+00	1.12E+02	3.51E+01	-0.29125	1.29125	0.99999	0.00001	7.12E-01
32	1.01E+09	-1.76E-02	1.00E+01	-1.33E+01	1.16E+02	3.63E+01	-0.39612	1.39612	0.99999	0.00001	7.59E-01
34	1.07E+09	-1.76E-02	1.00E+01	-1.73E+01	1.20E+02	3.74E+01	-0.48804	1.48804	0.99999	0.00001	7.98E-01
36	1.14E+09	-1.76E-02	1.00E+01	-2.14E+01	1.24E+02	3.85E+01	-0.56783	1.56783	0.99999	0.00001	8.31E-01
38	1.20E+09	-1.76E-02	1.00E+01	-2.54E+01	1.28E+02	3.95E+01	-0.63651	1.63651	1.00000	0.00000	8.58E-01
40	1.26E+09	-1.76E-02	1.00E+01	-2.94E+01	1.32E+02	4.06E+01	-0.69525	1.69525	1.00000	0.00000	8.81E-01
45	1.42E+09	-1.76E-02	1.00E+01	-3.95E+01	1.42E+02	4.30E+01	-0.80602	1.80602	1.00000	0.00000	9.22E-01
50	1.58E+09	-1.76E-02	1.00E+01	-4.96E+01	1.52E+02	4.54E+01	-0.87803	1.87803	1.00000	0.00000	9.47E-01
55	1.73E+09	-1.76E-02	1.00E+01	-5.97E+01	1.62E+02	4.76E+01	-0.92398	1.92398	1.00000	0.00000	9.61E-01
60	1.89E+09	-1.76E-02	1.00E+01	-6.98E+01	1.72E+02	4.97E+01	-0.95292	1.95292	1.00000	0.00000	9.70E-01

UNWEATHERED LAVERY TILL - HORIZONTAL FLOW - CONFINED CONDITION
 COMBINES FLOW FROM TRENCHES 1/2, 8, 3, 4, & 5 FOR TRENCH FLUID LEVEL 1 (TOP OF TRENCH)

#3 FLOW MODEL
 #2 TRANSPORT MODEL

Calculations necessary:

- | | | |
|---|---|---|
| 1 | Trench 1 to Franks Creek in ULT | w/ trench fluid at highest level (trench top) |
| 2 | Trench 2 to Franks Creek in ULT | w/ trench fluid at highest level (trench top) |
| 3 | Trench 8 to Franks Creek in ULT | w/ trench fluid at highest level (trench top) |
| 4 | Trenches 2, 3, 4 and 5 to Erdman Brook in ULT | w/ trench fluid at highest level (trench top) |

RESULTS FOR GIVEN INPUTS

7.82E-07	Q	$Q=na(AV) = AK_i$, Discharge volume, m ³ /sec
2.76E-05	Q	Discharge volume, CF/sec
8.71E+02	Q	Discharge volume, CF/year
0.00E+00	Cl/Co	At 60 years
0.00E+00	Mass Rate	(Cl/Co) Q, CF/sec

INPUTS

1.68	rho	soil bulk density, g/ml
1671.9	A	cross-sectional area for flow path, m ²
51.2	L	minimum flow path length, m
421.5	Hi	water level in trench, at beginning of flow path, m
406.9	He	water level in creek, at end of flow path, m
5.12	a	longitudinal dispersivity = Li/10, m
2.20E-11	b	rad decay const, 1/s
0.321	na	advective porosity
1.64E-09	Kv	hydraulic conductivity, m/s
0.0	Kd	solid/liquid partition coefficient, ml/g

Discrete input values - do not modify

UNIT CONVERSION CONSTANTS

3.15E+07 s/y

GENERAL COMPUTED

1.46E-09	v	water velocity, m/s ($Kv*(Hi-He)/(na*L)$)
1	R	retardation coefficient ($1+\rho*(1-na)*Kd/na$) (SAIC EIS APPG 1995 EQN G-34)
1.11E+03	Tw	path travel time for water, yr ($L/v/3.15e7$)
1.11E+03	Tc	path travel time for constituent (no retardation), yr ($L/v*R/3.15e7$)
1.67E-09	u	$SQRT(v*v+4*b*R*a*v)$

TIME-DEPENDENT QUANTITIES COMPUTED BELOW

X1	$(v-u)^*L/(2^*a^*v)$
X2	$(v+u)^*L/(2^*a^*v)$
X3	R^*L-u^*t
X4	R^*L+u^*t
X5	$2^*SQRT(a^*v^*R^*t)$
X6	$ERF(X3/X5)$ Note: $erf(-x) = -erf(x)$ and $erf(x) = 2^*NORMSDIST(SQRT(2)^*x)-1$ (see http://support.microsoft.com/kb/893352)
X7	$ERFC(X3/X5)$ Note: $ERFC(X) = 1 - ERF(X)$
X8	$ERF(X4/X5)$ Note: $erf(-x) = -erf(x)$ and $erf(x) = 2^*NORMSDIST(SQRT(2)^*x)-1$ (see http://support.microsoft.com/kb/893352)
X9	$ERFC(X4/X5)$ Note: $ERFC(X) = 1 - ERF(X)$
CL/Co	$0.5^*EXP(X1)^*ERFC(X3/X5)+0.5^*EXP(X2)^*ERFC(X4/X5)$

T, y	t, s	X1	X2	X3	X4	X5	X6	X7	X8	X9	Cl/Co
0.1	3.15E+06	-7.20E-01	1.07E+01	5.12E+01	5.12E+01	3.07E-01	1.00000	0.00000	1.00000	0.00000	0.00E+00
0.2	6.31E+06	-7.20E-01	1.07E+01	5.12E+01	5.12E+01	4.34E-01	1.00000	0.00000	1.00000	0.00000	0.00E+00
0.3	9.46E+06	-7.20E-01	1.07E+01	5.12E+01	5.12E+01	5.32E-01	1.00000	0.00000	1.00000	0.00000	0.00E+00
0.4	1.26E+07	-7.20E-01	1.07E+01	5.12E+01	5.12E+01	6.14E-01	1.00000	0.00000	1.00000	0.00000	0.00E+00
0.5	1.58E+07	-7.20E-01	1.07E+01	5.12E+01	5.12E+01	6.86E-01	1.00000	0.00000	1.00000	0.00000	0.00E+00
0.6	1.89E+07	-7.20E-01	1.07E+01	5.12E+01	5.12E+01	7.52E-01	1.00000	0.00000	1.00000	0.00000	0.00E+00
0.7	2.21E+07	-7.20E-01	1.07E+01	5.12E+01	5.12E+01	8.12E-01	1.00000	0.00000	1.00000	0.00000	0.00E+00
0.8	2.52E+07	-7.20E-01	1.07E+01	5.12E+01	5.12E+01	8.68E-01	1.00000	0.00000	1.00000	0.00000	0.00E+00
0.9	2.84E+07	-7.20E-01	1.07E+01	5.12E+01	5.13E+01	9.21E-01	1.00000	0.00000	1.00000	0.00000	0.00E+00
1	3.15E+07	-7.20E-01	1.07E+01	5.12E+01	5.13E+01	9.71E-01	1.00000	0.00000	1.00000	0.00000	0.00E+00
2	6.31E+07	-7.20E-01	1.07E+01	5.11E+01	5.13E+01	1.37E+00	1.00000	0.00000	1.00000	0.00000	0.00E+00
3	9.46E+07	-7.20E-01	1.07E+01	5.10E+01	5.14E+01	1.68E+00	1.00000	0.00000	1.00000	0.00000	0.00E+00
4	1.26E+08	-7.20E-01	1.07E+01	5.10E+01	5.14E+01	1.94E+00	1.00000	0.00000	1.00000	0.00000	0.00E+00
5	1.58E+08	-7.20E-01	1.07E+01	5.09E+01	5.15E+01	2.17E+00	1.00000	0.00000	1.00000	0.00000	0.00E+00
6	1.89E+08	-7.20E-01	1.07E+01	5.09E+01	5.15E+01	2.38E+00	1.00000	0.00000	1.00000	0.00000	0.00E+00
7	2.21E+08	-7.20E-01	1.07E+01	5.08E+01	5.16E+01	2.57E+00	1.00000	0.00000	1.00000	0.00000	0.00E+00
8	2.52E+08	-7.20E-01	1.07E+01	5.08E+01	5.16E+01	2.75E+00	1.00000	0.00000	1.00000	0.00000	0.00E+00
9	2.84E+08	-7.20E-01	1.07E+01	5.07E+01	5.17E+01	2.91E+00	1.00000	0.00000	1.00000	0.00000	0.00E+00
10	3.15E+08	-7.20E-01	1.07E+01	5.07E+01	5.17E+01	3.07E+00	1.00000	0.00000	1.00000	0.00000	0.00E+00
12	3.78E+08	-7.20E-01	1.07E+01	5.06E+01	5.18E+01	3.36E+00	1.00000	0.00000	1.00000	0.00000	0.00E+00
14	4.42E+08	-7.20E-01	1.07E+01	5.05E+01	5.19E+01	3.63E+00	1.00000	0.00000	1.00000	0.00000	0.00E+00
16	5.05E+08	-7.20E-01	1.07E+01	5.04E+01	5.20E+01	3.88E+00	1.00000	0.00000	1.00000	0.00000	0.00E+00
18	5.68E+08	-7.20E-01	1.07E+01	5.03E+01	5.22E+01	4.12E+00	1.00000	0.00000	1.00000	0.00000	0.00E+00
20	6.31E+08	-7.20E-01	1.07E+01	5.02E+01	5.23E+01	4.34E+00	1.00000	0.00000	1.00000	0.00000	0.00E+00
22	6.94E+08	-7.20E-01	1.07E+01	5.00E+01	5.24E+01	4.55E+00	1.00000	0.00000	1.00000	0.00000	0.00E+00
24	7.57E+08	-7.20E-01	1.07E+01	4.99E+01	5.25E+01	4.76E+00	1.00000	0.00000	1.00000	0.00000	0.00E+00
26	8.20E+08	-7.20E-01	1.07E+01	4.98E+01	5.26E+01	4.95E+00	1.00000	0.00000	1.00000	0.00000	0.00E+00
28	8.83E+08	-7.20E-01	1.07E+01	4.97E+01	5.27E+01	5.14E+00	1.00000	0.00000	1.00000	0.00000	0.00E+00
30	9.46E+08	-7.20E-01	1.07E+01	4.96E+01	5.28E+01	5.32E+00	1.00000	0.00000	1.00000	0.00000	0.00E+00
32	1.01E+09	-7.20E-01	1.07E+01	4.95E+01	5.29E+01	5.49E+00	1.00000	0.00000	1.00000	0.00000	0.00E+00
34	1.07E+09	-7.20E-01	1.07E+01	4.94E+01	5.30E+01	5.66E+00	1.00000	0.00000	1.00000	0.00000	0.00E+00
36	1.14E+09	-7.20E-01	1.07E+01	4.93E+01	5.31E+01	5.82E+00	1.00000	0.00000	1.00000	0.00000	0.00E+00
38	1.20E+09	-7.20E-01	1.07E+01	4.92E+01	5.32E+01	5.98E+00	1.00000	0.00000	1.00000	0.00000	0.00E+00
40	1.26E+09	-7.20E-01	1.07E+01	4.91E+01	5.33E+01	6.14E+00	1.00000	0.00000	1.00000	0.00000	0.00E+00
45	1.42E+09	-7.20E-01	1.07E+01	4.88E+01	5.36E+01	6.51E+00	1.00000	0.00000	1.00000	0.00000	0.00E+00
50	1.58E+09	-7.20E-01	1.07E+01	4.86E+01	5.38E+01	6.86E+00	1.00000	0.00000	1.00000	0.00000	0.00E+00
55	1.73E+09	-7.20E-01	1.07E+01	4.83E+01	5.41E+01	7.20E+00	1.00000	0.00000	1.00000	0.00000	0.00E+00
60	1.89E+09	-7.20E-01	1.07E+01	4.80E+01	5.44E+01	7.52E+00	1.00000	0.00000	1.00000	0.00000	0.00E+00

UNWEATHERED LAVERY TILL - VERTICAL FLOW FROM 12 OF 14 TRENCHES WITH $i = 1.0$
 FLOW FROM SDA TRENCHES 21 METERS VERTICALLY TO THE TOP OF THE KRS

#4 FLOW MODEL
 #3 TRANSPORT MODEL

Calculations necessary

- 1 Flow from 12 of 14 trenches to KRS, fluid level in trenches not considered for $i = 1.0$

RESULTS FOR GIVEN INPUTS

4.26E-05	Q	$Q = na(AV) = AKi$, Discharge volume, m ³ /sec
1.50E-03	Q	Discharge volume, CF/sec
4.74E+04	Q	Discharge volume, CF/year
6.92E-01	CL/Co	At 60 years
1.04E-03	Mass Rate	(CL/Co) Q, CF/sec

INPUTS

1.68	rho	soil bulk density, g/ml
12769.4	A	cross-sectional area for flow path, m ²
21.0	L	minimum flow path length, m
NA	Hi	water level in trench, at beginning of flow path, m
NA	He	water level in creek, at end of flow path, m
2.10	a	longitudinal dispersivity = $L_i/10$, m
2.20E-11	b	rad decay const, 1/s
0.259	na	advective porosity
3.34E-09	Kv	hydraulic conductivity, m/s
0.0	Kd	solid/liquid partition coefficient, ml/g

Discrete input values - do not modify

UNIT CONVERSION CONSTANTS

3.15E+07	s/yr
----------	------

GENERAL COMPUTED

1.29E-08	v	water velocity, m/s, $v = (Kv * 1)/(na)$
1	R	retardation coefficient $(1 + rho * (1 - na) * Kd/na)$ (SAIC EIS APPG 1995 EQN G-34)
5.17E+01	Tw	path travel time for water, yr $(L/v/3.15e7)$
5.17E+01	Tc	path travel time for constituent (no retardation), yr $(L/v * R/3.15e7)$
1.30E-08	u	$SORT(v * v + 4 * b * R * a * v)$

TIME-DEPENDENT QUANTITIES COMPUTED BELOW

X1	$(v-u)^*L/(2^*a^*v)$
X2	$(v+u)^*L/(2^*a^*v)$
X3	R^*L-u^*t
X4	R^*L+u^*t
X5	$2^*SQRT(a^*v^*R^*t)$
X6	$ERF(X3/X5)$ Note: $erf(-x) = -erf(x)$ and $erf(x) = 2^*NORMSDIST(SQRT(2)^*x)-1$ (see http://support.microsoft.com/kb/893352)
X7	$ERFC(X3/X5)$ Note: $ERFC(X) = 1 - ERF(X)$
X8	$ERF(X4/X5)$ Note: $erf(-x) = -erf(x)$ and $erf(x) = 2^*NORMSDIST(SQRT(2)^*x)-1$ (see http://support.microsoft.com/kb/893352)
X9	$ERFC(X4/X5)$ Note: $ERFC(X) = 1 - ERF(X)$
CL/Co	$0.5^*EXP(X1)^*ERFC(X3/X5)+0.5^*EXP(X2)^*ERFC(X4/X5)$

T, Y	t, s	X1	X2	X3	X4	X5	X6	X7	X8	X9	Cl/Co
0.1	3.15E+06	-3.57E-02	1.00E+01	2.10E+01	2.10E+01	5.84E-01	1.00000	0.00000	1.00000	0.00000	0.00E+00
0.2	6.31E+06	-3.57E-02	1.00E+01	2.09E+01	2.11E+01	8.26E-01	1.00000	0.00000	1.00000	0.00000	0.00E+00
0.3	9.46E+06	-3.57E-02	1.00E+01	2.09E+01	2.11E+01	1.01E+00	1.00000	0.00000	1.00000	0.00000	0.00E+00
0.4	1.26E+07	-3.57E-02	1.00E+01	2.08E+01	2.12E+01	1.17E+00	1.00000	0.00000	1.00000	0.00000	0.00E+00
0.5	1.58E+07	-3.57E-02	1.00E+01	2.08E+01	2.12E+01	1.31E+00	1.00000	0.00000	1.00000	0.00000	0.00E+00
0.6	1.89E+07	-3.57E-02	1.00E+01	2.08E+01	2.12E+01	1.43E+00	1.00000	0.00000	1.00000	0.00000	0.00E+00
0.7	2.21E+07	-3.57E-02	1.00E+01	2.07E+01	2.13E+01	1.55E+00	1.00000	0.00000	1.00000	0.00000	0.00E+00
0.8	2.52E+07	-3.57E-02	1.00E+01	2.07E+01	2.13E+01	1.65E+00	1.00000	0.00000	1.00000	0.00000	0.00E+00
0.9	2.84E+07	-3.57E-02	1.00E+01	2.06E+01	2.14E+01	1.75E+00	1.00000	0.00000	1.00000	0.00000	0.00E+00
1	3.15E+07	-3.57E-02	1.00E+01	2.06E+01	2.14E+01	1.85E+00	1.00000	0.00000	1.00000	0.00000	0.00E+00
2	6.31E+07	-3.57E-02	1.00E+01	2.02E+01	2.18E+01	2.61E+00	1.00000	0.00000	1.00000	0.00000	0.00E+00
3	9.46E+07	-3.57E-02	1.00E+01	1.98E+01	2.22E+01	3.20E+00	1.00000	0.00000	1.00000	0.00000	0.00E+00
4	1.26E+08	-3.57E-02	1.00E+01	1.94E+01	2.26E+01	3.69E+00	1.00000	0.00000	1.00000	0.00000	5.97E-14
5	1.58E+08	-3.57E-02	1.00E+01	1.90E+01	2.30E+01	4.13E+00	1.00000	0.00000	1.00000	0.00000	7.68E-11
6	1.89E+08	-3.57E-02	1.00E+01	1.85E+01	2.35E+01	4.52E+00	1.00000	0.00000	1.00000	0.00000	5.86E-09
7	2.21E+08	-3.57E-02	1.00E+01	1.81E+01	2.39E+01	4.89E+00	1.00000	0.00000	1.00000	0.00000	1.31E-07
8	2.52E+08	-3.57E-02	1.00E+01	1.77E+01	2.43E+01	5.22E+00	1.00000	0.00000	1.00000	0.00000	1.34E-06
9	2.84E+08	-3.57E-02	1.00E+01	1.73E+01	2.47E+01	5.54E+00	0.99999	0.00001	1.00000	0.00000	8.18E-06
10	3.15E+08	-3.57E-02	1.00E+01	1.69E+01	2.51E+01	5.84E+00	0.99996	0.00004	1.00000	0.00000	3.46E-05
12	3.78E+08	-3.57E-02	1.00E+01	1.61E+01	2.59E+01	6.40E+00	0.99962	0.00038	1.00000	0.00000	2.98E-04
14	4.42E+08	-3.57E-02	1.00E+01	1.53E+01	2.67E+01	6.91E+00	0.99822	0.00178	1.00000	0.00000	1.37E-03
16	5.05E+08	-3.57E-02	1.00E+01	1.45E+01	2.75E+01	7.39E+00	0.99434	0.00566	1.00000	0.00000	4.27E-03
18	5.68E+08	-3.57E-02	1.00E+01	1.36E+01	2.84E+01	7.84E+00	0.98614	0.01386	1.00000	0.00000	1.02E-02
20	6.31E+08	-3.57E-02	1.00E+01	1.28E+01	2.92E+01	8.26E+00	0.97181	0.02819	1.00000	0.00000	2.03E-02
22	6.94E+08	-3.57E-02	1.00E+01	1.20E+01	3.00E+01	8.66E+00	0.94988	0.05012	1.00000	0.00000	3.53E-02
24	7.57E+08	-3.57E-02	1.00E+01	1.12E+01	3.08E+01	9.05E+00	0.91948	0.08052	1.00000	0.00000	5.55E-02
26	8.20E+08	-3.57E-02	1.00E+01	1.04E+01	3.16E+01	9.42E+00	0.88036	0.11964	1.00000	0.00000	8.09E-02
28	8.83E+08	-3.57E-02	1.00E+01	9.55E+00	3.25E+01	9.77E+00	0.83281	0.16719	1.00000	0.00000	1.11E-01
30	9.46E+08	-3.57E-02	1.00E+01	8.73E+00	3.33E+01	1.01E+01	0.77757	0.22243	1.00000	0.00000	1.45E-01
32	1.01E+09	-3.57E-02	1.00E+01	7.91E+00	3.41E+01	1.04E+01	0.71565	0.28435	1.00000	0.00000	1.82E-01
34	1.07E+09	-3.57E-02	1.00E+01	7.09E+00	3.49E+01	1.08E+01	0.64826	0.35174	1.00000	0.00000	2.22E-01
36	1.14E+09	-3.57E-02	1.00E+01	6.27E+00	3.57E+01	1.11E+01	0.57663	0.42337	0.99999	0.00001	2.63E-01
38	1.20E+09	-3.57E-02	1.00E+01	5.46E+00	3.65E+01	1.14E+01	0.50199	0.49801	0.99999	0.00001	3.05E-01
40	1.26E+09	-3.57E-02	1.00E+01	4.64E+00	3.74E+01	1.17E+01	0.42549	0.57451	0.99999	0.00001	3.47E-01
45	1.42E+09	-3.57E-02	1.00E+01	2.59E+00	3.94E+01	1.24E+01	0.23267	0.76733	0.99999	0.00001	4.49E-01
50	1.58E+09	-3.57E-02	1.00E+01	5.47E-01	4.15E+01	1.31E+01	0.04723	0.95277	0.99999	0.00001	5.42E-01
55	1.73E+09	-3.57E-02	1.00E+01	-1.50E+00	4.35E+01	1.37E+01	-0.12293	1.12293	0.99999	0.00001	6.23E-01
60	1.89E+09	-3.57E-02	1.00E+01	-3.54E+00	4.55E+01	1.43E+01	-0.27386	1.27386	0.99999	0.00001	6.92E-01

KENT RECESSIONAL SEQUENCE - HORIZONTAL FLOW - UNCONFINED AQUIFER CONDITION
 FLOW FROM POINT DIRECTLY BENEATH SDA TRENCHES TO BUTTERMILK CREEK

#5 FLOW MODEL
 #4 TRANSPORT MODEL

Calculations necessary

- 1 Flow from all trenches (FM #4) to KRS, one fluid level, Hi is groundwater level in KRS beneath trenches, He is elev of base of KRS in Buttermilk Ck valley wall

RESULTS FOR GIVEN INPUTS

4.31E-05	Q	$Q=na(AV) = AK_i$, Discharge volume, m3/sec
1.52E-03	Q	Discharge volume, CF/sec
4.80E+04	Q	Discharge volume, CF/year
1.05E-05	CL/Co	At 60 years (temp reset to 30 Y)
1.60E-08	Mass Rate	(CL/Co) Q, CF/sec

INPUTS

1.92	rho	soil bulk density, g/ml
2133.6	A	cross-sectional area for flow path, m2
906.8	L	minimum flow path length, m
390.1	Hi	water level in trench, at beginning of flow path, m
384.0	He	water level in creek, at end of flow path, m
90.7	a	longitudinal dispersivity = Li/10, m
2.20E-11	b	rad decay const, 1/s
0.237	na	advective porosity
3.00E-06	Kh	hydraulic conductivity, m/s
0.0	Kd	solid/liquid partition coefficient, ml/g

Discrete input values - do not modify

UNIT CONVERSION CONSTANTS

3.15E+07 sec/yr

GENERAL COMPUTED

8.51E-08	v	water velocity, m/s $(Kv/na)/(C^2*(Hi/2+He/2))*(Hi*Hi-He*He)/(L)$
1	R	retardation coefficient $(1+rho*(1-na)*Kd/na)$ (SAIC EIS APPG 1995 EQN G-34)
3.38E+02	Tw	path travel time for water, yr $(L/v/3.15e7)$
3.38E+02	Tc	path travel time for constituent (no retardation), yr $(L/v*R/3.15e7)$
8.90E-08	u	$SQRT(v*v+4*b*R*a*v)$

TIME-DEPENDENT QUANTITIES COMPUTED BELOW

X1	$(v-u)*L/(2*a*v)$
X2	$(v+u)*L/(2*a*v)$
X3	$R*L-u*t$
X4	$R*L+u*t$
X5	$2*SQRT(a*v*R*t)$
X6	$ERF(X3/X5)$ Note: $erf(-x) = -erf(x)$ and $erf(x) = 2*NORMSDIST(SQRT(2)*x)-1$ (see http://support.microsoft.com/kb/893352)
X7	$ERFC(X3/X5)$ Note: $ERFC(X) = 1 - ERF(X)$
X8	$ERF(X4/X5)$ Note: $erf(-x) = -erf(x)$ and $erf(x) = 2*NORMSDIST(SQRT(2)*x)-1$ (see http://support.microsoft.com/kb/893352)
X9	$ERFC(X4/X5)$ Note: $ERFC(X) = 1 - ERF(X)$
Cl/Co	$0.5*EXP(X1)*ERFC(X3/X5)+0.5*EXP(X2)*ERFC(X4/X5)$

T, Y	t, s	X1	X2	X3	X4	X5	X6	X7	X8	X9	Cl/Co
0.1	3.15E+06	-2.29E-01	1.02E+01	9.06E+02	9.07E+02	9.87E+00	1.00000	0.00000	1.00000	0.00000	0.00E+00
0.2	6.31E+06	-2.29E-01	1.02E+01	9.06E+02	9.07E+02	1.40E+01	1.00000	0.00000	1.00000	0.00000	0.00E+00
0.3	9.46E+06	-2.29E-01	1.02E+01	9.06E+02	9.08E+02	1.71E+01	1.00000	0.00000	1.00000	0.00000	0.00E+00
0.4	1.26E+07	-2.29E-01	1.02E+01	9.06E+02	9.08E+02	1.97E+01	1.00000	0.00000	1.00000	0.00000	0.00E+00
0.5	1.58E+07	-2.29E-01	1.02E+01	9.05E+02	9.08E+02	2.21E+01	1.00000	0.00000	1.00000	0.00000	0.00E+00
0.6	1.89E+07	-2.29E-01	1.02E+01	9.05E+02	9.08E+02	2.42E+01	1.00000	0.00000	1.00000	0.00000	0.00E+00
0.7	2.21E+07	-2.29E-01	1.02E+01	9.05E+02	9.09E+02	2.61E+01	1.00000	0.00000	1.00000	0.00000	0.00E+00
0.8	2.52E+07	-2.29E-01	1.02E+01	9.05E+02	9.09E+02	2.79E+01	1.00000	0.00000	1.00000	0.00000	0.00E+00
0.9	2.84E+07	-2.29E-01	1.02E+01	9.04E+02	9.09E+02	2.96E+01	1.00000	0.00000	1.00000	0.00000	0.00E+00
1	3.15E+07	-2.29E-01	1.02E+01	9.04E+02	9.10E+02	3.12E+01	1.00000	0.00000	1.00000	0.00000	0.00E+00
2	6.31E+07	-2.29E-01	1.02E+01	9.01E+02	9.12E+02	4.41E+01	1.00000	0.00000	1.00000	0.00000	0.00E+00
3	9.46E+07	-2.29E-01	1.02E+01	8.98E+02	9.15E+02	5.40E+01	1.00000	0.00000	1.00000	0.00000	0.00E+00
4	1.26E+08	-2.29E-01	1.02E+01	8.96E+02	9.18E+02	6.24E+01	1.00000	0.00000	1.00000	0.00000	0.00E+00
5	1.58E+08	-2.29E-01	1.02E+01	8.93E+02	9.21E+02	6.98E+01	1.00000	0.00000	1.00000	0.00000	0.00E+00
6	1.89E+08	-2.29E-01	1.02E+01	8.90E+02	9.24E+02	7.64E+01	1.00000	0.00000	1.00000	0.00000	0.00E+00
7	2.21E+08	-2.29E-01	1.02E+01	8.87E+02	9.26E+02	8.25E+01	1.00000	0.00000	1.00000	0.00000	0.00E+00
8	2.52E+08	-2.29E-01	1.02E+01	8.84E+02	9.29E+02	8.82E+01	1.00000	0.00000	1.00000	0.00000	0.00E+00
9	2.84E+08	-2.29E-01	1.02E+01	8.82E+02	9.32E+02	9.36E+01	1.00000	0.00000	1.00000	0.00000	0.00E+00
10	3.15E+08	-2.29E-01	1.02E+01	8.79E+02	9.35E+02	9.87E+01	1.00000	0.00000	1.00000	0.00000	0.00E+00
12	3.78E+08	-2.29E-01	1.02E+01	8.73E+02	9.40E+02	1.08E+02	1.00000	0.00000	1.00000	0.00000	0.00E+00
14	4.42E+08	-2.29E-01	1.02E+01	8.67E+02	9.46E+02	1.17E+02	1.00000	0.00000	1.00000	0.00000	0.00E+00
16	5.05E+08	-2.29E-01	1.02E+01	8.62E+02	9.52E+02	1.25E+02	1.00000	0.00000	1.00000	0.00000	0.00E+00
18	5.68E+08	-2.29E-01	1.02E+01	8.56E+02	9.57E+02	1.32E+02	1.00000	0.00000	1.00000	0.00000	0.00E+00
20	6.31E+08	-2.29E-01	1.02E+01	8.51E+02	9.63E+02	1.40E+02	1.00000	0.00000	1.00000	0.00000	0.00E+00
22	6.94E+08	-2.29E-01	1.02E+01	8.45E+02	9.69E+02	1.46E+02	1.00000	0.00000	1.00000	0.00000	0.00E+00
24	7.57E+08	-2.29E-01	1.02E+01	8.39E+02	9.74E+02	1.53E+02	1.00000	0.00000	1.00000	0.00000	3.18E-15
26	8.20E+08	-2.29E-01	1.02E+01	8.34E+02	9.80E+02	1.59E+02	1.00000	0.00000	1.00000	0.00000	4.91E-14
28	8.83E+08	-2.29E-01	1.02E+01	8.28E+02	9.85E+02	1.65E+02	1.00000	0.00000	1.00000	0.00000	5.13E-13
30	9.46E+08	-2.29E-01	1.02E+01	8.23E+02	9.91E+02	1.71E+02	1.00000	0.00000	1.00000	0.00000	3.93E-12
32	1.01E+09	-2.29E-01	1.02E+01	8.17E+02	9.97E+02	1.76E+02	1.00000	0.00000	1.00000	0.00000	2.33E-11
34	1.07E+09	-2.29E-01	1.02E+01	8.11E+02	1.00E+03	1.82E+02	1.00000	0.00000	1.00000	0.00000	2.05E-10
36	1.14E+09	-2.29E-01	1.02E+01	8.06E+02	1.01E+03	1.87E+02	1.00000	0.00000	1.00000	0.00000	8.21E-10
38	1.20E+09	-2.29E-01	1.02E+01	8.00E+02	1.01E+03	1.92E+02	1.00000	0.00000	1.00000	0.00000	2.86E-09
40	1.26E+09	-2.29E-01	1.02E+01	7.95E+02	1.02E+03	1.97E+02	1.00000	0.00000	1.00000	0.00000	8.77E-09
45	1.42E+09	-2.29E-01	1.02E+01	7.81E+02	1.03E+03	2.09E+02	1.00000	0.00000	1.00000	0.00000	9.35E-08
50	1.58E+09	-2.29E-01	1.02E+01	7.66E+02	1.05E+03	2.21E+02	1.00000	0.00000	1.00000	0.00000	6.19E-07
55	1.73E+09	-2.29E-01	1.02E+01	7.52E+02	1.06E+03	2.31E+02	1.00000	0.00000	1.00000	0.00000	2.90E-06
60	1.89E+09	-2.29E-01	1.02E+01	7.38E+02	1.08E+03	2.42E+02	0.99998	0.00002	1.00000	0.00000	1.05E-05

APPENDIX 6.5B

UNCERTAINTIES IN WATER FLOW FROM TRENCHES

Supplementary discussion of considerations in quantifying uncertainties in groundwater flow is provided in this appendix.

Assuming hydraulic gradients, flowpath lengths, and discharge cross-sectional areas that are fixed by site characteristics and are known fairly accurately and precisely, the remaining parameters important in determining trench water discharge rate and path travel time are hydraulic conductivity and porosity. These parameters are not known accurately or precisely. Consequently, they are treated probabilistically. The trench water release rate through a flowpath is directly proportional to the hydraulic conductivity. The maximum path travel time, based on no down-gradient dispersion, is proportional to the ratio of porosity to hydraulic conductivity. The ranges of possible values included in probability distributions assumed for these parameters incorporate implicit assumptions about other site characteristics. High hydraulic conductivity values imply rapid trench water turnover times. High hydraulic conductivity values, especially when coupled with low porosity values, also imply short travel path times.

Site characterization indicates that fracturing is present throughout the WLT and in the upper portion of the ULT (up to 5 meters into the till) (Prudic, 1986, p. 23), but that fracturing diminishes with depth in the ULT, with little or no fracturing below 15 meters into the till (Fakundiny, 1985, p.130). Depths “into the till” are assumed to be depths below ground surface and include the full thickness of the WLT and the upper portion of the ULT. Since fracturing diminishes with depth in the ULT and the transition from significant fracturing to less significant fracturing is expected to occur over the interval between 3 and 5 meters below ground surface, it seems appropriate to the QRA Team to acknowledge the influence of less frequent fracturing in the ULTLAT3 model where lateral flow in the ULT occurs only at the base of the trenches. The March 2008 fluid levels in the trenches considered in ULTLAT3 (Trenches 1/2, 3, 4, 5, and 8) average about 1.5 meters below the WLT/ULT transition and about 1.5 meters above the base of the trenches. The regularly monitored very slow decline in trench fluid levels over the past 10 years (as trench fluid levels have declined over the till interval below the WLT/ULT transition) seems to be confirmation that low hydraulic conductivity and limited fracturing dominate in this ULT interval.

The ULTLAT2 model considers trench fluid levels at the WLT/ULT transition, which occurs about 5 meters into the till at the SDA. As such, it considers lateral flow over the ULT interval where fracturing is expected to be diminishing. The ULTLAT3 model considers lateral flow over an interval deeper into the ULT, where fracturing is expected to be further diminished. The differences in hydraulic properties assumed for the ULT in models ULTLAT2 and ULTLAT3 are believed to be appropriate recognition of the transition from fracture-dominated properties in the upper portion of the ULT to matrix-dominated properties deeper in the unit. In these models, these differences are

considered to be a single order of magnitude difference in the upper bound hydraulic conductivity for the ULT (1E-5 m/s for ULTLAT2 and 1E-6 m/s for ULTLAT3) and a single order of magnitude difference for advective porosity in the ULT (0.001 for ULTLAT2 and 0.01 for ULTLAT3).

Estimates of SDA trench water release rates and values of parameters important in determining trench water flow rate are constrained primarily by two factors. First, radionuclides released in lateral flow from the trenches through the ULT have not yet, after more than 30 years, appeared in Erdman Brook or Frank's Creek, the small streams bordering the SDA that would receive these flows. Because a number of these radionuclides are not retarded by sorption processes along the flowpath, this indicates that water released from the trenches along those flowpaths has not yet reached the streams (or that such flow does not discharge to these creeks, instead moving deeper into the ULT when trench levels are low, as hypothesized by Prudic, 1985, p. 44). Second, the time trends of H3 concentrations in trench water from the mid-1970s through the mid-1990s strongly indicate that trench water turnover times (trench water volume divided by trench water discharge flow rate) are long—on the order of 10 years or more and that water discharge rates are correspondingly low.

The form of virtually all of the H3 present in the trenches is highly likely to be HTO. Because water infiltrating into the trenches contains negligibly low concentrations of H3, turnover of trench water should continuously flush HTO from trench water. The only mode of replenishment would be new releases of H3 from previously intact waste packages, allowing dispersion of mobile HTO in trench water. This process would most likely not be a continuous process, would likely vary in magnitude and frequency from trench to trench, and would most likely diminish over time as the fraction of intact containers falls toward zero. Given that most H3 wastes were most likely shipped in packages not designed or intended for long-term containment integrity, the process may be nearly complete by now.

Concentrations of H3 in trench water from the mid-1970s through the mid-1990s are listed in the table below. Notwithstanding the possible manifestation in the data of problems posed by occasional injections of new H3 into trench water by package failure and the inevitable problems associated with sampling and analysis (e.g., the 10-11/87 results appear relatively high across all trenches), concentrations of H3 in trench water appear to be remarkably stable. Even results that appear to be anomalies are not extremely far afield of the others. Data for trenches 1, 2, 3, 4, 5, 8, 9, and 12 strongly indicate turnover times on the order of 10 years or longer. So would data for trenches 10 and 11, were it not for single anomalies for each in small datasets. Data for trenches 13 and 14, both limited datasets, do not reinforce the pattern, but only one data point for Trench 13 seems to go against it.

The upper bound value of Kh assumed for ULTLAT3, lateral flow through the lower ULT, is 1.0E-6 m/s. The corresponding maximum path travel time (assuming maximum porosity of 0.324, a reasonable maximum, and no down-gradient dispersion) is 2.9 years. Driving forces for this release path have been operative continuously for at least

the last 30 years. Non-retarded nuclides, which travel at the same velocity as water, should have been easily detectable by the stream water monitoring programs for virtually the entire period. (Concentrations of these nuclides after dilution in the streams would still be orders of magnitude higher than background.) But these nuclides have not been detected at all. A Kh value of $1.0E-6$ m/s for ULTLAT3 also implies a trench water turnover time of a little more than 1 year, cautiously substantially shorter than the turnover time of 10 years or more indicated by measurement of H3 concentrations in trench water over time, as described above. Consequently, a Kh value of $1.0E-6$ m/s should be considered a sufficiently cautious upper bound for Kh in ULTLAT3 that reasonably incorporates any effect of fracturing as it diminishes with depth through the ULT.

It should be noted that despite the short travel time calculated for the upper end of the porosity probability distribution, the lower end of the porosity probability distribution was extended to 0.01 as a precaution to account for some residual fracturing in the lower ULT on water velocity. This has the effect of shortening already short travel times even further.

The upper bound value of Kh assumed for WLTLAT, ULTLAT1, and ULTLAT2, lateral flow through the WLT and upper ULT, is $1.0E-5$ m/s, an order of magnitude higher than the upper bound for ULTLAT3, described above. The higher value for these cases was intended to account for fracturing to the extent reasonable. The corresponding maximum path travel time (assuming maximum porosity of 0.324, a reasonable maximum, and no down-gradient dispersion) is 2 months for WLTLAT and ULTLAT1 and slightly less than 3 months for ULTLAT2. Driving forces for these release paths have not been operative for most of the last 30 years, because trench water levels have been maintained at low levels. However, they were operative for a period of a year or more in the 1970s, during which the trenches actually overflowed. Non-retarded nuclides, which travel at the same velocity as water, should have appeared quickly well upstream of the overflow entry points and should have been easily detectable during this period if hydraulic conductivities had been as high as assumed for the upper bound in this analysis. (Concentrations of these nuclides after dilution in the streams would have been many orders of magnitude higher than background. Indeed, given the corresponding trench water discharge rates of 0.11 cfs, 0.17 cfs, and 0.13 cfs for WLTLAT, ULTLAT1, and ULTLAT2, respectively, trench water would have constituted a significant fraction of the total water flow in these two streams, on the order of 1 cfs in each—nearly a Kh-limiting factor in itself.) But these nuclides have not been detected in groundwater migration. A Kh value of $1.0E-5$ m/s for these models also implies extremely short trench water turnover times of 2-3 months. The stable concentrations measured in Trenches 4 and 5 during 1975 and the first half of 1976 before these trenches were pumped down are not consistent with such short turnover times. Consequently, a Kh value of $1.0E-5$ m/s should be considered a sufficiently cautious upper bound for Kh in the WLTLAT, ULTLAT1, and ULTLAT2 models and a value that reasonably incorporates effects of fracturing.

CONCENTRATIONS OF H3 IN TRENCH WATER BY TRENCH OVER TIME

	1	2	3	4	5	8	9	10	11	12	13	14
Concentration of H-3 in trench water, pCi/L, post-1974												
Prudic T15, 1976-79	3.1E+05	8.9E+07	4.8E+08			3.7E+09	4.6E+08	4.3E+09	2.8E+09	3.6E+08	4.8E+07	1.2E+08
Prudic T13, 3/75					2.0E+09							
Prudic T13, 9/75					2.2E+09							
Prudic T13, 10/75				6.0E+08	1.6E+09							
Prudic T13, 6/76				2.8E+08	1.8E+09							
Prudic T13, 9/76				3.8E+08	1.7E+09							
Prudic T13, 7/77				4.5E+08	1.4E+09	4.0E+09						
Prudic T13, 11/77				3.0E+08	9.5E+08	2.9E+09						
Prudic T13, 10/78				3.0E+08	2.3E+08	3.7E+09						
June, 1987	2.1E+05	2.8E+07	2.5E+08	1.6E+08	4.9E+08	2.0E+09	4.3E+08	2.6E+09	1.9E+09	3.2E+08	3.1E+08	
10-11/1987	3.2E+05	4.0E+07	1.4E+08	2.2E+08	2.2E+08	7.0E+09	6.7E+08	1.0E+10	6.0E+09	2.9E+08	4.2E+08	5.7E+08
1989-90				1.1E+08	8.6E+08	2.3E+09	4.6E+08	2.0E+09	1.7E+09	2.9E+08	2.6E+07	4.0E+08
1994												

The radioactive half-life of H3 is 12.3 years.

Values in italics represent apparent anomalies.

Trench 10 was sampled at two locations in 1987 and thereafter. Both values agreed within a factor of 2 in each case. The highest value is listed.

Trench 13 1989-90 1.6E+08 pCi/L after sump purge.

6.6 TRENCH FLUID VOLUMES AND RELEASE VOLUMES

This section summarizes analyses that determine the amount of precipitation that is required to fill the waste trenches and the volume of liquid that is released if the trenches overflow.

6.6.1 Trench Fluid Volumes and Overflow Scenarios

The solid materials that fill the SDA trenches are a mixture of waste materials and soil fill. According to the trench contents inventory reported in Reference 6.6-1, waste materials in 12 of the 14 SDA trenches (not including Trenches 6 and 7) comprise between 27% and 81% of trench solids, averaging 63.5% of total trench volume (based on the trapezoidal cross-section geometry). The remainder of the trench solids, averaging 36.5% of total trench volume, is assumed to be soil materials. According to information provided in Reference 6.6-2, the average porosity of trench solid materials, including the mixture of waste and soil fill, is 0.25. Thus, the trenches are believed to contain 75% solids (waste and soil) and 25% void space. Depending on fluid levels in the trenches, the void space is filled either by air (gas) or fluid.

Table 6.6-1 indicates the volumes of fluids that would be contained in the SDA trenches identified for the four fluid levels considered in the QRA analyses. These are fluid levels at: the tops of the trenches, the contact between the WLT and ULT units, March 2008 levels, and the bottoms of the trenches. These volumes are based on consideration of trapezoidal trench cross-sections that are narrower at the base than at the top.

In the "cases" listed in Table 6.6-1, the volumes listed describe the trench fluids that would be released to surface water in the event of catastrophic failures (e.g., slope failures or severe erosion) that breach the listed trenches.

Other scenarios during which fluids would be released to surface water are the "trench overflow" scenarios in Release Mechanism 3. Trench overflow would occur when other elements of the scenario have caused partial or total removal of the trench cover materials (geomembrane and soil), exposing trench-fill materials (waste and soil). In such instances, precipitation could either enter the trenches (if initial fluid levels were below the top of the trench) or come into contact with trench fluids (if the trenches were already fluid-filled). Assumptions significant to the trench overflow scenarios are as follows.

- With the trench cover materials (geomembrane and soil) removed, precipitation that falls within the trench footprint (trench area at ground surface) will fill available (air-filled) void space in the trenches or overflow the trench footprint if the trenches are already fluid-filled (no air-filled void space available).
- 100% of the precipitation amount that is not required to fill the trench to the point of overflow will become runoff that reaches the nearby creeks (Erdman Brook or Frank's Creek).
- Precipitation entering the trenches (air-filled void space available) or coming into contact with trench fluids (air-filled void space not available) will attain radionuclide concentrations (undiluted) equal to those of fluids in trenches.

- Precipitation that falls on the area occupied by the walls between trenches, and does fill air-filled void space in the trenches, will also become runoff that is assumed not to contain radionuclides.

Four initial trench fluid levels were considered for the overflow scenarios. These fluid levels and the corresponding precipitation amount (in inches) required to fill the trenches to the trench top, where all additional precipitation would become "overflow", are listed below. This condition is considered applicable to all SDA trenches except Trench 6. As a conservative assumption, the trench (or trenches) requiring the least precipitation to become filled is assumed to be representative of all SDA trenches.

<u>Trench Level</u>	<u>Precipitation Amount to Fill the Trench</u>
Initial fluid levels at trench bottoms	47.1 inches
Initial fluid levels at March 2008 levels	24.7 inches
Initial fluid levels at WLT / ULT transition	8.7 inches
Initial fluid levels at trench tops	0.0 inches

If all of the trenches were fluid-filled (fluid levels at trench top) before additional precipitation occurred, the following overflow volumes would result from the indicated additional precipitation amounts.

Additional rainfall (inches)	1.0	2.0	3.0	4.0	5.0	6.0
Overflow volume (cubic feet)	19,925	39,850	59,775	79,700	99,625	119,550

If all of the trenches were filled to the level of the WLT / ULT transition before additional precipitation occurred, 8.7 inches of precipitation would be required to fill the trench to the top, and the following precipitation events (with total precipitations greater than 8.7 inches) would result in the indicated overflow volumes.

Additional rainfall (inches)	9.0	10.0	11.0	12.0	13.0	14.0	15.0
Rainfall required to reach trench-full condition (inches)	0.3	1.3	2.3	3.3	4.3	5.3	6.3
Overflow volume (cubic feet)	5,978	25,903	45,828	65,753	85,678	105,603	125,528

6.6.2 Other Trench Filling Scenarios

Section 6.7 describes the consideration of other scenarios under which the trenches could become partly or completely filled by precipitation occurring at times when the trench geomembrane covers are partly or completely absent as a result of planned maintenance or various disruptive events. For these scenarios at each trench, the following fluid level stages between the March 2008 levels measured by NYSERDA and a trench-full condition were considered.

Beginning at the March 2008 level:

- Stage A: Fluid volume required to raise the level to midway between the March 2008 level and the elevation of the contact between the WLT and the ULT.
- Stage B: Fluid volume required to raise the level to the WLT / ULT contact.
- Stage C: Fluid volume required to raise the level to midway between the WLT / ULT contact and the elevation of the trench top.
- Stage D: Fluid volume required to raise the level to the elevation of the trench top.

For each trench, the fluid volumes required to raise the levels to the Stage A, B, C, and D levels were calculated in the same manner as those determined in Section 6.6.1. That is, the lateral trench cross-section (trapezoid) and longitudinal trench lengths were considered to determine the volume of each of the trench "slices" described as Stages A, B, C, and D. In each case, the total "slice" volume then was multiplied by 25%, the estimate of average void space (porosity) in the filled trenches, to determine the "slice" volume that would be filled with fluid at each Stage of fluid level rise.

As is described in Section 6.7, the source of the fluid (water) that could cause these rises in trench fluid levels is incident rainfall occurring during the period that the geomembrane covers are partly or completely absent. "Incident rainfall" refers to precipitation falling within the horizontal limits, or footprint, of each landfill trench at the top of the trench. Precipitation falling outside of the trench top footprint is not included.

NYSERDA descriptions and the preponderance of published information on the SDA trenches indicate that all disposal trenches (except Trenches 6 and 7) had trapezoidal cross-sections at the time of waste disposal. Because of the trapezoid-shaped lateral cross-section of each trench, the trenches are widest at the top and become narrower with increasing depth below the trench top, with the narrowing proportionate to depth below the trench top. As a result, the volume of "incident rainfall" is multiplied as it accumulates in the trench. In a similar trench with a square cross-section (same horizontal lateral dimension at the top and bottom) and void space equal to 25%, 1.0 inch of precipitation would cause 4.0 inches of fluid level rise. In the trapezoidal SDA trenches, 1.0 inch of precipitation will cause more than 4.0 inches of fluid level rise, with the actual magnitude of the rise different at each depth in the trench. At a level just below the trench top, 1.0 inch of precipitation will cause just slightly more than 4.0 inches of fluid level rise. At the level of the trench bottom, 1.0 inch of precipitation would cause about 7.0 inches of fluid level rise.

Also significant to the determination of precipitation required to cause fluid level rise to the Stage A, B, C, and D levels is the fact that the determining elevations (trench bottom, 2008 fluid level, WLT / ULT contact, and trench top) are different for each trench (References 6.6-3 and 6.6-4). Figure 6.6-1 shows the relative elevations of these fluid fill conditions for each of the SDA trenches, except Trenches 6 and 7.

Given this explanation, Table 6.6-2 indicates the precipitation totals that would cause the fluid level rises corresponding to Stages A, B, C, and D in each trench (except for Trenches 6 and 7, which have different subsurface geometries).

6.6.3 References

- 6.6-1. "SDA Radiological Characterization Report", Wild, R. E., prepared for West Valley Nuclear Services Company, Inc., URS Corporation, 2002
- 6.6-2. "Potential Leachate Level Changes after Installation of Geomembrane Cover at the New York State Licensed Low-Level Radioactive Waste Disposal Area (SDA) West Valley, New York", Dames and Moore, 1995
- 6.6-3. "Geostatistical Analysis of the Weathered Till / Unweathered Till Interface in the State-Licensed Low-Level Radioactive Waste Disposal Area", prepared by Ecology and Environment (no date).
- 6.6-4. "Trench Bottom Elevations (Weathered, Unweathered Till Interface Location)", cross-section (no date)

Table 6.6-1. Total Fluid Release Volumes in SDA Trenches	
	Fluid Release Volume (Cubic Feet)
Level 1 (Fluid level at trench tops)	
Case 1: All fluids from Trenches 1/2, 3, 4, 5, and 8	446,952
Case 2: All fluids from Trenches 1/2, 3, 4, 5, 8, and 9	524,309
Case 3: All fluids from all trenches	928,738
Level 2 (Fluid at WLT / ULT contact)	
Case 1: All fluids from Trenches 1/2, 3, 4, 5, and 8	212,613
Case 2: All fluids from Trenches 1/2, 3, 4, 5, 8, and 9	266,624
Case 3: All fluids from all trenches	568,620
Level 3 (Fluid at March 2008 levels)	
Case 1: All fluids from Trenches 1/2, 3, 4, 5, and 8	101,186
Case 2: All fluids from Trenches 1/2, 3, 4, 5, 8, and 9	110,396
Case 3: All fluids from all trenches	244,790
Level 4 (Fluid level at trench bottoms)	
Case 1: All fluids from Trenches 1/2, 3, 4, 5, and 8	0.0
Case 2: All fluids from Trenches 1/2, 3, 4, 5, 8, and 9	0.0
Case 3: All fluids from all trenches	0.0

Table 6.6-2. Required Precipitation to Fill Trenches

Trench	Inches of Rainfall Required to Cause Trench Fluid Level Rise ⁽¹⁾				
	Stage A	Stage B	Stage C	Stage D	Trench Bottom to Trench Top
1	4.3	9.0	24.4	42.6	47.1
2	5.4	11.2	22.8	35.6	47.1
3	4.2	8.7	23.2	40.1	47.1
4	4.3	8.8	22.4	38.0	47.1
5	3.7	7.6	18.1	29.6	47.1
6	--	--	--	--	--
7	--	--	--	--	--
8	11.9	25.5	29.8	34.3	47.1
9	12.5	27.3	34.2	41.5	47.1
10	10.1	21.2	25.5	30.0	47.1
11	10.0	21.4	29.6	38.3	47.1
12	9.9	21.0	27.9	35.2	47.1
13	7.7	15.9	20.2	24.7	47.1
14	8.9	18.6	24.3	30.2	47.1

Notes:

(1) Initial level for Stages A, B, C, D = March 2008 measured level (benchmark)

Stage A: Level midway between benchmark and WLT / ULT interface

Stage B: Level at WLT / ULT interface

Stage C: Level midway between WLT / ULT interface and top of trench

Stage D: Level at top of trench

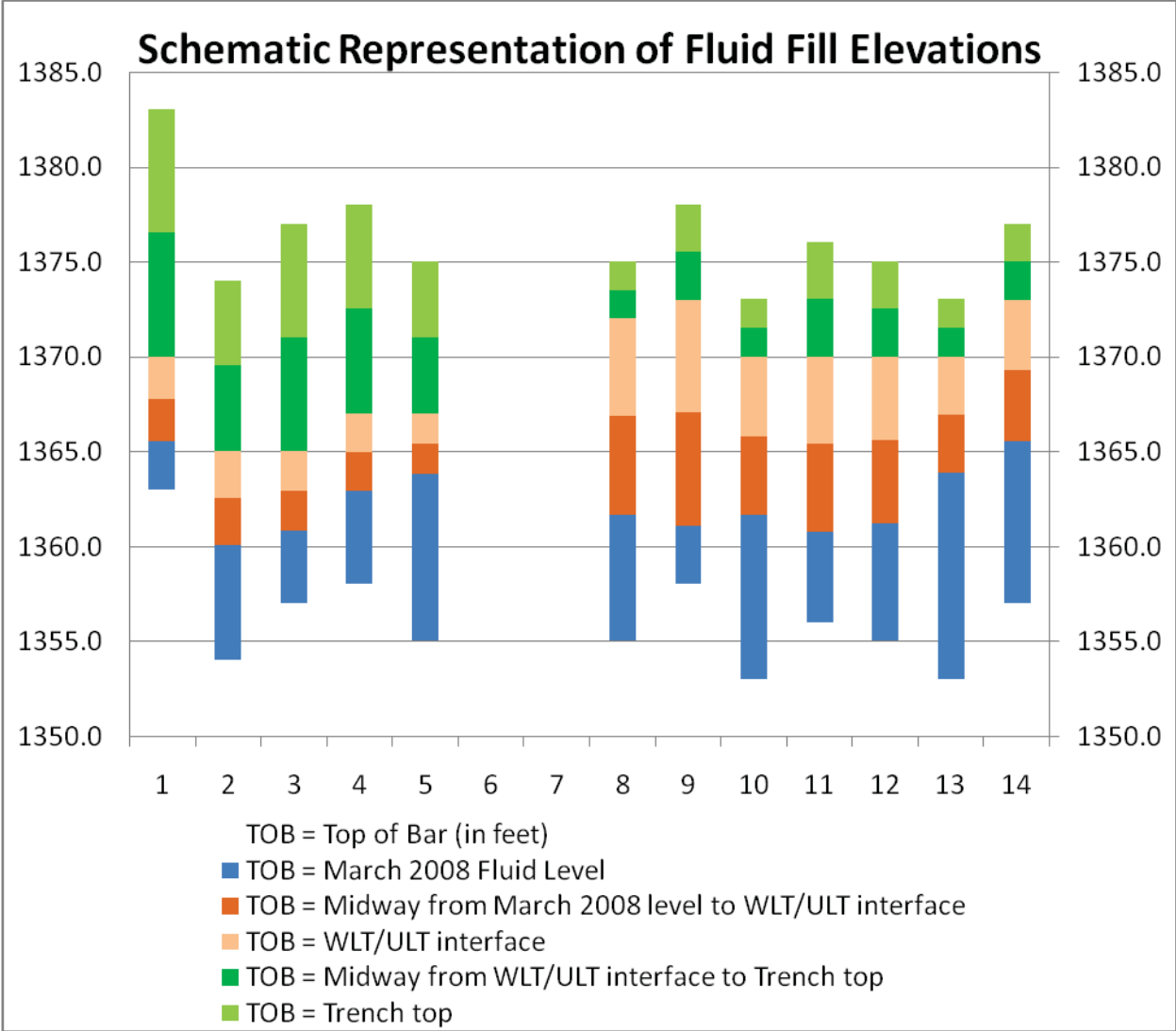

Figure 6.6-1. Schematic Representation of Trench Fluid Fill Elevations

6.7 TRENCH WATER LEVELS

Water levels in the trenches are an important input to several analyses in this study. Initial estimates of the probabilities for four potential water levels were developed during the expert elicitation sessions conducted in July 2008. In 2009, more comprehensive analyses were performed to evaluate and quantify the conditions that may cause water to enter the closed trenches, and to refine the corresponding trench water level probabilities. The updated analyses account for the following enhancements.

- Examination of the site topography and reviews of historical trench water level data to support the conclusion that surface runoff and lateral inflow through the Weathered Lavery Till are not significant contributors to water level increases
- Evaluation of specific causes for removal of the geomembranes, and quantification of the corresponding probabilities and durations
- Use of regional weather data to derive estimates for the likelihood of precipitation events that may cause the trenches to fill

This section describes the analyses. The resulting water level probabilities are used in the models and analyses for all release mechanisms that are quantified in the study.

6.7.1 Conditions for Water Intrusion

The QRA team considered three general conditions that may cause water levels in the trenches to increase above their current values: water infiltration with the geomembranes intact; water infiltration while the geomembranes are removed during planned replacement activities; and water infiltration following damage to the geomembranes by disruptive events. Potential pathways for water to enter the trenches include surface runoff from surrounding areas, lateral inflow through the Weathered Lavery Till (WLT), and precipitation that falls directly on the footprint of the trenches.

Significant infiltration from surface runoff requires a combination of prolonged ponding at some point or points along the SDA perimeter and the presence of permeable pathways leading from the ground surface beneath a ponded area directly into the trenches. "Ponding" here is intended to mean that surface and shallow WLT soil becomes saturated and that a continuing water source is present to maintain such saturation for an extended period of time. The site topography prevents such ponding to the North, South, and East of the trenches. The area uphill (West) from the SDA is a low ridge between drainages, where surface water runoff flows laterally (not across the SDA) into the adjacent creek channels. Significant ponding to the West of the SDA is not possible unless the surface is substantially disrupted by a natural event or is intentionally re-graded.

If unexpected surface water collection were to occur, the shallow, fractured, WLT layer provides a possible pathway for infiltrating water to enter the SDA area. Trenches 5 and 14 are most vulnerable to this process because they are located near the western edge of the site. Subsurface concrete and soil-bentonite barrier walls span the western side of Trench 14. The walls were designed and constructed to divert shallow groundwater flow (i.e., in the WLT and upper ULT) away from the South trenches. The top of the soil-bentonite wall extends to within

one to two feet from the ground surface. Thus, it will also divert very shallow WLT groundwater flow away from the SDA. The western edges of Trenches 5 and 14 are also bounded by surface water drainage swales. The site operating experience confirms that these engineered features successfully prevent infiltration from surface runoff and shallow groundwater pathways.

Figure E-12 in Appendix E of the draft Environmental Impact Statement (Reference 6.7-1) shows a map of the fourth quarter 2007 groundwater levels at several wells on the South Plateau. The SDA is ringed by groundwater elevation contours at 1370 feet and higher (1375 feet or higher along some sides of the SDA). Those levels generally correspond to the approximate contact elevation between the WLT and Unweathered Lavery Till (ULT) layers. In some areas, the groundwater elevations are a few feet above the WLT / ULT interface. NYSERDA measurement data show that fluid levels in all trenches were between 1360 feet and 1366 feet throughout 2007 and 2008 (Reference 6.7-2). Thus, the current trench fluid levels are approximately 10 feet **lower** than the groundwater levels in the WLT all around the site. This condition provides a relatively steep gradient and potential for groundwater flow into the SDA trenches. However, the fluid level measurement data confirm that there is very little net flow into the trenches. Most trench fluid levels have declined steadily since the mid-1990s at rates that are consistent with seepage out the trench bottoms under the control of the expected ULT vertical hydraulic conductivity.

Based on these observations and the fact that NYSERDA will continue to maintain the drainage systems and the geomembranes throughout the study period, the QRA team concluded that the potential surface-to-groundwater trench filling pathways are insignificant, compared with the other analyzed conditions. Therefore, the only pathway for water to enter the trenches considered further in these analyses is direct precipitation falling on the trenches during periods when the geomembranes are not present.

The following sections provide additional information about these conditions.

6.7.1.1 Water Infiltration with the Geomembranes Intact

The VLDPE geomembrane was installed over Trenches 13 and 14 in 1993. Trenches 1 through 8 and Trenches 10 through 12 were covered with an XR-5 geomembrane in 1995. The XR-5 geomembrane was extended to cover Trench 9 in 1999.

As discussed above, the QRA team considered possible processes and pathways that could result in significant water infiltration into the trenches while the site engineered drainage controls and geomembranes are intact. Current observations and historical data provide evidence that such postulated conditions will not contribute to significant increases in the trench levels during the 30-year study period.

The leachate levels in all trenches, except special-purpose Trenches 6 and 7, are measured quarterly. Levels in all trenches have decreased since the geomembranes and engineered drainage systems were installed. At the time of the March 2008 benchmark measurements for this study, the levels in all trenches were either decreasing slowly or were stable (Reference 6.7-2). NYSERDA has indicated that the drainage controls and geomembranes will be maintained, and quarterly level measurements will continue throughout the 30-year study period (Reference 6.7-3).

6.7.1.2 Planned Replacement of the Geomembranes

According to current expectations, two planned geomembrane replacement projects will be implemented during the 30-year time frame of the risk assessment. A new membrane will be installed over Trenches 13 and 14 (the VLDPE covered area) in 2010, and a new membrane will be installed over the remainder of the SDA (the XR-5 covered area) in approximately 2015 (Reference 6.7-4).

Detailed plans and procedures for the replacement projects have not yet been developed. The NYSERDA engineers have indicated that there are several potential benefits of installing the new geomembranes over the existing covers. However, removal of all or most of the existing covers may be required to ensure that the new geomembranes are properly anchored in the drainage swales between the trenches and at the periphery of the trench area. The NYSERDA team estimated that there is approximately 75% to 80% probability that the new geomembranes will be installed directly over the current membranes and that the trenches will remain fully covered during each replacement project. A 25% probability is assigned to the approach where large portions of the affected SDA surface area may be uncovered during these projects. In this case, precipitation that falls on the uncovered portions of the SDA during these periods may enter the trenches.

6.7.1.3 Disruptive Events that Damage the Geomembranes

Disruptive events such as high winds, tornadoes, fires, earthquakes, aircraft crashes, and meteorite impacts may damage large sections of the geomembranes. The NYSERDA team indicated that several months may be required to re-grade the damaged portions of the SDA surface area, obtain new geomembranes from the supplier, and install the new membranes. Precipitation that falls on the uncovered portions of the SDA during these periods may enter the trenches.

6.7.2 Analysis Methodology and Models

This section describes the general methodology that is used to quantify the fraction of the 30-year study period during which trench water levels may be at each reference elevation above the levels that were measured in March 2008. Two different models are used to quantify the amount of precipitation that is required to fill the trenches to each target level. The applicability of each model depends on the status of the exposed SDA surface area and the trench compacted clay caps.

6.7.2.1 General Methodology

The analyses evaluate the following contributions to conditions that may result in significant water intrusion into the SDA trenches.

- The frequency at which large sections of the SDA surface area are uncovered
- The duration of the SDA surface exposure period
- The likelihood that sufficient precipitation occurs during the exposure period to fill the trenches to each level of interest

- The time during which trench levels may remain elevated before they return to their current values

The analyses quantify the fraction of time during the 30-year study period that trench levels will remain elevated, according to the following general equation.

$$P_{L(X)} = \Phi_{MR} * P_{MR} * P_{P(TE)} * T_D \quad (6.7.1)$$

where

- $P_{L(X)}$ = Fraction of 30-year study period with trench levels at Level X
- Φ_{MR} = Frequency of a condition that may uncover a large section of the SDA surface area (event / year)
- P_{MR} = Probability that the geomembrane is removed during the event
- $P_{P(TE)}$ = Probability that sufficient precipitation occurs during an exposure period of duration TE to fill the trenches to Level X
- T_D = Time that trench levels may remain at Level X (years)

Quantification of parameter $P_{P(TE)}$ depends on the duration of the exposure period (TE), the amount of precipitation that is required to increase levels from their current values to Level X, and the likelihood that the required amount of precipitation will occur during a particular exposure period of duration TE. The following sections describe two different models that are used to evaluate this parameter and the scenario conditions for which each model applies.

6.7.2.2 Model for Conditions with Trench Caps Intact

The following conditions may result in removal of the geomembranes from a substantial portion of the SDA surface area without affecting the integrity of the compacted clay caps over each trench.

- Planned replacement of the VLDPE geomembrane
- Planned replacement of the XR-5 geomembrane
- Fires that damage the geomembranes

The clay caps are approximately 10 feet thick. They were the only deterrent against water intrusion into the trenches before installation of the groundwater barriers, geomembranes, and engineered drainage systems. These mitigation features were installed in the following years.

- 1992: Completion of subsurface groundwater barrier wall along West side of Trench 14
- 1993: Installation of VLDPE geomembrane over Trenches 13 and 14
- 1995: Installation of XR-5 geomembrane over Trenches 1 through 8, and 10 through 12
- 1999: Installation of XR-5 geomembrane over Trench 9

Detailed records of the leachate level in each trench are available from January 1986 through March 2008, the benchmark date for the QRA database (Reference 6.7-2). The database contains monthly level measurements in each trench from January 1986 through December 1998. In some years, levels were measured more frequently for specific engineering analyses. These records provide a detailed history of the level in each trench during the period before its respective geomembrane cover was installed.

Section 5.2 describes the meteorological data that were compiled for this study. Daily precipitation records are available from the Buffalo and Dunkirk regional weather stations for the period from January 1, 1986 through December 31, 1998. Daily precipitation data are also available from the West Valley site meteorological tower for the period from January 1, 1991 through December 31, 1998.

Comparison of the trench level records with the precipitation records for each year provides an empirical correlation for the rate at which water entered the trenches as a function of precipitation during the period before the geomembranes were installed. This evidence thus directly accounts for the combined effectiveness of the clay caps, surface runoff, and natural drainage features to prevent water from entering the trenches.

Based on this information, the following equation determines the amount of precipitation that is required to fill a trench from its initial level to each target level.

$$P(TE) = (L_2 - L_1) / (R_{TF} / R_P) \quad (6.7.2)$$

where

- $P(TE)$ = Required amount of precipitation to fill trench from Level L_1 to Level L_2 in exposure time TE (inches of precipitation)
 L_1 = Initial trench water level (feet)
 L_2 = Target trench water level (feet)
 R_{TF} = Rate at which trench fills with water when geomembranes are not intact (feet / year)
 R_P = Precipitation rate during trench fill database period (inches / year)

The values for parameters R_{TF} and R_P are derived from the SDA trench leachate levels and the regional precipitation records during the period before the geomembranes were installed. The quotient (R_{TF} / R_P) determines the trench fill rate in terms of feet of trench level increase per inch of precipitation.

6.7.2.3 Model for Conditions with Trench Caps Disrupted

The following events may damage large sections of the geomembranes and disrupt the integrity of the trench clay caps.

- Meteorite impacts
- Aircraft crashes
- Earthquakes
- Tornadoes
- High winds

High winds and tornadoes are not likely to cause extensive damage to the clay caps more than two or three feet below the SDA ground surface. However, these weather phenomena are typically generated by severe storm cells that also produce hail and very intense rainfalls. These combined conditions may cause extensive erosion of the caps if their surfaces are damaged. Therefore, high winds and tornadoes are conservatively included in this general category of disruptive events that may compromise the clay caps as an effective barrier against water intrusion.

Section 7.2.3 also identifies erosion of gullies in the slopes adjacent to the SDA as a disruptive event that may damage the geomembranes. The analyses in Section 6.4.4.2 show that the gully erosion scenarios are a special case. In particular, those analyses quantify the likelihood that gullies in the adjacent slopes will erode to the extent that the gully headcuts intersect the SDA boundary, which is nominally denoted by the site fence line. The SDA site boundary was used for those analyses, due to concerns that gully intrusion into the site area could disrupt the stormwater drainage systems and the peripheral anchors for the geomembranes. The erosion scenarios occur only at the North and East slopes of the SDA area. Although these scenarios may disrupt the drainage systems and the geomembrane anchors near the deepest gullies, they will not damage large areas of the membranes or the trench clay caps. Therefore, gully erosion is excluded from this analysis of disruptive events that may leave large portions of the SDA surface area uncovered.

Section 6.6.2 describes the model that is used to determine the amount of precipitation that is required to fill a trench from its initial level to each target level during conditions when the clay caps are ineffective.

6.7.3 Data and Assumptions

The following data and assumptions were applied during these analyses.

6.7.3.1 Evaluated Trench Water Levels

The analyses evaluate the following four trench water levels. These levels correspond to the conditions that were initially assessed during the expert elicitations, and they are consistent with the levels that are used throughout the QRA analyses.

- Level 1: Level is between the WLT / ULT interface and the top of the trenches. This condition is conservatively bounded by assuming that levels are at the tops of the trenches.
- Level 2: Level is between the current leachate level and the WLT / ULT interface. This condition is conservatively bounded by assuming that levels are at the WLT / ULT interface.
- Level 3: Level is at the current leachate level.
- Level 4: Level is below the current leachate level and is effectively at the bottom of the trenches.

The analyses in this section focus on conditions that may cause the levels to increase above their current values (i.e., from Level 3 to Level 2 or Level 1).

6.7.3.2 Precipitation Data

Section 5.2 describes the meteorological data that were compiled for this study. The Jamestown precipitation data were excluded from these analyses for the following reasons.

- The precipitation records for Jamestown before 1998 are very sparse. Therefore, only Jamestown precipitation records from January 1998 through April 2008 were retained in the study database.
- The Jamestown precipitation records after 1998 are also rather erratic. The Jamestown data are relevant for analyses that require only evaluation of short-term precipitation (e.g., 1-day, 2-day, or up to 14-day totals). The analyses in this section require consistently reliable data over extended exposure periods of up to several consecutive months.
- Preliminary compilations of the Jamestown precipitation data over extended periods confirmed consistent and significant deviations from the corresponding data compiled from the other reporting stations.

Therefore, only precipitation data from Buffalo, Dunkirk, and West Valley are used for these analyses.

The analyses use the most limiting data from each reporting station to evaluate the precipitation totals during each exposure period. The applications of these data are described in each analysis, and the data from all stations are provided for comparison.

6.7.3.3 Required Precipitation

Table 6.7-1 lists the reference fluid level in each trench as measured in March 2008 and the elevation difference between that level and each target level for these analyses.

The analyses summarized in Section 6.6.2 explicitly account for the trapezoidal cross-section geometry of the waste trenches. Therefore, the required precipitation results from those analyses account for the fact that a fixed amount of precipitation produces a different change in the trench water level, depending on the elevation in the trench. For example, one inch of precipitation produces a level increase of approximately 7 inches if level is initially at the bottom of the trench, but the same one inch of precipitation produces a level increase of approximately 4 inches if level is near the top of the trench.

The empirical analyses described in Section 6.7.2.2 apply the same rate of level increase (i.e., feet of level increase, per inch of precipitation) throughout the entire height of the trench. This assumption provides a conservative estimate for the amount of precipitation that is required to fill the trench to each target level. The measured trench leachate levels that are used to derive the empirical correlation are based on levels near the bottoms of the trenches, well below the WLT / ULT interface elevation. Therefore, the calculated rate of level increase applies to level changes near the narrower trench bottoms. The assumption that the same rate applies at all trench elevations provides a conservatively low estimate for the actual amount of precipitation that is required to produce the same change in level near the top of the trench.

The empirical analyses described in Section 6.7.2.2 use the annual change in level for each trench and the corresponding annual precipitation to calculate the rate of level change (i.e., feet of level increase, per inch of precipitation). Compilation of these data for each year avoids numerical effects from averaging the observed year-to-year differences in trench levels and precipitation across the entire database period. Shorter data compilation periods (e.g., quarterly or monthly) were not used, because the resulting empirical correlations might not fully account for hydrologic time delays between incident precipitation and observed changes in the

trench levels. Table 6.7-2 summarizes the measured trench level data, precipitation data, and resulting trench fill rates for each year before the geomembranes were installed.

6.7.3.4 Most Limiting Trenches

Table 6.6-2 shows the amount of precipitation that is required to fill each trench to each target level if the clay caps are damaged. The significant differences between the trenches in the North disposal area (i.e., Trenches 1 through 5) and the trenches in the South disposal area (i.e., Trenches 8 through 14) are due to the fact that the WLT / ULT interface is deeper below the ground surface at the North end of the site, as shown in Figure 6.6-1. This means that the interface is closer to the bottoms of Trenches 1 through 5. Thus, much less precipitation is required to fill those trenches to the interface level, compared with the South trenches.

These analyses determine the amount of precipitation that is required to fill the most limiting trench, depending on the specific scenario. If the most limiting trench is filled to the target level, it is conservatively assumed that all trenches are filled to that level. This assumption seems extremely conservative, especially when the intermediate level conditions in the North trenches are applied to the entire site. However, the degree of conservatism is not as extreme as may be inferred from the values in Table 6.6-2. The 2008 analyses confirmed that liquid activity releases are almost completely determined by the trenches adjacent to the North and East boundaries of the site (i.e., Trenches 1/2, 3, 8, and 9; and the North ends of Trenches 4 and 5). Therefore, although use of the North trenches to represent conditions for the entire site certainly provides conservative results, the degree of conservatism is not excessive for many of the QRA liquid release scenarios.

6.7.3.5 Analysis Precipitation Ranges

The QRA hydraulic analyses are based on the four trench levels that are summarized in Section 6.7.3.1. The analyses in this section apply the following assumptions to determine the amount of precipitation that is required to achieve each level.

- It is assumed that all trenches are filled to the WLT / ULT interface (i.e., Level 2), if the most limiting trench is filled above the midpoint between the current level and the WLT / ULT interface, and below the midpoint between the WLT / ULT interface and the top of the trench.
- It is assumed that all trenches are filled to the top (i.e., Level 1), if the most limiting trench is filled above the midpoint between the WLT / ULT interface and the top of the trench, and below the top of the trench.

For example, Table 6.6-2 shows that Trench 5 is the most limiting trench for initial level increases during conditions when the clay caps are damaged. Based on the Trench 5 analyses for those conditions, it is then assumed that all trenches are filled to the WLT / ULT interface if more than 3.7 inches and less than 18.1 inches of precipitation occur during the SDA exposure period. The minimum precipitation to completely fill the trenches is determined by Trench 13. Therefore, it is assumed that all trenches are filled to the top if more than 18.1 inches and less than 24.7 inches of precipitation occur during the same exposure period.

6.7.3.6 Duration of Increased Levels

The leachate levels in all trenches, except special-purpose Trenches 6 and 7, are now measured quarterly. The NYSERDA team has indicated that quarterly level measurements will continue throughout the 30-year study period (Reference 6.7-3).

If substantial precipitation occurs during a period when the geomembranes are not intact, it is very likely that NYSERDA will initiate actions to temporarily cover the exposed surface area. It is also likely that NYSERDA will initiate more frequent monitoring of the trench levels. However, the longest duration until increased levels are discovered would occur if the levels were not measured until the first scheduled quarterly interval after the geomembranes are fully restored (i.e., a maximum of 3 months after completion of the geomembrane installation work).

According to the SDA Leachate Monitoring Plan ENV-501, if a leachate level change of greater than 6 inches from the previous quarter or a cumulative change of greater than 10 inches over the previous two quarters is recorded, a re-measurement must be performed within five business days. If the change is confirmed by the re-measurement, a walk-around inspection of the trenches is required. Consultation with the New York State Department of Environmental Conservation (NYSDEC) is also required regarding identification of the cause for the level increase and advisable follow-up actions (Reference 6.7-3).

The NYSERDA team noted that active pumping of the trenches to return levels to their baseline conditions is not generally a preferred option. Leachate pumping will generate mixed liquid wastes that must be stored onsite for some period of time and eventually treated onsite or shipped offsite for remote treatment and disposal. Pumping may also increase the possibility of tritium releases into the SDA environment. For these reasons, NYSERDA believes that vigilant monitoring of the levels is the most appropriate and prudent course of action, especially if the data trends confirm that levels are not increasing further. This would be the situation for all scenarios that are evaluated in these analyses, after the geomembranes are fully restored.

Based on these considerations, it is assumed that NYSERDA will not implement actions to actively pump down the trenches if increased levels occur during any of the analyzed scenarios. It is very likely that more frequent trench monitoring will be initiated after the high levels are confirmed. If no extraordinary efforts are made to actively reduce the levels, the trenches will eventually drain via vertical and lateral flows through the surrounding soils. Those drainage processes and pathways are evaluated explicitly in the groundwater models and analyses that are summarized in Section 6.5.

Thus, it is assumed for these analyses that the effective duration for each increased level condition begins when the water intrusion occurs, and it terminates at the end of the 30-year study period. This assumption provides a conservative upper bound for the fraction of time during the study period that trench levels may remain elevated, and it is consistent with the interpretation and use of the trench level probabilities in the QRA models.

6.7.4 Analyses

The following analyses evaluate the conditions that may cause water levels in the trenches to increase above their current values.

6.7.4.1 VLDPE Geomembrane Replacement

The VLDPE geomembrane was installed in 1993. It extends from the crest of Trench 12 to cover Trench 13, Trench 14, and the western edge of the South Disposal Area. The NYSERDA engineers currently expect that the VLDPE geomembrane will be replaced in 2010.

Replacement of the geomembrane will not damage the trench compacted clay caps. Therefore, the empirical model described in Section 6.7.2.2 is used to derive the amount of precipitation that is required to fill the trenches during this planned replacement scenario.

SDA Surface Exposure Duration

Section 7.2.4.2 describes the geomembrane replacement projects. The following information applies to this analysis.

- Each project is assigned 75% probability that the new membrane will be installed directly over the existing cover, and 25% probability that the old cover will be substantially removed before the new membrane is installed.
- If the old membrane is removed, it is conservatively assumed that large sections of the affected trenches will remain uncovered for the full duration of the project, until the new installation is completed.
- The estimated new membrane installation times for the VLDPE-covered area are one-half the times for the XR-5-covered area. This project will re-cover less than 25% of the entire SDA. However, extra time may be required to install new anchors and seal the connections between Trench 12 and Trench 13.
- The following times are estimated for the VLDPE geomembrane replacement project.

Duration = 46 days	Probability = 0.10
Duration = 56 days	Probability = 0.80
Duration = 75 days	Probability = 0.10

Required Precipitation to Fill Trenches

Replacement of the VLDPE geomembrane will at most expose the surface of Trenches 12 through 14. Table 6.7-1 lists the reference fluid level in each trench as measured in March 2008 and the elevation difference between that level and each target level for these analyses. Equation (6.7.2) is used to determine the amount of precipitation that is required to fill the trenches to each level when the clay caps are intact. The following tables summarize the results from those calculations. The applied rate of level change (i.e., feet of level increase, per inch of precipitation) is the most limiting value for each trench, derived from the recorded annual data.

The data shown in Table 6.7-1 for Trench 13 in the years 1986 through 1990 were excluded from this analysis due to unreliable level measurements during those years (Reference 6.7-5).

Data from Table 6.7-1			
	Trench 12	Trench 13	Trench 14
Reference Level Increase Rate (ft level / in rain)	2.22E-02	8.42E-02	6.41E-02
Reference Year	1987	1991	1986
Reference Precipitation	Dunkirk	West Valley	Buffalo

Required Precipitation to Fill Trench (inches)			
Target Level	Trench 12	Trench 13	Trench 14
Midway to WLT / ULT	197.3	36.8	58.5
WLT / ULT	395.5	72.4	116.2
Midway to Trench Top	508.6	90.4	147.6
Trench Top	620.7	108.1	178.6

These results show that Trench 13 is the most limiting trench for this scenario. Thus, it is conservatively assumed that all trenches will be filled to the WLT / ULT interface if the cumulative precipitation during the SDA exposure period exceeds 36.8 inches, and is less than 90.4 inches. It is assumed that all trenches will be filled to the top if the cumulative precipitation during the SDA exposure period exceeds 90.4 inches, and is less than 108.1 inches.

These analyses provide conservative inputs to the overall SDA trench level probability estimates, because these scenarios affect only Trenches 12 through 14. The 2008 analyses confirmed that releases from these trenches are insignificant contributors to the overall liquid activity releases from the site. However, these scenarios are retained in the analyses to account for possible subsurface relocation of fluids from Trench 13 through the interstitial spaces between that trench and Trenches 8 through 12. These scenarios are also retained to ensure that the evaluated probabilities for each trench level condition represent a conservative estimate for the actual probabilities.

Precipitation Data

Meteorological data from Buffalo, Dunkirk, and West Valley were compiled to develop exceedance probabilities for the amount of precipitation that may occur during each exposure period when the geomembrane is removed. Tables 6.7-3 through 6.7-5 and Figures 6.7-1 through 6.7-3 show the results from those analyses.

The exceedance probabilities were derived from the cumulative precipitation that occurred during each sequential consecutive-day period at each reporting station. For example, Table 6.7-3 lists the following values for cumulative precipitation that exceeds 6 inches in a 46-consecutive-day period.

Buffalo: 2.29E-01
 Dunkirk: 2.38E-01
 West Valley: 2.68E-01

This means that approximately 22.9% of all 46-consecutive-day periods from the Buffalo records, 23.8% of all 46-consecutive-day periods from the Dunkirk records, and 26.8% of all 46-consecutive-day periods from the West Valley records reported a cumulative precipitation of 6 inches, or more. These data also mean that there is a 22.9% probability that a particular 46-consecutive-day period selected at random from the Buffalo records will have a cumulative precipitation of 6 inches, or more.

Exceedance Probability for Required Precipitation

Tables 6.7-3 through 6.7-5 list the following maximum cumulative precipitation for each exposure period and the corresponding exceedance probability.

Exposure Period (days)	Data	Maximum Cumulative Precipitation (inches)	Probability of Cumulative Precipitation \geq X inches
46	Buffalo	24.0	3.58E-05
56	Buffalo	26.2	3.61E-05
75	Buffalo	32.0	7.35E-05

The available data were extrapolated to estimate exceedance probabilities for the required precipitation totals for these analyses. The minimum recorded exceedance probability was conservatively assigned to the lowest required precipitation for each exposure period. A minimum probability of 1.00E-06 was assigned when the extrapolation process estimated lower values. This process provided the following exceedance probabilities for each required cumulative precipitation.

Exposure Period (days)	Probability of Cumulative Precipitation \geq X inches		
	36.8	90.4	108.1
46	3.58E-05	1.00E-06	1.00E-06
56	3.61E-05	1.00E-06	1.00E-06
75	7.35E-05	1.00E-06	1.00E-06

Duration of Increased Level

It is assumed that the 30-year period for this study starts in 2010. It is expected that the VLDPE geomembrane will be replaced in 2010. If the trench levels increase at that time and no extraordinary efforts are made to actively reduce the levels, it is assumed that the levels may remain elevated until the end of the 30-year study period, for a total of 30 years.

Probability that Level is at the WLT / ULT Interface

Equation (6.7.1) is evaluated to determine the VLDPE geomembrane replacement contribution to the fraction of time that water levels are at the WLT / ULT interface.

$$\begin{aligned} P_{L(WLT/ULT)} &= (1/30) * (0.25) * [(0.10)*(3.58E-05 - 1.00E-06) + (0.80)*(3.61E-05 - 1.00E-06) + \\ &\quad (0.10)*(7.35E-05 - 1.00E-06)] * 30 \\ &= 9.70E-06 \end{aligned}$$

Probability that Level is at the Trench Tops

Equation (6.7.1) is evaluated to determine the VLDPE geomembrane replacement contribution to the fraction of time that water levels are at the trench tops.

$$\begin{aligned} P_{L(Top)} &= (1/30) * (0.25) * [(0.10)*(1.00E-06 - 1.00E-06) + (0.80)*(1.00E-06 - 1.00E-06) + \\ &\quad (0.10)*(1.00E-06 - 1.00E-06)] * 30 \\ &= 0 \end{aligned}$$

Based on the extrapolations used for this analysis, if sufficient precipitation occurs to fill the trenches from the WLT / ULT interface to the trench tops, it is essentially certain that the amount of precipitation will also be sufficient to overflow the trenches. Therefore, it is extremely unlikely that these scenarios will terminate with trench levels between the WLT / ULT interface and the trench tops.

6.7.4.2 XR-5 Geomembrane Replacement

The XR-5 geomembrane was installed over Trenches 1 through 8 and Trenches 10 through 12 in 1995. Coverage of Trench 9 was completed in 1999. Thus, the XR-5 membrane covers all trenches, except Trenches 13 and 14. The NYSERDA engineers currently expect that the XR-5 geomembrane will be replaced in 2015.

Replacement of the geomembrane will not damage the trench compacted clay caps. Therefore, the empirical model described in Section 6.7.2.2 is used to derive the amount of precipitation that is required to fill the trenches during this planned replacement scenario.

SDA Surface Exposure Duration

Section 7.2.4.2 describes the geomembrane replacement projects. The following information applies to this analysis.

- Each project is assigned 75% probability that the new membrane will be installed directly over the existing cover, and 25% probability that the old cover will be substantially removed before the new membrane is installed.
- If the old membrane is removed, it is conservatively assumed that large sections of the affected trenches will remain uncovered for the full duration of the project, until the new installation is completed.
- The following times are estimated for the XR-5 geomembrane replacement project.
Duration = 91 days Probability = 0.10

Duration = 112 days Probability = 0.80
 Duration = 150 days Probability = 0.10

Required Precipitation to Fill Trenches

Replacement of the XR-5 geomembrane may expose almost all of the SDA surface area. Table 6.7-1 lists the reference fluid level in each trench as measured in March 2008 and the elevation difference between that level and each target level for these analyses. Equation (6.7.2) is used to determine the amount of precipitation that is required to fill the trenches to each level when the clay caps are intact. The following tables summarize the results from those calculations. The applied rate of level change (i.e., feet of level increase, per inch of precipitation) is the most limiting value for each trench, derived from the recorded annual data.

The 1991 data shown in Table 6.7-1 for Trenches 5, 8, and 10S were excluded from this analysis, due to inconsistencies in the recorded measurements when the respective level instruments were replaced (Reference 6.7-5).

Data from Table 6.7-1					
	Trench 1	Trench 2	Trench 3	Trench 4	Trench 5
Reference Level Increase Rate (ft level / in rain)	3.69E-02	1.98E-02	5.02E-03	2.10E-02	1.11E-02
Reference Year	1988	1988	1988	1991	1992
Reference Precipitation	Dunkirk	Dunkirk	Dunkirk	West Valley	Dunkirk

Required Precipitation to Fill Trench (inches)					
Target Level	Trench 1	Trench 2	Trench 3	Trench 4	Trench 5
Midway to WLT / ULT	61.2	124.7	408.4	100.0	144.1
WLT / ULT	120.9	251.0	826.7	195.2	288.3
Midway to Trench Top	297.3	478.8	2023.9	457.6	649.5
Trench Top	473.2	705.6	3217.1	719.0	1009.0

Data from Table 6.7-1					
	Trench 8	Trench 9	Trench 10	Trench 11	Trench 12
Reference Level Increase Rate (ft level / in rain)	5.02E-03	9.68E-03	1.72E-02	1.93E-02	2.22E-02
Reference Year	1988	1991	1990	1991	1987
Reference Precipitation	Dunkirk	West Valley	Dunkirk	West Valley	Dunkirk

Required Precipitation to Fill Trench (inches)					
Target Level	Trench 8	Trench 9	Trench 10	Trench 11	Trench 12
Midway to WLT / ULT	1021.9	619.8	242.4	241.5	197.3
WLT / ULT	2057.8	1229.3	486.6	479.8	395.5
Midway to Trench Top	2358.6	1488.6	574.4	635.8	508.6
Trench Top	2655.4	1745.9	661.0	790.7	620.7

These results show that Trench 1 is the most limiting trench for this scenario. Thus, it is conservatively assumed that all trenches will be filled to the WLT / ULT interface if the cumulative precipitation during the SDA exposure period exceeds 61.2 inches, and is less than 297.3 inches. It is assumed that all trenches will be filled to the top if the cumulative precipitation during the SDA exposure period exceeds 297.3 inches, and is less than 473.2 inches.

These analyses provide very conservative inputs to the trench level probability estimates for the South Disposal Area, because Trench 1 determines the most limiting precipitation requirements. However, the 2008 analyses confirmed that liquid activity releases are almost completely determined by the trenches adjacent to the North and East boundaries of the site (i.e., Trenches 1/2, 3, 8, and 9; and the North ends of Trenches 4 and 5). Therefore, although the use of Trench 1 to represent conditions for the entire site provides limiting results for these analyses, it is not excessively conservative for many of the QRA liquid release scenarios.

Precipitation Data

Meteorological data from Buffalo, Dunkirk, and West Valley were compiled to develop exceedance probabilities for the amount of precipitation that may occur during each exposure period when the geomembrane is removed. Tables 6.7-6 through 6.7-8 and Figures 6.7-4 through 6.7-6 show the results from those analyses.

The exceedance probabilities were derived from the cumulative precipitation that occurred during each sequential consecutive-day period at each reporting station. For example, Table 6.7-6 lists the following values for cumulative precipitation that exceeds 6 inches in a 91-consecutive-day period.

Buffalo: 8.49E-01
 Dunkirk: 8.94E-01
 West Valley: 9.28E-01

This means that approximately 84.9% of all 91-consecutive-day periods from the Buffalo records, 89.4% of all 91-consecutive-day periods from the Dunkirk records, and 92.8% of all 91-consecutive-day periods from the West Valley records reported a cumulative precipitation of 6 inches, or more. These data also mean that there is an 84.9% probability that a particular 91-consecutive-day period selected at random from the Buffalo records will have a cumulative precipitation of 6 inches, or more.

Exceedance Probability for Required Precipitation

Tables 6.7-6 through 6.7-8 list the following maximum cumulative precipitation for each exposure period and the corresponding exceedance probability.

Exposure Period (days)	Data	Maximum Cumulative Precipitation (inches)	Probability of Cumulative Precipitation \geq X inches
91	Buffalo	36.0	3.73E-05
112	Buffalo	42.0	2.28E-04
150	Buffalo	55.0	7.90E-05

The available data were extrapolated to estimate exceedance probabilities for the required precipitation totals for these analyses. An exceedance probability corresponding to one event in the database period was conservatively assigned to the lowest required precipitation for each exposure period. A minimum probability of 1.00E-06 was assigned when the extrapolation process estimated lower values for the intermediate precipitation amounts. A probability of zero was assigned that the cumulative precipitation will exceed 400 inches during any of these exposure periods. This process provided the following exceedance probabilities for each required cumulative precipitation.

Exposure Period (days)	Probability of Cumulative Precipitation \geq X inches		
	61.2	297.3	473.2
91	3.73E-05	1.00E-06	0
112	3.81E-05	1.00E-06	0
150	3.95E-05	1.00E-06	0

Duration of Increased Level

It is assumed that the 30-year period for this study starts in 2010. It is expected that the XR-5 geomembrane will be replaced in 2015. If the trench levels increase at that time and no extraordinary efforts are made to actively reduce the levels, it is assumed that the levels may remain elevated until the end of the 30-year study period, for a total of 25 years.

Probability that Level is at the WLT / ULT Interface

Equation (6.7.1) is evaluated to determine the XR-5 geomembrane replacement contribution to the fraction of time that water levels are at the WLT / ULT interface.

$$\begin{aligned} P_{L(WLT/ULT)} &= (1/30) * (0.25) * [(0.10)*(3.73E-05 - 1.00E-06) + (0.80)*(3.81E-05 - 1.00E-06) + \\ &\quad (0.10)*(3.95E-05 - 1.00E-06)] * 25 \\ &= 7.74E-06 \end{aligned}$$

Probability that Level is at the Trench Tops

Equation (6.7.1) is evaluated to determine the XR-5 geomembrane replacement contribution to the fraction of time that water levels are at the trench tops.

$$\begin{aligned} P_{L(Top)} &= (1/30) * (0.25) * [(0.10)*(1.00E-06) + (0.80)*(1.00E-06) + (0.10)*(1.00E-06)] * 25 \\ &= 2.08E-07 \end{aligned}$$

This estimate is essentially determined by the limiting probability of 1.00E-06 that cumulative precipitation may exceed 297 inches, and the assigned probability of zero that more than 470 inches of precipitation will occur during any of these exposure periods.

6.7.4.3 Disruptive Events with Clay Caps Intact

The following types of disruptive events may damage the geomembranes, but not the trench clay caps.

- Wildfires
- Gas pipeline fires

Table 7.2-1 summarizes the frequency of each disruptive event that may damage the geomembranes. The mean total frequency of these fires is 5.55E-03 event per year (i.e., one event in 180 years).

The empirical model described in Section 6.7.2.2 is used to derive the amount of precipitation that is required to fill the trenches during each of these damage scenarios.

SDA Surface Exposure Duration

Section 7.2.4.1 summarizes the NYSERDA estimates for the amount of time that is required to replace the geomembranes after an unexpected damaging event. The times are determined primarily by the amount of time that is required to manufacture new geomembranes according to the SDA specifications and to install the new membranes after they arrive onsite.

- The following times are estimated to replace the geomembranes after unexpected damage.
Duration = 196 days Probability = 0.10
Duration = 252 days Probability = 0.80
Duration = 356 days Probability = 0.10

Required Precipitation to Fill Trenches

It is assumed that these disruptive events may damage a large fraction of the geomembrane area. Table 6.7-1 lists the reference fluid level in each trench as measured in March 2008 and the elevation difference between that level and each target level for these analyses. Equation (6.7.2) is used to determine the amount of precipitation that is required to fill the trenches to each level when the clay caps are intact. The following tables summarize the results from those calculations. The applied rate of level change (i.e., feet of level increase, per inch of precipitation) is the most limiting value for each trench, derived from the recorded annual data.

The data shown in Table 6.7-1 for the following trenches were excluded from this analysis, based on the information in Reference 6.7-5.

- Trenches 5, 8, and 10S: 1991; replacement of level instruments
- Trench 13: 1986 through 1990; unreliable level measurements

Data from Table 6.7-1						
	Trench 1	Trench 2	Trench 3	Trench 4	Trench 5	Trench 8
Reference Level Increase Rate (ft level / in rain)	3.69E-02	1.98E-02	5.02E-03	2.10E-02	1.11E-02	5.02E-03
Reference Year	1988	1988	1988	1991	1992	1988
Reference Precipitation	Dunkirk	Dunkirk	Dunkirk	West Valley	Dunkirk	Dunkirk

Required Precipitation to Fill Trench (inches)						
Target Level	Trench 1	Trench 2	Trench 3	Trench 4	Trench 5	Trench 8
Midway to WLT / ULT	61.2	124.7	408.4	100.0	144.1	1021.9
WLT / ULT	120.9	251.0	826.7	195.2	288.3	2057.8
Midway to Trench Top	297.3	478.8	2023.9	457.6	649.5	2358.6
Trench Top	473.2	705.6	3217.1	719.0	1009.0	2655.4

Data from Table 6.7-1						
	Trench 9	Trench 10	Trench 11	Trench 12	Trench 13	Trench 14
Reference Level Increase Rate (ft level / in rain)	9.68E-03	1.72E-02	1.93E-02	2.22E-02	8.42E-02	6.41E-02
Reference Year	1991	1990	1991	1987	1991	1986
Reference Precipitation	West Valley	Dunkirk	West Valley	Dunkirk	West Valley	Buffalo

Required Precipitation to Fill Trench (inches)						
Target Level	Trench 9	Trench 10	Trench 11	Trench 12	Trench 13	Trench 14
Midway to WLT / ULT	619.8	242.4	241.5	197.3	36.8	58.5
WLT / ULT	1229.3	486.6	479.8	395.5	72.4	116.2
Midway to Trench Top	1488.6	574.4	635.8	508.6	90.4	147.6
Trench Top	1745.9	661.0	790.7	620.7	108.1	178.6

These results show that Trench 13 is the most limiting trench (i.e., requires the least rainfall to fill) for these scenarios. Thus, it is conservatively assumed that all trenches will be filled to the WLT / ULT interface if the cumulative precipitation during the SDA exposure period exceeds 36.8 inches, and is less than 90.4 inches. It is assumed that all trenches will be filled to the top if the cumulative precipitation during the SDA exposure period exceeds 90.4 inches, and is less than 108.1 inches.

These analyses provide conservative inputs to the overall SDA trench level probability estimates, because Trench 13 determines the most limiting precipitation requirements. The 2008 analyses confirmed that releases from Trench 13 are insignificant contributors to the overall liquid activity releases from the site. However, these scenarios are retained in the analyses to account for possible subsurface relocation of fluids from Trench 13 through the interstitial spaces between that trench and Trenches 8 through 12. These scenarios are also retained to ensure that the evaluated probabilities for each trench level condition represent a conservative estimate for the actual probabilities.

Precipitation Data

Meteorological data from Buffalo, Dunkirk, and West Valley were compiled to develop exceedance probabilities for the amount of precipitation that may occur during each of these exposure periods. Tables 6.7-9 through 6.7-11 and Figures 6.7-7 through 6.7-9 show the results from those analyses.

The exceedance probabilities were derived from the cumulative precipitation that occurred during each sequential consecutive-day period at each reporting station. For example, Table 6.7-9 lists the following values for cumulative precipitation that exceeds 6 inches in a 196-consecutive-day period.

Buffalo: 9.98E-01
 Dunkirk: 1.0
 West Valley: 1.0

This means that approximately 99.8% of all 196-consecutive-day periods from the Buffalo records, all 196-consecutive-day periods from the Dunkirk records, and all 196-consecutive-day periods from the West Valley records reported a cumulative precipitation of 6 inches, or more. These data also mean that there is a 99.8% probability that a particular 196-consecutive-day period selected at random from the Buffalo records will have a cumulative precipitation of 6 inches, or more.

Exceedance Probability for Required Precipitation

The following table summarizes the relevant exceedance probabilities from Tables 6.7-9 through 6.7-11 for each required cumulative precipitation. Probabilities for intermediate precipitation values were determined by linear interpolation.

Exposure Period (days)	Data	Probability of Cumulative Precipitation \geq X inches		
		36.8	90.4	108.1
196	Buffalo	6.57E-02	N/A	N/A
	Dunkirk	7.11E-03	N/A	N/A
	West Valley	N/A	N/A	N/A
252	Buffalo	1.06E-01	N/A	N/A
	Dunkirk	4.79E-02	N/A	N/A
	West Valley	3.04E-02	N/A	N/A
356	Buffalo	5.01E-01	1.57E-02	1.45E-04
	Dunkirk	4.79E-01	N/A	N/A
	West Valley	7.23E-01	N/A	N/A

The available data were extrapolated to estimate exceedance probabilities for the required precipitation totals for these analyses. This process provided the following exceedance probabilities for each required cumulative precipitation.

Exposure Period (days)	Probability of Cumulative Precipitation $\geq X$ inches		
	36.8	90.4	108.1
196	6.57E-02	4.14E-05	3.00E-06
252	1.06E-01	1.50E-04	5.00E-06
356	7.23E-01	1.57E-02	1.45E-04

Duration of Increased Level

It is assumed that the 30-year period for this study starts in 2010. A disruptive event may occur randomly at any time during this period. If the trenches fill when the event occurs, the levels may remain elevated until the end of the 30-year study period. Based on the random frequency of these events, the mean duration of this period is 15 years.

Probability that Level is at the WLT / ULT Interface

Equation (6.7.1) is evaluated to determine the disruptive event contribution to the fraction of time that water levels are at the WLT / ULT interface.

$$\begin{aligned}
 P_{L(WLT/ULT)} &= (5.55E-03) * (1.0) * [(0.10)*(6.57E-02 - 4.14E-05) + (0.80)*(1.06E-01 - 1.50E-04) \\
 &\quad + (0.10)*(7.23E-01 - 1.57E-02)] * 15 \\
 &= 1.35E-02
 \end{aligned}$$

Probability that Level is at the Trench Tops

Equation (6.7.1) is evaluated to determine the disruptive event contribution to the fraction of time that water levels are at the trench tops.

$$\begin{aligned}
 P_{L(Top)} &= (5.55E-03) * (1.0) * [(0.10)*(4.14E-05 - 3.00E-06) + (0.80)*(1.50E-04 - 5.00E-06) \\
 &\quad + (0.10)*(1.57E-02 - 1.45E-04)] * 15 \\
 &= 1.39E-04
 \end{aligned}$$

6.7.4.4 Disruptive Events with Clay Caps Damaged

The following types of disruptive events may damage the geomembranes and the trench clay caps.

- High winds and tornadoes
- Earthquakes
- Aircraft crashes
- Meteorite impacts

Table 7.2-1 summarizes the frequency of each disruptive event that may damage the geomembranes. The mean total frequency of these damaging events is 2.72E-04 event per year (i.e., one event in 3,675 years).

The model described in Section 6.7.2.3 is used to derive the amount of precipitation that is required to fill the trenches during each of these damage scenarios.

SDA Surface Exposure Duration

Section 7.2.4.1 summarizes the NYSERDA estimates for the amount of time that is required to replace the geomembranes after an unexpected damaging event. The times are determined primarily by the amount of time that is required to manufacture new geomembranes according to the SDA specifications and to install the new membranes after they arrive onsite.

- The following times are estimated to replace the geomembranes after unexpected damage.
 - Duration = 196 days Probability = 0.10
 - Duration = 252 days Probability = 0.80
 - Duration = 356 days Probability = 0.10

Required Precipitation to Fill Trenches

It is assumed that any of these disruptive events may damage a large fraction of the geomembrane area. Table 6.6-2 lists the following amounts of precipitation that are required to fill the most limiting trenches to the target levels when the clay caps are not intact.

Target Level	Limiting Trench	Required Precipitation (inches)
Midway to WLT / ULT interface	5	3.7
WLT / ULT interface	5	7.6
Midway from WLT / ULT interface to trench top	5	18.1
Top of trench	13	24.7

For these analyses, it is conservatively assumed that all trenches will be filled to the WLT / ULT interface if the cumulative precipitation during the SDA exposure period exceeds 3.7 inches, and is less than 18.1 inches. It is assumed that all trenches will be filled to the top if the cumulative precipitation during the SDA exposure period exceeds 18.1 inches, and is less than 24.7 inches. An upper-bound cumulative precipitation of 24.6 inches was used in the analyses to ensure that levels remain below the tops of the trenches.

These analyses provide very conservative inputs to the trench level probability estimates for the South Disposal Area, because Trench 5 determines the most limiting precipitation requirements. However, the 2008 analyses confirmed that liquid activity releases are almost completely determined by the trenches adjacent to the North and East boundaries of the site (i.e., Trenches 1/2, 3, 8, and 9; and the North ends of Trenches 4 and 5). Therefore, although the use of Trench 5 to represent conditions for the entire site provides limiting results for these analyses, it is not excessively conservative for many of the QRA liquid release scenarios.

Precipitation Data

Meteorological data from Buffalo, Dunkirk, and West Valley were compiled to develop exceedance probabilities for the amount of precipitation that may occur during each of these exposure periods. Tables 6.7-9 through 6.7-11 and Figures 6.7-7 through 6.7-9 show the results from those analyses.

The exceedance probabilities were derived from the cumulative precipitation that occurred during each sequential consecutive-day period at each reporting station. For example, Table 6.7-9 lists the following values for cumulative precipitation that exceeds 6 inches in a 196-consecutive-day period.

Buffalo: 9.98E-01
 Dunkirk: 1.0
 West Valley: 1.0

This means that approximately 99.8% of all 196-consecutive-day periods from the Buffalo records, all 196-consecutive-day periods from the Dunkirk records, and all 196-consecutive-day periods from the West Valley records reported a cumulative precipitation of 6 inches, or more. These data also mean that there is a 99.8% probability that a particular 196-consecutive-day period selected at random from the Buffalo records will have a cumulative precipitation of 6 inches, or more.

Exceedance Probability for Required Precipitation

The following table summarizes the relevant exceedance probabilities from Tables 6.7-9 through 6.7-11 for each required cumulative precipitation. Probabilities for intermediate precipitation values were determined by linear interpolation.

Exposure Period (days)	Data	Probability of Cumulative Precipitation \geq X inches		
		3.7	18.1	24.6
196	Buffalo	1.00E+00	6.07E-01	2.01E-01
	Dunkirk	1.00E+00	6.82E-01	1.69E-01
	West Valley	1.00E+00	7.44E-01	1.98E-01
252	Buffalo	1.00E+00	8.87E-01	5.60E-01
	Dunkirk	1.00E+00	9.54E-01	6.07E-01
	West Valley	1.00E+00	9.75E-01	7.24E-01
356	Buffalo	1.00E+00	9.94E-01	9.33E-01
	Dunkirk	1.00E+00	1.00E+00	9.92E-01
	West Valley	1.00E+00	1.00E+00	1.00E+00

Duration of Increased Level

It is assumed that the 30-year period for this study starts in 2010. A disruptive event may occur randomly at any time during this period. If the trenches fill when the event occurs, the levels may remain elevated until the end of the 30-year study period. Based on the random frequency of these events, the mean duration of this period is 15 years.

Probability that Level is at the WLT / ULT Interface

Equation (6.7.1) is evaluated to determine the disruptive event contribution to the fraction of time that water levels are at the WLT / ULT interface. The West Valley data are used to evaluate the exceedance probabilities for cumulative precipitation in excess of 3.7 inches and 18.1 inches.

$$\begin{aligned} P_{L(WLT/ULT)} &= (2.72E-04) * (1.0) * [(0.10)*(1.0 - 7.44E-01) + (0.80)*(1.0 - 9.75E-01) + \\ &\quad (0.10)*(1.0 - 1.0)] * 15 \\ &= 1.86E-04 \end{aligned}$$

Probability that Level is at the Trench Tops

Equation (6.7.1) is evaluated to determine the disruptive event contribution to the fraction of time that water levels are at the trench tops. The West Valley data are used to evaluate the exceedance probabilities for cumulative precipitation in excess of 18.1 inches. The West Valley data are also used to evaluate the exceedance probabilities for cumulative precipitation in excess of 24.6 inches for the 252-day and 356-day exposure periods. The Buffalo data are used to evaluate the exceedance probability for cumulative precipitation in excess of 24.6 inches for the 196-day exposure period.

$$\begin{aligned} P_{L(Top)} &= (2.72E-04) * (1.0) * [(0.10)*(7.44E-01 - 2.01E-01) + (0.80)*(9.75E-01 - 7.24E-01) \\ &\quad + (0.10)*(1.0 - 1.0)] * 15 \\ &= 1.04E-03 \end{aligned}$$

6.7.5 Summary of Results

The following tables summarize the results from the trench filling analyses.

Level at WLT / ULT Interface	
Condition	Fraction of 30-Year Period
VLDPE planned replacement	9.70E-06
XR-5 planned replacement	7.74E-06
Disruptive event (caps intact)	1.35E-02
Disruptive event (caps damaged)	1.86E-04
Total	1.37E-02

Level at Trench Tops	
Condition	Fraction of 30-Year Period
VLDPE planned replacement	0
XR-5 planned replacement	2.08E-07
Disruptive event (caps intact)	1.39E-04
Disruptive event (caps damaged)	1.04E-03
Total	1.18E-03

Disruptive events are the most important cause for both elevated level conditions because the SDA surface remains exposed for an average period of more than 8 months after these events. If the trench caps are damaged, it is quite likely that sufficient precipitation will occur during this time to fill the trenches well above the WLT / ULT interface. Therefore, the damaged cap scenarios are relatively insignificant contributors to conditions that partially fill the trenches. However, they account for almost 90% of the "trench full" probability, despite their low frequency of occurrence.

During the July 2008 elicitation sessions, the experts acknowledged the observation that trench levels are currently decreasing, but at a relatively slow rate. The experts estimated that continuing lateral flow into the trenches through the WLT makes it unlikely that levels will decrease significantly below their current values under steady-state conditions. Therefore, a 5% probability was assigned to Level 4 (i.e., water levels at the bottom of the trenches). This estimate is retained for the current analyses.

In summary, the following probabilities apply for the four discrete trench water levels.

Level	Trench Water Level	Probability
1	Trench Tops	0.12%
2	WLT / ULT Interface	1.37%
3	March 2008 Benchmark Conditions	93.51%
4	Trench Bottoms	5.00%

6.7.6 References

- 6.7-1. "Revised Draft Environmental Impact Statement for Decommissioning and/or Long-Term Stewardship at the West Valley Demonstration Project and Western New York Nuclear Service Center", DOE/EIS-0226-R, United States Department of Energy and New York State Energy Research and Development Authority, predecisional - concurrence draft for multiagency review, September 2008
- 6.7-2. "1986 to 2008 SDA Leachate Elevations", Excel spreadsheet, E-mail communication, P. J. Bembia, NYSERDA, to J. W. Stetkar, July 10, 2008

- 6.7-3. E-mail communication, P. J. Bembia, NYSERDA, to J. W. Stetkar, April 14, 2009
- 6.7-4. E-mail communication, P. J. Bembia, NYSERDA, to J. W. Stetkar, April 29, 2009
- 6.7-5. E-mail communication, A. L. Mellon, NYSERDA, to J. W. Stetkar, April 23, 2009

Table 6.7-1. Trench Reference Levels					
Trench	March 2008 Fluid Level	Elevation Difference from March 2008 to Target Level (feet)			
		Midway to WLT / ULT Interface	WLT / ULT Interface	Midway from Interface to Trench Top	Trench Top
1	1365.54	2.26	4.46	10.97	17.46
2	1360.03	2.47	4.97	9.48	13.97
3	1360.85	2.05	4.15	10.16	16.15
4	1362.9	2.1	4.1	9.61	15.1
5	1363.8	1.6	3.2	7.21	11.2
8	1361.67	5.13	10.33	11.84	13.33
9	1361.1	6	11.9	14.41	16.9
10	1361.63	4.17	8.37	9.88	11.37
11	1360.74	4.66	9.26	12.27	15.26
12	1361.22	4.38	8.78	11.29	13.78
13	1363.9	3.1	6.1	7.61	9.1
14	1365.55	3.75	7.45	9.46	11.45

Table 6.7-2. Trench Levels and Precipitation, Years Before Geomembranes Installed										
Trench	Year	Level Change (feet)	Precipitation (inches)			Trench Fill Rate (feet level / inch rain)				
			Buffalo Data	Dunkirk Data	West Valley Data	Buffalo Data	Dunkirk Data	West Valley Data		
1	1986	-0.50	41.67	55.12	N / A	-1.20E-02	-9.07E-03	N / A		
1	1987	-1.92	42.65	37.79	N / A	-4.50E-02	-5.08E-02	N / A		
1	1988	1.25	38.15	33.87	N / A	3.28E-02	3.69E-02	N / A		
1	1989	0.25	43.79	38.38	N / A	5.71E-03	6.51E-03	N / A		
1	1990	-0.09	49.85	48.20	N / A	-1.81E-03	-1.87E-03	N / A		
1	1991	-0.91	41.38	34.45	32.76	-2.21E-02	-2.65E-02	-2.79E-02		
1	1992	-0.08	66.41	43.19	48.63	-1.20E-03	-1.85E-03	-1.65E-03		
1	1993	-0.34	100.50	39.07	37.35	-3.38E-03	-8.70E-03	-9.10E-03		
1	1994	0.19	36.83	N / A	40.13	5.16E-03	N / A	4.73E-03		
2	1986	0.41	41.67	55.12	N / A	9.84E-03	7.44E-03	N / A		
2	1987	0.00	42.65	37.79	N / A	0.00E+00	0.00E+00	N / A		
2	1988	0.67	38.15	33.87	N / A	1.76E-02	1.98E-02	N / A		
2	1989	0.33	43.79	38.38	N / A	7.54E-03	8.60E-03	N / A		
2	1990	0.42	49.85	48.20	N / A	8.49E-03	8.78E-03	N / A		
2	1991	0.21	41.38	34.45	32.76	5.15E-03	6.18E-03	6.50E-03		
2	1992	0.15	66.41	43.19	48.63	2.26E-03	3.47E-03	3.08E-03		
2	1993	-0.13	100.50	39.07	37.35	-1.29E-03	-3.33E-03	-3.48E-03		
2	1994	0.28	36.83	N / A	40.13	7.60E-03	N / A	6.98E-03		

Table 6.7-2. Trench Levels and Precipitation, Years Before Geomembranes Installed										
Trench	Year	Level Change (feet)	Precipitation (inches)			Trench Fill Rate (feet level / inch rain)				
			Buffalo Data	Dunkirk Data	West Valley Data	Buffalo Data	Dunkirk Data	West Valley Data		
3	1986	0.08	41.67	55.12	N / A	1.92E-03	1.45E-03	N / A		
3	1987	-0.09	42.65	37.79	N / A	-2.11E-03	-2.38E-03	N / A		
3	1988	0.17	38.15	33.87	N / A	4.46E-03	5.02E-03	N / A		
3	1989	-0.08	43.79	38.38	N / A	-1.83E-03	-2.08E-03	N / A		
3	1990	0.16	49.85	48.20	N / A	3.21E-03	3.32E-03	N / A		
3	1991	-0.15	41.38	34.45	32.76	-3.55E-03	-4.27E-03	-4.49E-03		
3	1992	0.13	66.41	43.19	48.63	1.96E-03	3.01E-03	2.67E-03		
3	1993	-0.11	100.50	39.07	37.35	-1.09E-03	-2.82E-03	-2.95E-03		
3	1994	-0.04	36.83	N / A	40.13	-1.09E-03	N / A	-9.97E-04		
4	1986	0.17	41.67	55.12	N / A	4.08E-03	3.08E-03	N / A		
4	1987	-0.09	42.65	37.79	N / A	-2.11E-03	-2.38E-03	N / A		
4	1988	0.00	38.15	33.87	N / A	0.00E+00	0.00E+00	N / A		
4	1989	0.17	43.79	38.38	N / A	3.88E-03	4.43E-03	N / A		
4	1990	0.08	49.85	48.20	N / A	1.60E-03	1.66E-03	N / A		
4	1991	0.69	41.38	34.45	32.76	1.66E-02	1.99E-02	2.10E-02		
4	1992	-0.54	66.41	43.19	48.63	-8.13E-03	-1.25E-02	-1.11E-02		
4	1993	-0.12	100.50	39.07	37.35	-1.19E-03	-3.07E-03	-3.21E-03		
4	1994	0.05	36.83	N / A	40.13	1.36E-03	N / A	1.25E-03		

Table 6.7-2. Trench Levels and Precipitation, Years Before Geomembranes Installed

Trench	Year	Level Change (feet)	Precipitation (inches)			Trench Fill Rate (feet level / inch rain)		
			Buffalo Data	Dunkirk Data	West Valley Data	Buffalo Data	Dunkirk Data	West Valley Data
5	1986	0.42	41.67	55.12	N / A	1.01E-02	7.62E-03	N / A
5	1987	0.08	42.65	37.79	N / A	1.88E-03	2.12E-03	N / A
5	1988	0.00	38.15	33.87	N / A	0.00E+00	0.00E+00	N / A
5	1989	0.33	43.79	38.38	N / A	7.54E-03	8.60E-03	N / A
5	1990	0.26	49.85	48.20	N / A	5.16E-03	5.33E-03	N / A
5	1991	0.82	41.38	34.45	32.76	1.97E-02	2.37E-02	2.49E-02
5	1992	0.48	66.41	43.19	48.63	7.23E-03	1.11E-02	9.87E-03
5	1993	-0.13	100.50	39.07	37.35	-1.29E-03	-3.33E-03	-3.48E-03
5	1994	0.22	36.83	N / A	40.13	5.97E-03	N / A	5.48E-03
8	1986	0.17	41.67	55.12	N / A	4.08E-03	3.08E-03	N / A
8	1987	0.08	42.65	37.79	N / A	1.88E-03	2.12E-03	N / A
8	1988	0.17	38.15	33.87	N / A	4.46E-03	5.02E-03	N / A
8	1989	-0.50	43.79	38.38	N / A	-1.14E-02	-1.30E-02	N / A
8	1990	-0.11	49.85	48.20	N / A	-2.27E-03	-2.34E-03	N / A
8	1991	0.95	41.38	34.45	32.76	2.30E-02	2.76E-02	2.90E-02
8	1992	0.09	66.41	43.19	48.63	1.36E-03	2.08E-03	1.85E-03
8	1993	0.01	100.50	39.07	37.35	9.95E-05	2.56E-04	2.68E-04
8	1994	0.02	36.83	N / A	40.13	5.43E-04	N / A	4.98E-04

Table 6.7-2. Trench Levels and Precipitation, Years Before Geomembranes Installed

Trench	Year	Level Change (feet)	Precipitation (inches)			Trench Fill Rate (feet level / inch rain)		
			Buffalo Data	Dunkirk Data	West Valley Data	Buffalo Data	Dunkirk Data	West Valley Data
9	1986	0.33	41.67	55.12	N / A	7.92E-03	5.99E-03	N / A
9	1987	0.17	42.65	37.79	N / A	3.99E-03	4.50E-03	N / A
9	1988	0.25	38.15	33.87	N / A	6.55E-03	7.38E-03	N / A
9	1989	0.25	43.79	38.38	N / A	5.71E-03	6.51E-03	N / A
9	1990	-0.04	49.85	48.20	N / A	-8.02E-04	-8.30E-04	N / A
9	1991	0.32	41.38	34.45	32.76	7.66E-03	9.20E-03	9.68E-03
9	1992	0.12	66.41	43.19	48.63	1.81E-03	2.78E-03	2.47E-03
9	1993	-0.07	100.50	39.07	37.35	-6.97E-04	-1.79E-03	-1.87E-03
9	1994	0.10	36.83	N / A	40.13	2.72E-03	N / A	2.49E-03
9	1995	0.11	103.52	N / A	34.17	1.06E-03	N / A	3.22E-03
9	1996	0.05	58.18	27.36	44.89	8.59E-04	1.83E-03	1.11E-03
9	1997	-0.14	31.75	37.33	43.35	-4.41E-03	-3.75E-03	-3.23E-03
9	1998	0.03	30.99	31.54	43.00	9.68E-04	9.51E-04	6.98E-04
10N	1986	0.08	41.67	55.12	N / A	1.92E-03	1.45E-03	N / A
10N	1987	0.00	42.65	37.79	N / A	0.00E+00	0.00E+00	N / A
10N	1988	0.09	38.15	33.87	N / A	2.36E-03	2.66E-03	N / A
10N	1989	0.08	43.79	38.38	N / A	1.83E-03	2.08E-03	N / A
10N	1990	0.33	49.85	48.20	N / A	6.62E-03	6.85E-03	N / A

Table 6.7-2. Trench Levels and Precipitation, Years Before Geomembranes Installed										
Trench	Year	Level Change (feet)	Precipitation (inches)			Trench Fill Rate (feet level / inch rain)				
			Buffalo Data	Dunkirk Data	West Valley Data	Buffalo Data	Dunkirk Data	West Valley Data		
10N	1991	0.30	41.38	34.45	32.76	7.25E-03	8.71E-03	9.16E-03		
10N	1992	0.17	66.41	43.19	48.63	2.56E-03	3.94E-03	3.50E-03		
10N	1993	-0.58	100.50	39.07	37.35	-5.77E-03	-1.48E-02	-1.55E-02		
10N	1994	0.18	36.83	N / A	40.13	4.89E-03	N / A	4.49E-03		
10S	1986	0.34	41.67	55.12	N / A	8.16E-03	6.17E-03	N / A		
10S	1987	0.00	42.65	37.79	N / A	0.00E+00	0.00E+00	N / A		
10S	1988	0.25	38.15	33.87	N / A	6.55E-03	7.38E-03	N / A		
10S	1989	-1.92	43.79	38.38	N / A	-4.38E-02	-5.00E-02	N / A		
10S	1990	0.83	49.85	48.20	N / A	1.66E-02	1.72E-02	N / A		
10S	1991	1.93	41.38	34.45	32.76	4.67E-02	5.61E-02	5.90E-02		
10S	1992	0.46	66.41	43.19	48.63	6.93E-03	1.07E-02	9.46E-03		
10S	1993	0.32	100.50	39.07	37.35	3.18E-03	8.19E-03	8.57E-03		
10S	1994	0.10	36.83	N / A	40.13	2.72E-03	N / A	2.49E-03		
11	1986	0.17	41.67	55.12	N / A	4.08E-03	3.08E-03	N / A		
11	1987	0.08	42.65	37.79	N / A	1.88E-03	2.12E-03	N / A		
11	1988	0.09	38.15	33.87	N / A	2.36E-03	2.66E-03	N / A		
11	1989	0.25	43.79	38.38	N / A	5.71E-03	6.51E-03	N / A		
11	1990	0.49	49.85	48.20	N / A	9.89E-03	1.02E-02	N / A		

Table 6.7-2. Trench Levels and Precipitation, Years Before Geomembranes Installed										
Trench	Year	Level Change (feet)	Precipitation (inches)			Trench Fill Rate (feet level / inch rain)				
			Buffalo Data	Dunkirk Data	West Valley Data	Buffalo Data	Dunkirk Data	West Valley Data		
11	1991	0.63	41.38	34.45	32.76	1.53E-02	1.84E-02	1.93E-02		
11	1992	0.51	66.41	43.19	48.63	7.68E-03	1.18E-02	1.05E-02		
11	1993	0.20	100.50	39.07	37.35	1.99E-03	5.12E-03	5.35E-03		
11	1994	-0.03	36.83	N / A	40.13	-8.15E-04	N / A	-7.48E-04		
12	1986	0.33	41.67	55.12	N / A	7.92E-03	5.99E-03	N / A		
12	1987	0.84	42.65	37.79	N / A	1.97E-02	2.22E-02	N / A		
12	1988	0.25	38.15	33.87	N / A	6.55E-03	7.38E-03	N / A		
12	1989	0.08	43.79	38.38	N / A	1.83E-03	2.08E-03	N / A		
12	1990	0.17	49.85	48.20	N / A	3.41E-03	3.53E-03	N / A		
12	1991	0.42	41.38	34.45	32.76	1.01E-02	1.22E-02	1.28E-02		
12	1992	0.24	66.41	43.19	48.63	3.61E-03	5.56E-03	4.94E-03		
12	1993	-0.32	100.50	39.07	37.35	-3.18E-03	-8.19E-03	-8.57E-03		
12	1994	0.10	36.83	N / A	40.13	2.72E-03	N / A	2.49E-03		
13	1986	0.00	41.67	55.12	N / A	0.00E+00	0.00E+00	N / A		
13	1987	0.00	42.65	37.79	N / A	0.00E+00	0.00E+00	N / A		
13	1988	0.00	38.15	33.87	N / A	0.00E+00	0.00E+00	N / A		
13	1989	0.00	43.79	38.38	N / A	0.00E+00	0.00E+00	N / A		
13	1990	8.50	49.85	48.20	N / A	1.71E-01	1.76E-01	N / A		

Table 6.7-2. Trench Levels and Precipitation, Years Before Geomembranes Installed										
Trench	Year	Level Change (feet)	Precipitation (inches)			Trench Fill Rate (feet level / inch rain)				
			Buffalo Data	Dunkirk Data	West Valley Data	Buffalo Data	Dunkirk Data	West Valley Data		
13	1991	2.76	41.38	34.45	32.76	6.67E-02	8.01E-02	8.42E-02		
13	1992	1.35	66.41	43.19	48.63	2.03E-02	3.13E-02	2.78E-02		
14	1986	2.67	41.67	55.12	N / A	6.41E-02	4.84E-02	N / A		
14	1987	-0.83	42.65	37.79	N / A	-1.95E-02	-2.20E-02	N / A		
14	1988	0.25	38.15	33.87	N / A	6.55E-03	7.38E-03	N / A		
14	1989	0.17	43.79	38.38	N / A	3.88E-03	4.43E-03	N / A		
14	1990	0.49	49.85	48.20	N / A	9.83E-03	1.02E-02	N / A		
14	1991	0.68	41.38	34.45	32.76	1.65E-02	1.98E-02	2.08E-02		
14	1992	0.63	66.41	43.19	48.63	9.49E-03	1.46E-02	1.30E-02		

Table 6.7-3. 46-Day Precipitation Exceedance

Cumulative Precipitation (inches)	Buffalo Data	Dunkirk Data	West Valley Data
0.2	1.00E+00	1.00E+00	1.00E+00
1.0	9.91E-01	9.98E-01	9.98E-01
2.0	9.32E-01	9.50E-01	9.76E-01
3.0	7.84E-01	8.17E-01	8.62E-01
4.0	5.70E-01	6.09E-01	6.85E-01
5.0	3.72E-01	3.93E-01	4.70E-01
6.0	2.29E-01	2.38E-01	2.68E-01
7.0	1.35E-01	1.39E-01	1.41E-01
8.0	9.17E-02	7.84E-02	5.65E-02
9.0	6.75E-02	4.27E-02	1.65E-02
10.0	5.12E-02	2.68E-02	3.73E-03
11.0	3.88E-02	1.52E-02	6.78E-04
12.0	3.09E-02	7.18E-03	
13.0	2.14E-02	5.22E-03	
14.0	1.64E-02	2.72E-03	
15.0	1.33E-02	1.40E-03	
16.0	9.63E-03	1.89E-04	
16.2	8.59E-03	1.13E-04	
17.0	6.37E-03		
18.0	4.22E-03		
19.0	2.11E-03		
20.0	1.22E-03		
21.0	6.80E-04		
22.0	3.58E-04		
23.0	1.79E-04		
24.0	3.58E-05		

Table 6.7-4. 56-Day Precipitation Exceedance

Cumulative Precipitation (inches)	Buffalo Data	Dunkirk Data	West Valley Data
0.4	1.00E+00	1.00E+00	1.00E+00
1.0	9.97E-01	9.99E-01	1.00E+00
2.0	9.69E-01	9.87E-01	9.93E-01
3.0	8.89E-01	9.21E-01	9.56E-01
4.0	7.47E-01	7.87E-01	8.33E-01
5.0	5.55E-01	5.98E-01	6.91E-01
6.0	3.81E-01	4.07E-01	4.89E-01
7.0	2.52E-01	2.63E-01	3.11E-01
8.0	1.59E-01	1.64E-01	1.69E-01
9.0	1.06E-01	9.71E-02	7.81E-02
10.0	7.94E-02	5.80E-02	3.15E-02
11.0	6.12E-02	3.62E-02	1.30E-02
12.0	4.89E-02	2.14E-02	1.02E-03
12.2	4.71E-02	1.89E-02	1.70E-04
13.0	3.91E-02	1.29E-02	
14.0	3.23E-02	7.76E-03	
15.0	2.54E-02	4.09E-03	
16.0	2.09E-02	2.88E-03	
17.0	1.75E-02	1.40E-03	
18.0	1.36E-02	6.44E-04	
19.0	1.03E-02	1.51E-04	
20.0	6.67E-03		
21.0	4.36E-03		
22.0	2.63E-03		
23.0	1.33E-03		
24.0	9.73E-04		
25.0	5.77E-04		

Table 6.7-4. 56-Day Precipitation Exceedance

Cumulative Precipitation (inches)	Buffalo Data	Dunkirk Data	West Valley Data
26.0	1.44E-04		
26.2	3.61E-05		

Table 6.7-5. 75-Day Precipitation Exceedance

Cumulative Precipitation (inches)	Buffalo Data	Dunkirk Data	West Valley Data
1.0	1.00E+00	9.99E-01	1.00E+00
2.0	9.94E-01	9.98E-01	1.00E+00
3.0	9.69E-01	9.90E-01	9.98E-01
4.0	9.19E-01	9.53E-01	9.83E-01
5.0	8.27E-01	8.68E-01	9.01E-01
6.0	6.75E-01	7.21E-01	7.92E-01
7.0	5.19E-01	5.64E-01	6.67E-01
8.0	3.81E-01	4.16E-01	5.04E-01
9.0	2.73E-01	2.85E-01	3.39E-01
10.0	1.87E-01	1.91E-01	2.07E-01
11.0	1.37E-01	1.25E-01	1.16E-01
12.0	1.03E-01	8.41E-02	6.07E-02
13.0	7.98E-02	5.63E-02	2.68E-02
14.0	6.23E-02	3.50E-02	1.36E-02
15.0	5.10E-02	2.30E-02	3.27E-03
16.0	4.38E-02	1.45E-02	1.72E-04
17.0	3.81E-02	1.03E-02	
18.0	3.39E-02	6.67E-03	
19.0	3.05E-02	3.64E-03	
20.0	2.70E-02	1.67E-03	
21.0	2.31E-02	1.21E-03	
22.0	1.97E-02	8.71E-04	
23.0	1.70E-02	4.92E-04	
24.0	1.40E-02	3.79E-05	
25.0	9.08E-03		
26.0	6.29E-03		
27.0	4.01E-03		

Table 6.7-5. 75-Day Precipitation Exceedance

Cumulative Precipitation (inches)	Buffalo Data	Dunkirk Data	West Valley Data
28.0	1.95E-03		
29.0	8.82E-04		
30.0	2.94E-04		
31.0	2.21E-04		
32.0	7.35E-05		

Table 6.7-6. 91-Day Precipitation Exceedance

Cumulative Precipitation (inches)	Buffalo Data	Dunkirk Data	West Valley Data
1.4	1.00E+00	1.00E+00	1.00E+00
2.0	9.99E-01	9.99E-01	1.00E+00
3.0	9.88E-01	9.98E-01	1.00E+00
4.0	9.66E-01	9.91E-01	9.99E-01
5.0	9.24E-01	9.59E-01	9.90E-01
6.0	8.49E-01	8.94E-01	9.28E-01
7.0	7.33E-01	7.80E-01	8.34E-01
8.0	5.89E-01	6.44E-01	7.27E-01
9.0	4.64E-01	5.14E-01	6.04E-01
10.0	3.56E-01	3.81E-01	4.74E-01
11.0	2.58E-01	2.69E-01	3.25E-01
12.0	1.89E-01	1.86E-01	1.99E-01
13.0	1.43E-01	1.31E-01	1.30E-01
14.0	1.14E-01	8.96E-02	6.67E-02
15.0	9.04E-02	6.09E-02	3.44E-02
16.0	7.18E-02	4.40E-02	1.57E-02
17.0	5.90E-02	3.02E-02	7.26E-03
18.0	5.05E-02	2.02E-02	2.42E-03
18.6	4.65E-02	1.63E-02	3.46E-04
19.0	4.44E-02	1.44E-02	
20.0	4.03E-02	1.04E-02	
21.0	3.60E-02	6.95E-03	
22.0	3.35E-02	2.62E-03	
23.0	3.18E-02	1.56E-03	
24.0	2.88E-02	1.29E-03	
25.0	2.53E-02	1.25E-03	
26.0	2.27E-02	1.14E-04	

Table 6.7-6. 91-Day Precipitation Exceedance

Cumulative Precipitation (inches)	Buffalo Data	Dunkirk Data	West Valley Data
27.0	2.00E-02		
28.0	1.50E-02		
29.0	1.10E-02		
30.0	6.19E-03		
31.0	3.84E-03		
32.0	2.20E-03		
33.0	1.90E-03		
34.0	1.42E-03		
35.0	5.60E-04		
36.0	3.73E-05		

Table 6.7-7. 112-Day Precipitation Exceedance

Cumulative Precipitation (inches)	Buffalo Data	Dunkirk Data	West Valley Data
2.6	1.00E+00	1.00E+00	1.00E+00
3.0	9.97E-01	1.00E+00	1.00E+00
4.0	9.88E-01	9.98E-01	1.00E+00
5.0	9.71E-01	9.95E-01	1.00E+00
6.0	9.40E-01	9.78E-01	9.97E-01
7.0	8.94E-01	9.37E-01	9.68E-01
8.0	8.14E-01	8.68E-01	9.04E-01
9.0	7.14E-01	7.65E-01	8.19E-01
10.0	5.88E-01	6.53E-01	7.29E-01
11.0	4.82E-01	5.30E-01	6.22E-01
12.0	3.79E-01	4.09E-01	5.08E-01
13.0	2.88E-01	2.96E-01	3.70E-01
14.0	2.19E-01	2.20E-01	2.67E-01
15.0	1.73E-01	1.66E-01	1.87E-01
16.0	1.35E-01	1.15E-01	1.05E-01
17.0	1.12E-01	8.43E-02	5.43E-02
18.0	9.38E-02	6.04E-02	3.06E-02
19.0	7.88E-02	4.55E-02	2.02E-02
20.0	6.60E-02	3.25E-02	8.88E-03
21.0	5.64E-02	2.34E-02	5.22E-03
22.0	4.96E-02	1.74E-02	5.22E-04
22.6	4.74E-02	1.37E-02	3.48E-04
23.0	4.60E-02	1.18E-02	
24.0	4.24E-02	7.77E-03	
25.0	4.08E-02	5.03E-03	
26.0	3.88E-02	3.09E-03	
27.0	3.65E-02	2.17E-03	

Table 6.7-7. 112-Day Precipitation Exceedance

Cumulative Precipitation (inches)	Buffalo Data	Dunkirk Data	West Valley Data
28.0	3.41E-02	1.03E-03	
29.0	3.11E-02	2.29E-04	
30.0	2.77E-02	1.14E-04	
31.0	2.35E-02		
32.0	1.74E-02		
33.0	1.47E-02		
34.0	1.22E-02		
35.0	8.72E-03		
36.0	5.29E-03		
37.0	3.58E-03		
38.0	2.85E-03		
39.0	2.55E-03		
40.0	1.75E-03		
41.0	9.90E-04		
42.0	2.28E-04		

Cumulative Precipitation (inches)	Buffalo Data	Dunkirk Data	West Valley Data
3.4	1.00E+00	1.00E+00	1.00E+00
4.0	9.98E-01	1.00E+00	1.00E+00
5.0	9.94E-01	1.00E+00	1.00E+00
6.0	9.91E-01	1.00E+00	1.00E+00
7.0	9.76E-01	9.99E-01	1.00E+00
8.0	9.52E-01	9.93E-01	1.00E+00
9.0	9.24E-01	9.75E-01	9.93E-01
10.0	8.90E-01	9.34E-01	9.67E-01
11.0	8.28E-01	8.84E-01	9.26E-01
12.0	7.52E-01	8.14E-01	8.54E-01
13.0	6.52E-01	7.30E-01	7.78E-01
14.0	5.66E-01	6.24E-01	6.96E-01
15.0	4.69E-01	5.13E-01	6.03E-01
16.0	3.82E-01	4.09E-01	5.14E-01
17.0	3.08E-01	3.18E-01	4.17E-01
18.0	2.44E-01	2.44E-01	3.19E-01
19.0	1.98E-01	1.84E-01	2.41E-01
20.0	1.63E-01	1.38E-01	1.55E-01
21.0	1.39E-01	1.12E-01	8.70E-02
22.0	1.18E-01	8.34E-02	5.80E-02
23.0	1.02E-01	6.26E-02	4.27E-02
24.0	8.94E-02	4.73E-02	2.84E-02
25.0	7.82E-02	3.65E-02	1.71E-02
26.0	6.90E-02	2.91E-02	9.88E-03
27.0	6.32E-02	2.16E-02	4.23E-03
28.0	5.89E-02	1.44E-02	
29.0	5.49E-02	9.96E-03	

Table 6.7-8. 150-Day Precipitation Exceedance

Cumulative Precipitation (inches)	Buffalo Data	Dunkirk Data	West Valley Data
30.0	5.38E-02	8.08E-03	
31.0	5.25E-02	5.86E-03	
32.0	5.02E-02	3.14E-03	
33.0	4.83E-02	2.53E-03	
34.0	4.70E-02	1.80E-03	
35.0	4.34E-02	5.75E-04	
36.0	3.80E-02	3.45E-04	
37.0	3.03E-02		
38.0	2.59E-02		
39.0	2.29E-02		
40.0	2.06E-02		
41.0	1.78E-02		
42.0	1.50E-02		
43.0	1.11E-02		
44.0	9.44E-03		
45.0	7.82E-03		
46.0	6.71E-03		
47.0	5.73E-03		
48.0	4.74E-03		
49.0	3.67E-03		
50.0	3.00E-03		
51.0	1.74E-03		
52.0	1.26E-03		
53.0	3.55E-04		
54.0	1.97E-04		
55.0	7.90E-05		

Table 6.7-9. 196-Day Precipitation Exceedance			
Cumulative Precipitation (inches)	Buffalo Data	Dunkirk Data	West Valley Data
5.4	1.00E+00	1.00E+00	1.00E+00
6.0	9.98E-01	1.00E+00	1.00E+00
7.0	9.98E-01	1.00E+00	1.00E+00
8.0	9.92E-01	1.00E+00	1.00E+00
9.0	9.83E-01	1.00E+00	1.00E+00
10.0	9.75E-01	1.00E+00	1.00E+00
11.0	9.58E-01	9.97E-01	1.00E+00
12.0	9.30E-01	9.83E-01	9.99E-01
13.0	9.01E-01	9.58E-01	9.89E-01
14.0	8.75E-01	9.30E-01	9.58E-01
15.0	8.29E-01	8.93E-01	9.18E-01
16.0	7.69E-01	8.42E-01	8.88E-01
17.0	6.98E-01	7.77E-01	8.25E-01
18.0	6.17E-01	6.91E-01	7.53E-01
19.0	5.29E-01	5.93E-01	6.78E-01
20.0	4.55E-01	5.02E-01	6.07E-01
21.0	3.84E-01	4.06E-01	5.28E-01
22.0	3.10E-01	3.14E-01	4.54E-01
23.0	2.56E-01	2.44E-01	3.59E-01
24.0	2.21E-01	1.89E-01	2.48E-01
25.0	1.88E-01	1.51E-01	1.77E-01
26.0	1.61E-01	1.21E-01	1.22E-01
27.0	1.37E-01	1.00E-01	8.14E-02
28.0	1.19E-01	8.00E-02	5.42E-02
29.0	1.07E-01	5.97E-02	4.27E-02
30.0	9.69E-02	4.55E-02	2.99E-02
31.0	8.94E-02	3.66E-02	1.90E-02

Table 6.7-9. 196-Day Precipitation Exceedance

Cumulative Precipitation (inches)	Buffalo Data	Dunkirk Data	West Valley Data
32.0	8.23E-02	2.86E-02	1.27E-02
33.0	7.65E-02	2.14E-02	3.77E-03
34.0	7.22E-02	1.53E-02	
35.0	6.82E-02	1.21E-02	
36.0	6.66E-02	9.45E-03	
37.0	6.55E-02	6.52E-03	
38.0	6.47E-02	4.51E-03	
39.0	6.32E-02	2.74E-03	
40.0	6.02E-02	2.47E-03	
41.0	5.73E-02	2.08E-03	
42.0	5.23E-02	1.85E-03	
43.0	4.88E-02	8.49E-04	
44.0	4.50E-02		
45.0	4.07E-02		
46.0	3.85E-02		
47.0	3.43E-02		
48.0	3.09E-02		
49.0	2.78E-02		
50.0	2.31E-02		
51.0	1.85E-02		
52.0	1.53E-02		
53.0	1.22E-02		
54.0	1.01E-02		
55.0	8.77E-03		
56.0	7.36E-03		
57.0	6.45E-03		
58.0	5.54E-03		

Table 6.7-9. 196-Day Precipitation Exceedance			
Cumulative Precipitation (inches)	Buffalo Data	Dunkirk Data	West Valley Data
59.0	4.96E-03		
60.0	4.76E-03		
61.0	4.47E-03		
62.0	3.64E-03		
63.0	3.10E-03		
64.0	2.48E-03		
65.0	2.23E-03		
66.0	2.15E-03		
67.0	1.57E-03		
68.0	1.20E-03		
69.0	2.48E-04		

Table 6.7-10. 252-Day Precipitation Exceedance

Cumulative Precipitation (inches)	Buffalo Data	Dunkirk Data	West Valley Data
8.2	1.00E+00	1.00E+00	1.00E+00
9.0	9.99E-01	1.00E+00	1.00E+00
10.0	9.94E-01	1.00E+00	1.00E+00
11.0	9.89E-01	1.00E+00	1.00E+00
12.0	9.86E-01	1.00E+00	1.00E+00
13.0	9.84E-01	1.00E+00	1.00E+00
14.0	9.77E-01	1.00E+00	1.00E+00
15.0	9.55E-01	9.98E-01	1.00E+00
16.0	9.34E-01	9.91E-01	1.00E+00
17.0	9.14E-01	9.75E-01	9.94E-01
18.0	8.90E-01	9.57E-01	9.78E-01
19.0	8.59E-01	9.36E-01	9.54E-01
20.0	8.19E-01	9.04E-01	9.34E-01
21.0	7.70E-01	8.58E-01	8.97E-01
22.0	7.18E-01	8.08E-01	8.66E-01
23.0	6.64E-01	7.42E-01	8.23E-01
24.0	6.03E-01	6.66E-01	7.68E-01
25.0	5.28E-01	5.68E-01	7.02E-01
26.0	4.45E-01	4.76E-01	6.28E-01
27.0	3.92E-01	3.99E-01	5.59E-01
28.0	3.40E-01	3.22E-01	4.76E-01
29.0	2.96E-01	2.60E-01	3.88E-01
30.0	2.55E-01	2.12E-01	2.83E-01
31.0	2.22E-01	1.75E-01	2.13E-01
32.0	1.89E-01	1.44E-01	1.52E-01
33.0	1.58E-01	1.21E-01	1.03E-01
34.0	1.38E-01	9.57E-02	6.99E-02

Table 6.7-10. 252-Day Precipitation Exceedance

Cumulative Precipitation (inches)	Buffalo Data	Dunkirk Data	West Valley Data
35.0	1.24E-01	7.84E-02	4.92E-02
36.0	1.15E-01	6.22E-02	4.17E-02
37.0	1.04E-01	4.43E-02	2.76E-02
38.0	9.70E-02	3.19E-02	1.65E-02
39.0	9.32E-02	2.43E-02	9.70E-03
40.0	8.92E-02	1.88E-02	2.38E-03
41.0	8.64E-02	1.44E-02	
42.0	8.46E-02	1.09E-02	
43.0	8.26E-02	8.29E-03	
44.0	8.15E-02	7.47E-03	
45.0	7.98E-02	5.88E-03	
46.0	7.88E-02	3.70E-03	
47.0	7.81E-02	3.19E-03	
48.0	7.60E-02	2.14E-03	
49.0	7.23E-02	8.17E-04	
50.0	6.79E-02	2.34E-04	
51.0	6.48E-02	1.56E-04	
52.0	6.19E-02		
53.0	5.73E-02		
54.0	5.35E-02		
55.0	5.07E-02		
56.0	4.69E-02		
57.0	4.29E-02		
58.0	3.93E-02		
59.0	3.65E-02		
60.0	3.27E-02		
61.0	2.85E-02		

Table 6.7-10. 252-Day Precipitation Exceedance

Cumulative Precipitation (inches)	Buffalo Data	Dunkirk Data	West Valley Data
62.0	2.60E-02		
63.0	2.22E-02		
64.0	1.94E-02		
65.0	1.76E-02		
66.0	1.42E-02		
67.0	9.83E-03		
68.0	8.25E-03		
69.0	7.16E-03		
70.0	5.84E-03		
71.0	5.14E-03		
72.0	5.01E-03		
73.0	4.92E-03		
74.0	4.74E-03		
75.0	4.61E-03		
76.0	4.48E-03		
77.0	4.13E-03		
78.0	3.91E-03		
79.0	3.25E-03		
80.0	2.50E-03		
81.0	1.93E-03		
82.0	1.71E-03		
83.0	1.45E-03		
84.0	4.83E-04		

Table 6.7-11. 356-Day Precipitation Exceedance

Cumulative Precipitation (inches)	Buffalo Data	Dunkirk Data	West Valley Data
14.4	1.00E+00	1.00E+00	1.00E+00
15.0	9.99E-01	1.00E+00	1.00E+00
16.0	9.98E-01	1.00E+00	1.00E+00
17.0	9.97E-01	1.00E+00	1.00E+00
18.0	9.94E-01	1.00E+00	1.00E+00
19.0	9.94E-01	1.00E+00	1.00E+00
20.0	9.92E-01	1.00E+00	1.00E+00
21.0	9.90E-01	1.00E+00	1.00E+00
22.0	9.85E-01	1.00E+00	1.00E+00
23.0	9.75E-01	9.99E-01	1.00E+00
24.0	9.53E-01	9.95E-01	1.00E+00
25.0	9.22E-01	9.89E-01	9.98E-01
26.0	8.98E-01	9.79E-01	9.93E-01
27.0	8.77E-01	9.67E-01	9.86E-01
28.0	8.53E-01	9.50E-01	9.71E-01
29.0	8.22E-01	9.25E-01	9.56E-01
30.0	7.88E-01	8.98E-01	9.41E-01
31.0	7.50E-01	8.65E-01	9.20E-01
32.0	7.13E-01	8.22E-01	9.05E-01
33.0	6.71E-01	7.63E-01	8.75E-01
34.0	6.26E-01	6.89E-01	8.53E-01
35.0	5.84E-01	6.15E-01	8.22E-01
36.0	5.39E-01	5.45E-01	7.75E-01
37.0	4.91E-01	4.63E-01	7.10E-01
38.0	4.41E-01	3.97E-01	6.41E-01
39.0	4.01E-01	3.41E-01	5.49E-01
40.0	3.59E-01	2.90E-01	4.67E-01

Table 6.7-11. 356-Day Precipitation Exceedance

Cumulative Precipitation (inches)	Buffalo Data	Dunkirk Data	West Valley Data
41.0	3.18E-01	2.46E-01	3.83E-01
42.0	2.81E-01	2.10E-01	3.07E-01
43.0	2.48E-01	1.83E-01	2.34E-01
44.0	2.15E-01	1.58E-01	1.64E-01
45.0	1.84E-01	1.32E-01	9.17E-02
46.0	1.65E-01	1.03E-01	4.76E-02
47.0	1.48E-01	7.52E-02	2.40E-02
48.0	1.36E-01	5.68E-02	1.88E-02
49.0	1.24E-01	4.44E-02	7.80E-03
50.0	1.17E-01	3.81E-02	
51.0	1.15E-01	3.18E-02	
52.0	1.11E-01	2.25E-02	
53.0	1.09E-01	1.65E-02	
54.0	1.09E-01	1.44E-02	
55.0	1.07E-01	1.09E-02	
56.0	1.06E-01	8.98E-03	
57.0	1.04E-01	6.88E-03	
58.0	1.04E-01	4.55E-03	
59.0	1.02E-01	1.94E-03	
60.0	9.97E-02	8.31E-04	
61.0	9.87E-02	4.35E-04	
62.0	9.70E-02		
63.0	9.62E-02		
64.0	9.45E-02		
65.0	8.92E-02		
66.0	8.67E-02		
67.0	8.48E-02		

Table 6.7-11. 356-Day Precipitation Exceedance

Cumulative Precipitation (inches)	Buffalo Data	Dunkirk Data	West Valley Data
68.0	8.25E-02		
69.0	7.84E-02		
70.0	7.54E-02		
71.0	7.32E-02		
72.0	7.05E-02		
73.0	6.85E-02		
74.0	6.64E-02		
75.0	6.23E-02		
76.0	5.77E-02		
77.0	5.35E-02		
78.0	5.03E-02		
79.0	4.60E-02		
80.0	4.41E-02		
81.0	4.24E-02		
82.0	3.84E-02		
83.0	3.35E-02		
84.0	2.92E-02		
85.0	2.65E-02		
86.0	2.41E-02		
87.0	2.16E-02		
88.0	1.99E-02		
89.0	1.77E-02		
90.0	1.61E-02		
91.0	1.52E-02		
92.0	1.37E-02		
93.0	1.22E-02		
94.0	1.07E-02		

Table 6.7-11. 356-Day Precipitation Exceedance

Cumulative Precipitation (inches)	Buffalo Data	Dunkirk Data	West Valley Data
95.0	1.00E-02		
96.0	9.09E-03		
97.0	7.64E-03		
98.0	4.74E-03		
99.0	2.22E-03		
100.0	9.19E-04		
101.0	5.32E-04		
102.0	1.45E-04		

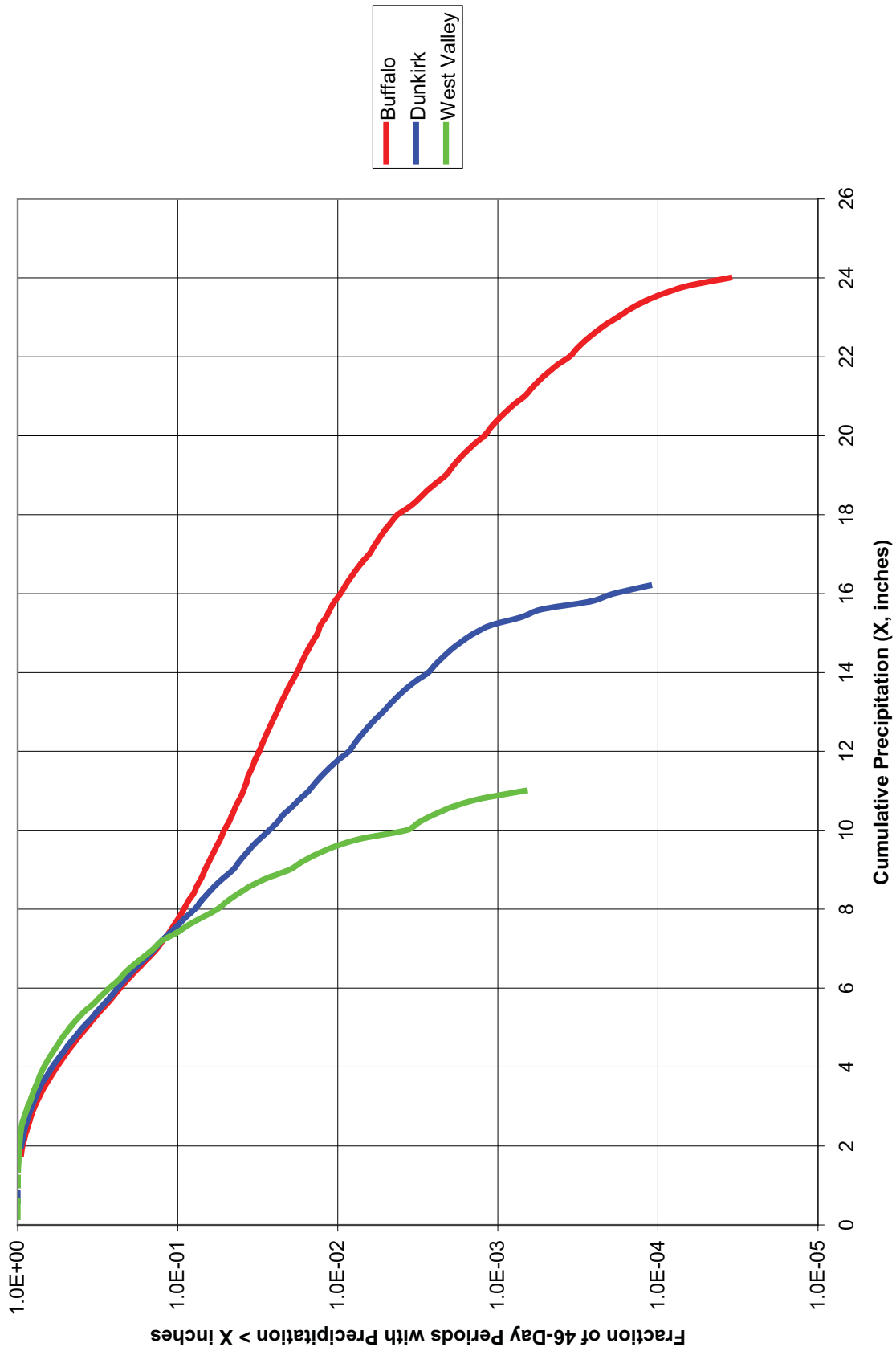

Figure 6.7-1. 46-Day Precipitation Exceedance Curves

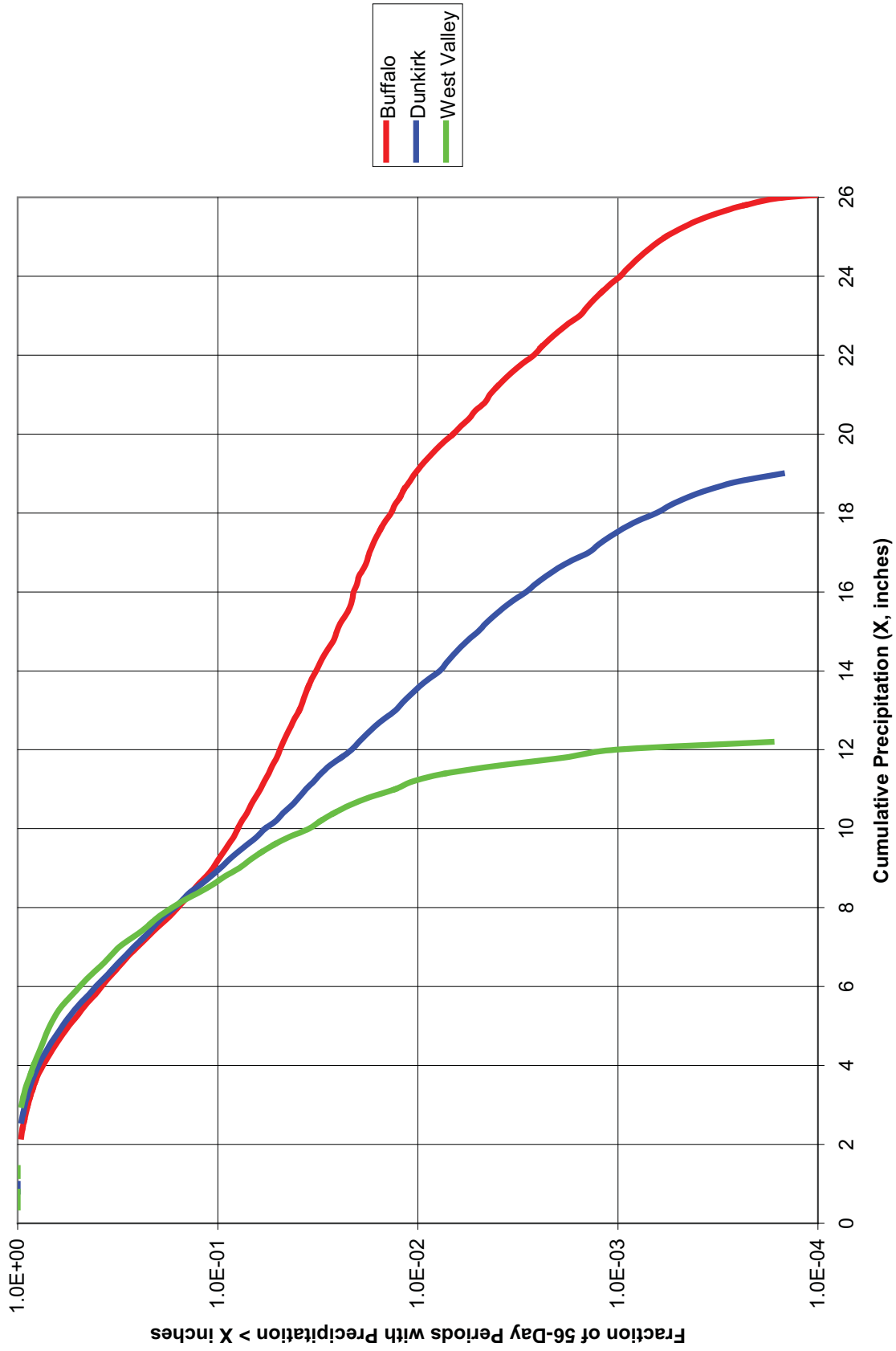

Figure 6.7-2. 56-Day Precipitation Exceedance Curves

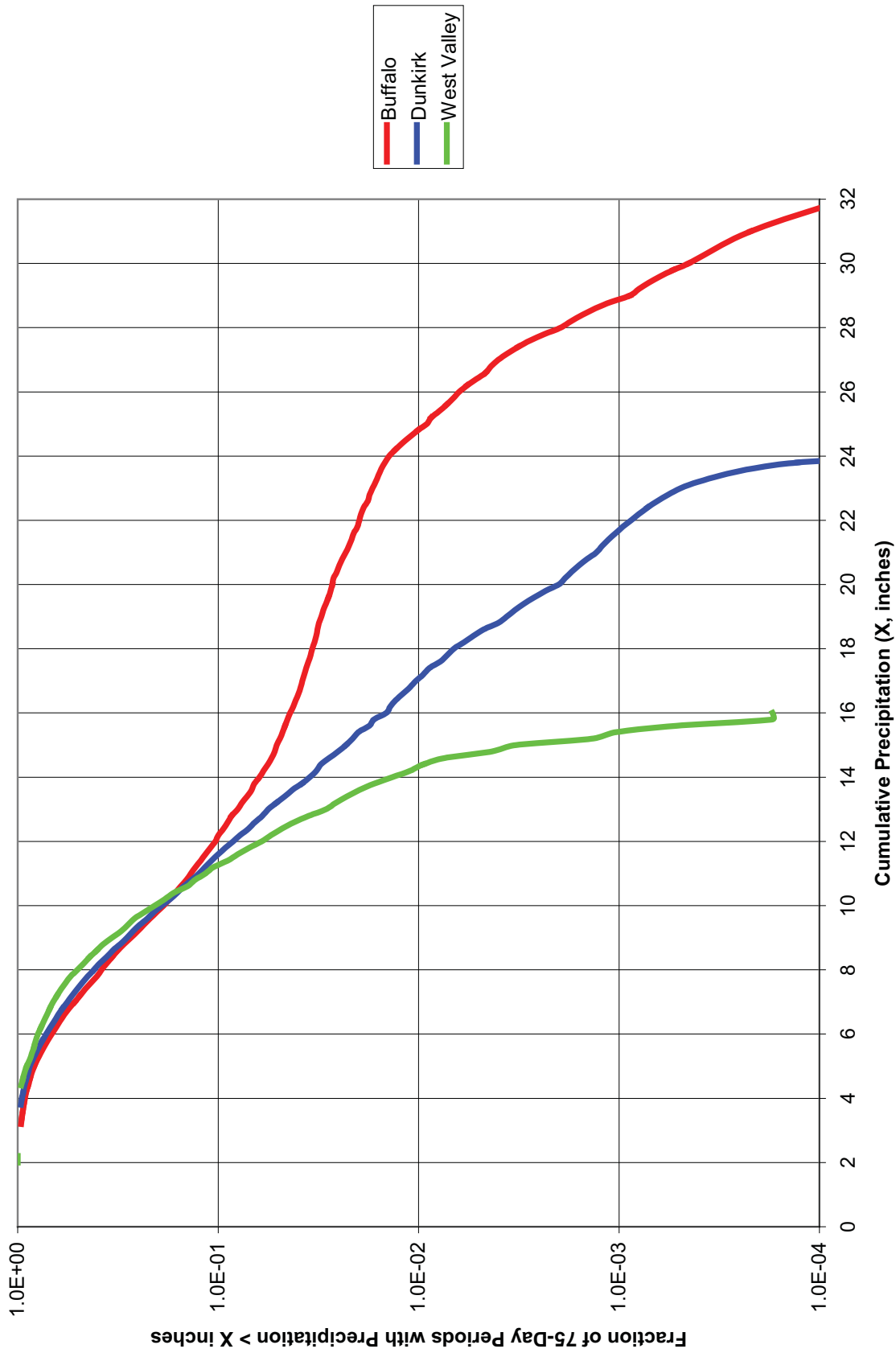

Figure 6.7-3. 75-Day Precipitation Exceedance Curves

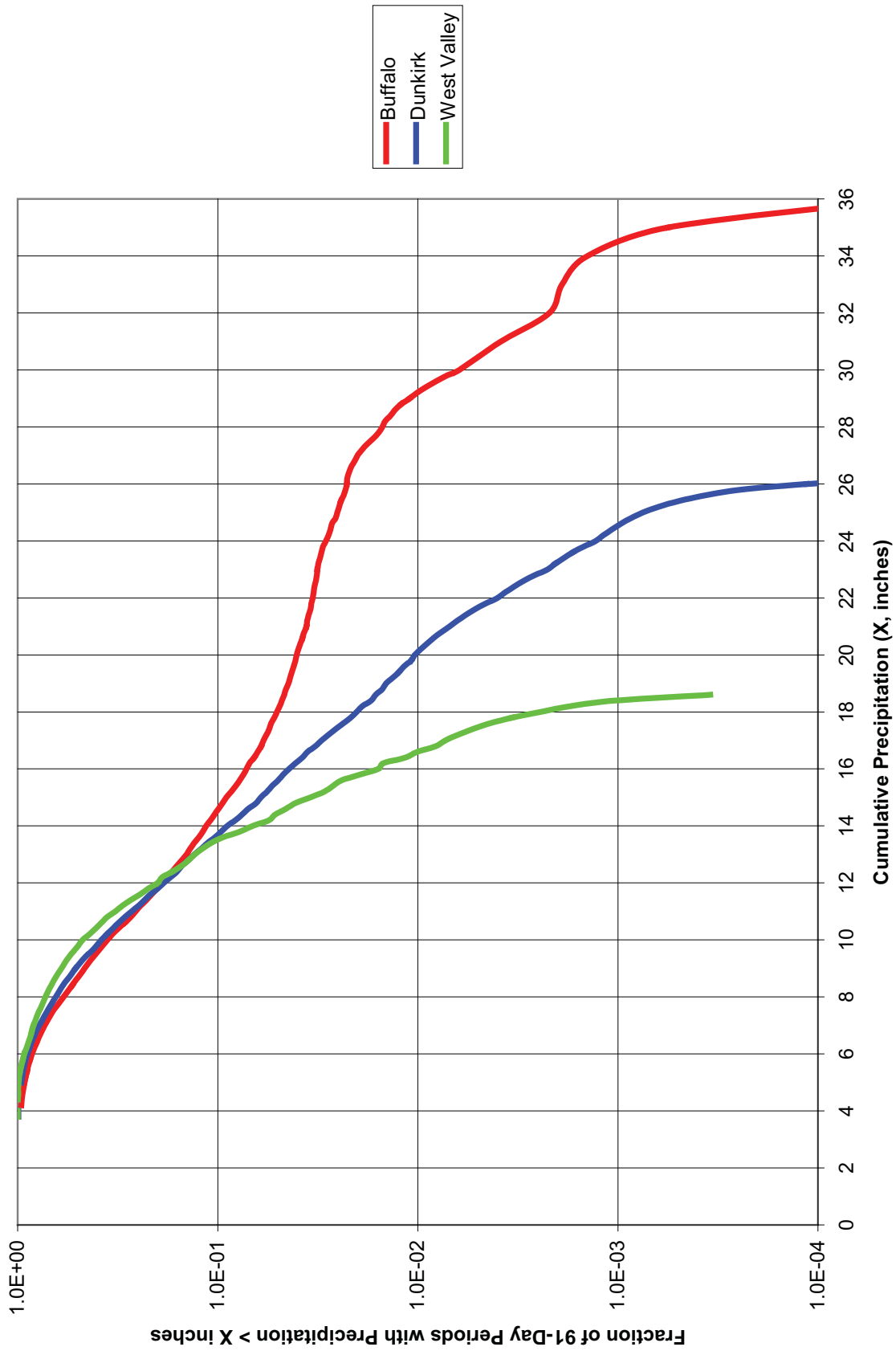

Figure 6.7-4. 91-Day Precipitation Exceedance Curves

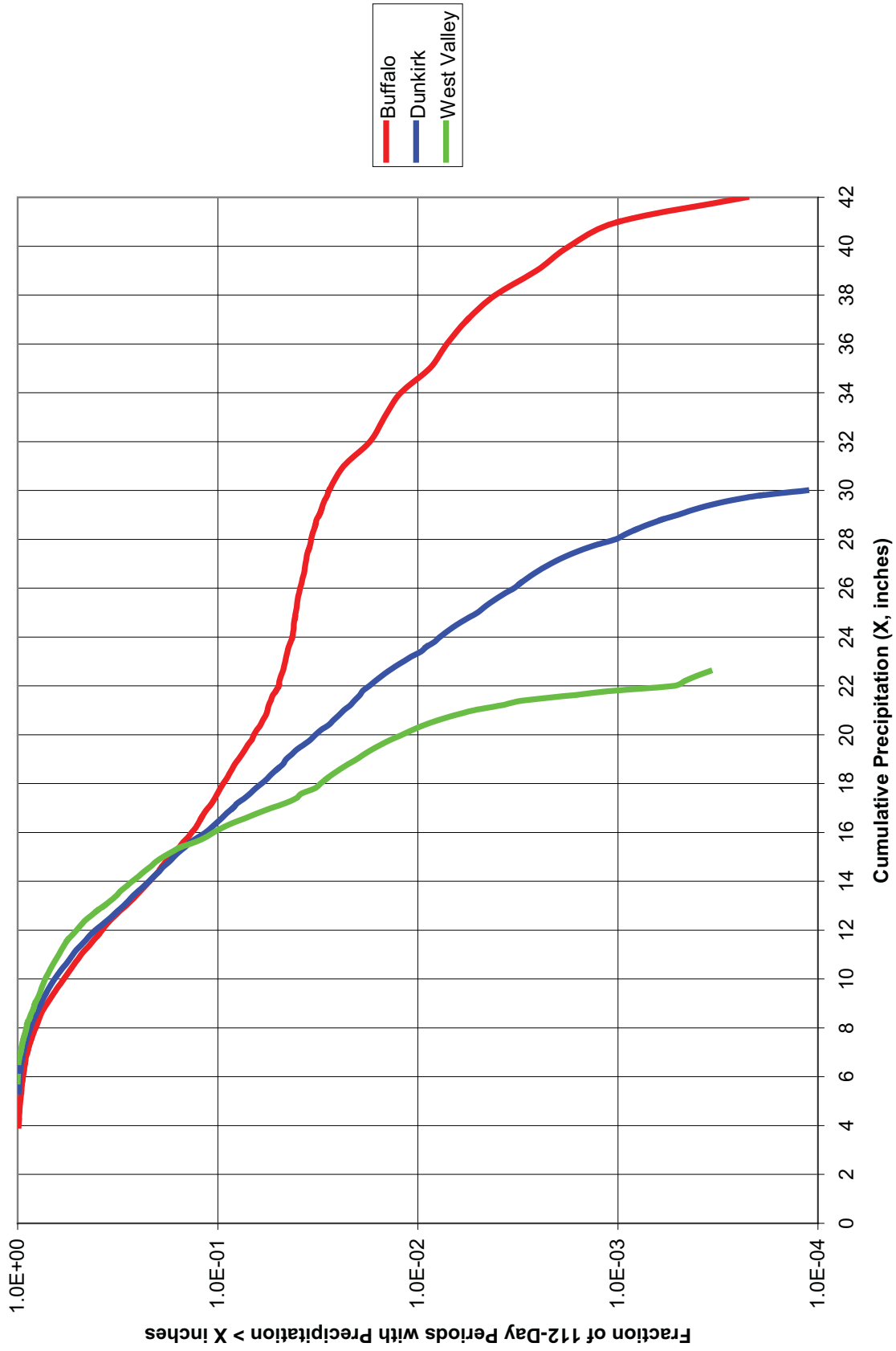

Figure 6.7-5. 112-Day Precipitation Exceedance Curves

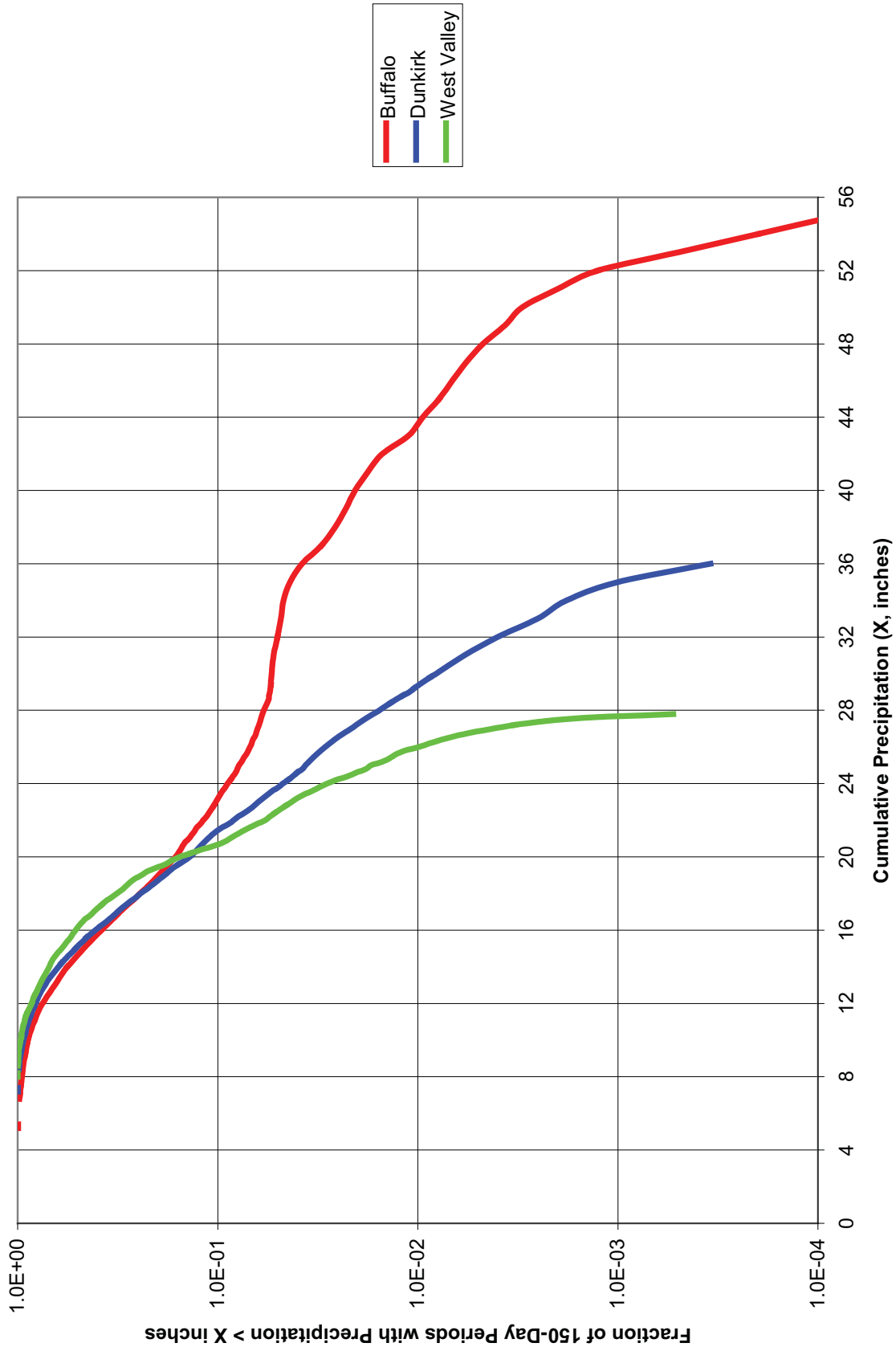

Figure 6.7-6. 150-Day Precipitation Exceedance Curves

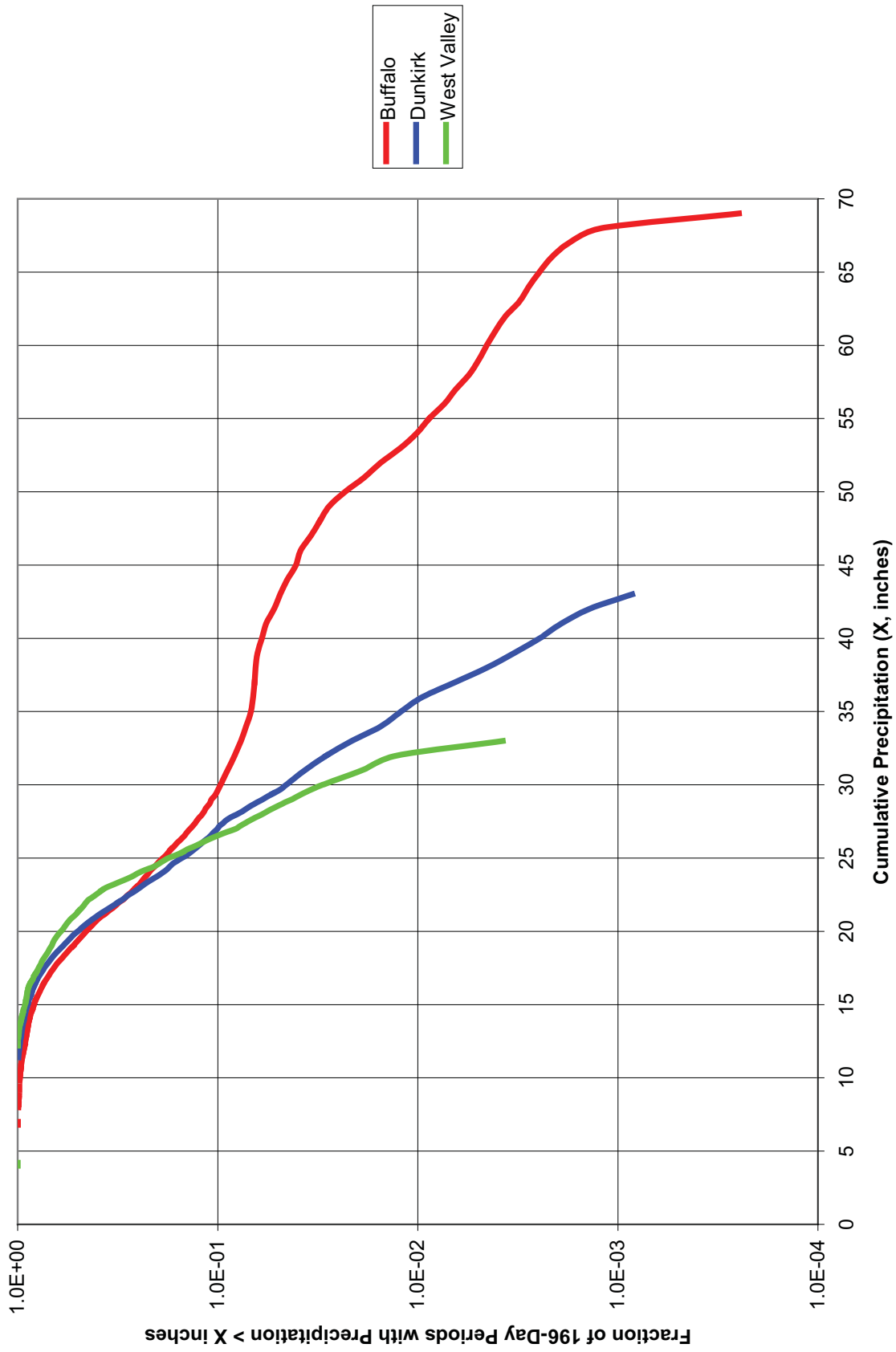

Figure 6.7-7. 196-Day Precipitation Exceedance Curves

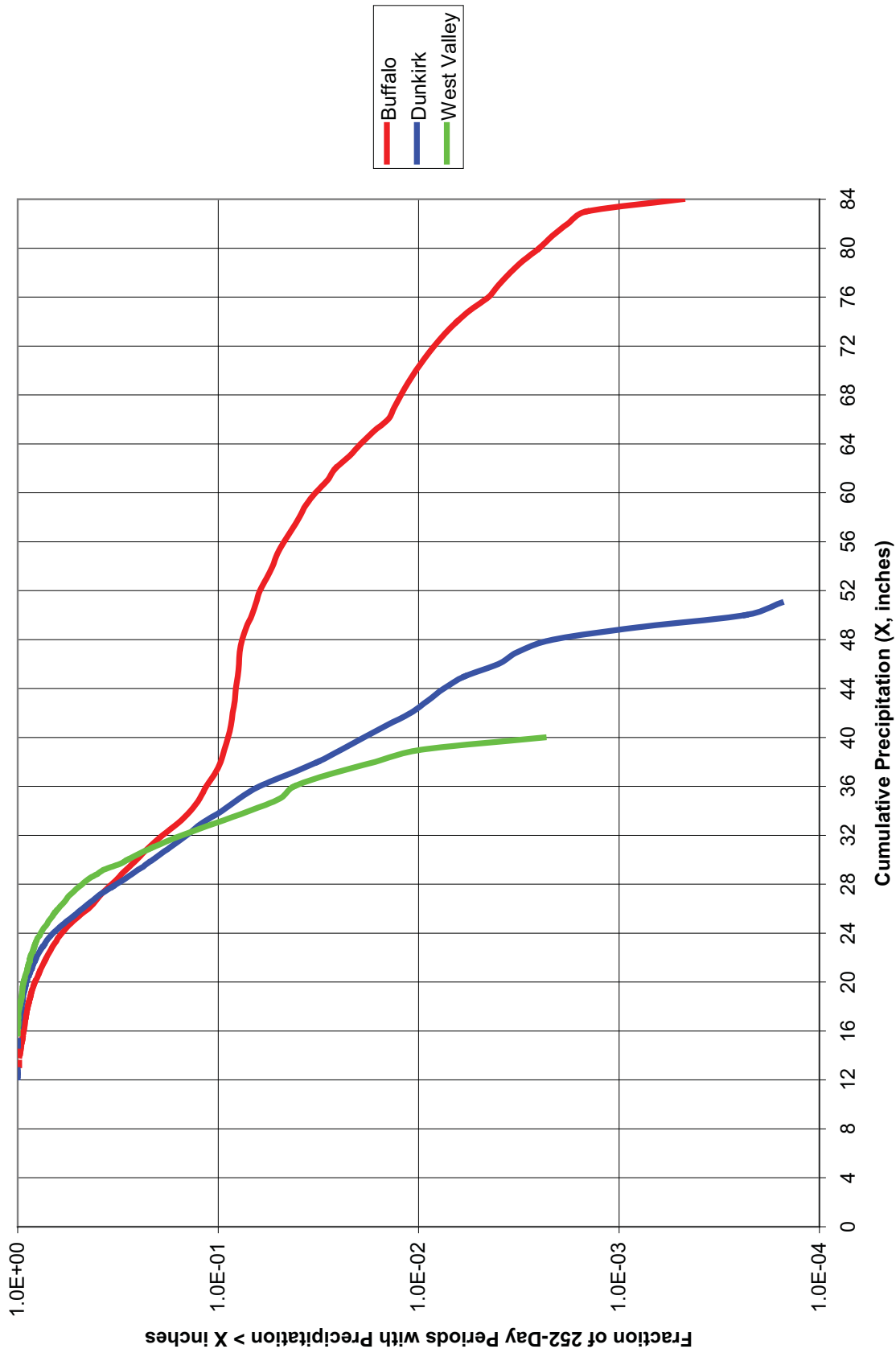

Figure 6.7-8. 252-Day Precipitation Exceedance Curves

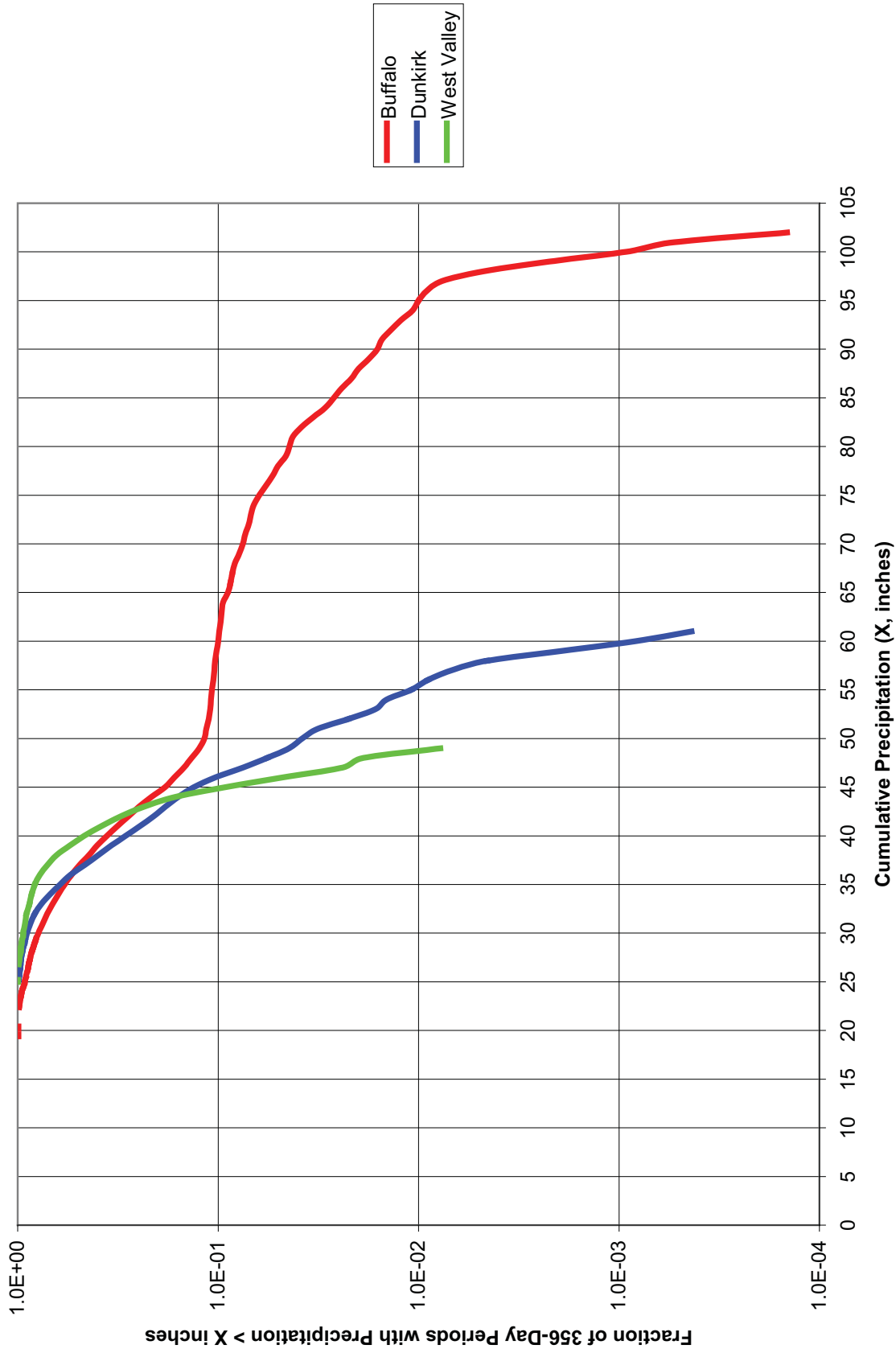

Figure 6.7-9. 356-Day Precipitation Exceedance Curves

SECTION 7

MITIGATION SYSTEMS ANALYSIS

This section documents analyses that were performed to evaluate the effectiveness of the SDA engineered barriers and selected event mitigation options. Section 7.1 summarizes assessments of potential intervention and mitigation responses that may prevent releases from the waste trenches or stop a continuing release into the surrounding environment. Section 7.2 evaluates conditions that affect the availability of the geomembrane covers over the 30-year risk assessment time period. Section 7.3 documents the analyses of storms that may severely erode the compacted clay caps over the waste trenches.

7.1 MITIGATION RESPONSES

The SDA risk assessment includes credit for NYSERDA responses to intervene and mitigate the potential consequences from a variety of adverse conditions. The scope of this study is limited to the evaluation of mitigation responses that prevent releases from the trenches or stop a continuing release into the surrounding environment. The study does not explicitly evaluate additional possible measures that could affect dispersal of the materials after they are released into the stream systems or reduce potential doses to the study receptors (e.g., by retention or diversion of stream flows, removal of contaminated materials, relocation of receptors, etc.).

The study assumes that the credited mitigation responses will achieve their intended goals. However, there is substantial uncertainty about the amount of time that may be required for NYSERDA engineers to identify the specific problem, diagnose the cause, determine the most appropriate solution, and implement that solution. These mitigation times may affect the SDA vulnerability to specific threats, or they may affect the amount of radioactive material that enters the environment before a release is effectively terminated.

To best account for the NYSERDA team's experience and their understanding of the integrated mitigation requirements, the team was asked to evaluate several SDA damage scenarios. In particular, they were asked to describe the activities that are necessary to achieve the desired mitigation goal for each scenario and to provide "best", "upper bound", and "lower bound" estimates for the amount of time that may be required to complete each phase of the mitigation plan. The following sections document the scenarios and the NYSERDA evaluations (References 7.1-1 and 7.1-2).

7.1.1 Scenario 1 – Aircraft Crash

Scenario 1 – A large commercial aircraft crashes into the site, destroying the geomembranes and causing significant damage to the trenches and the ground surface.

The NYSERDA team broke the response to this scenario into four phases as described below:

Phase 1 – Crash Investigation / Airplane Debris Cleanup – NYSERDA does not have specific expertise in the investigation and cleanup of commercial aircraft accidents. We assumed that this airline crash was large enough to mobilize the federal and state emergency responders, including the investigative branch of the Federal Aviation Administration. Based upon this limited knowledge, our “best estimate” for the response, investigation and cleanup would be 2 weeks. We suggest that more research be conducted, other experts contacted, to provide a better estimate.

Phase 2 – Assessment and Design – Within days of the accident, NYSERDA would mobilize its on-call contractor(s) to assess the damage to the SDA. This would include field investigations. The engineering contractor, in consultation with NYSERDA, would put together a design for re-grading / re-shaping the damaged trenches and replacing the geomembrane cover. Completion of the assessment and design is “best” estimated at 4 weeks.

Phase 3 – Re-grading / Re-shaping the Damaged Trenches – Field work would commence upon approval of the plan. It is anticipated that sections of the damaged trenches would be

grouted. Our “best” estimate is that this phase would take 16 weeks from the time of completion of the design.

Phase 4 – Installing Geomembrane Cover Over the Damaged Trenches – Based upon the design from NYSERDA’s engineering contractor, NYSERDA could order the replacement geomembrane cover. As this is not an off-the-shelf item, it is anticipated to take 16 weeks to manufacture. The installation of the cover would take about another 16 weeks, so our “best” estimate for this phase is 32 weeks from completion of the design.

Phase	Lower Bound Time	"Best" Estimate Time	Upper Bound Time
1 – Crash Investigation / Airplane Debris Cleanup ⁽¹⁾	7 days	14 days	56 days
2 – Assessment and Design	14 days	28 days	56 days
3 – Re-grading / Re-shaping the Damaged Trenches ⁽²⁾	56 days	112 days	182 days
4 – Installing Geomembrane Cover Over the Damaged Trenches	182 days	224 days	300 days
Total Time for Scenario to be Completed	196 days	252 days	356 days

(1) Work takes place simultaneously with Phase 2

(2) Work takes place simultaneously with Phase 4

7.1.2 Scenario 2 – Tornado

***Scenario 2** – A severe tornado strikes the site, destroying the geomembranes, but not disturbing the trench caps.*

This scenario would involve a response similar to Scenario 1, without the crash investigation and airplane debris cleanup.

Phase 1 – Assessment, Design and Cleanup – Within a few days of the tornado, NYSERDA would mobilize its on-call contractor(s) to assess the damage to the SDA (of which it is assumed to be little). This would include a field investigation and cleanup of any debris from the storm. The engineering contractor, in consultation with NYSERDA, would put together a design for replacing the geomembrane cover. Completion of this phase is “best” estimated at 4 weeks.

Phase 2 – Installing Geomembrane Cover – Based upon the design from NYSERDA’s engineering contractor, NYSERDA could order the replacement geomembrane cover. As this is not an off-the-shelf item, it is anticipated to take 16 weeks to manufacture. The installation of the cover would take about another 16 weeks, so our “best” estimate for this phase is 32 weeks from the time of the accident.

Phase	Lower Bound Time	"Best" Estimate Time	Upper Bound Time
1 – Assessment, Design and Cleanup	14 days	28 days	56 days
2 – Installing Geomembrane Cover	182 days	224 days	300 days
Total Time for Scenario to be Completed	196 days	252 days	356 days

7.1.3 Scenario 3 – Earthquake

***Scenario 3** – A severe earthquake causes failures of the slopes at the north end of the site, exposing up to 75 feet of the north ends of the trenches.*

The NYSERDA team broke the response to this scenario into three phases as described below:

Phase 1 – Initial Detection of a Release – NYSERDA staff would be onsite as soon as possible to investigate the impacts from an earthquake that is capable of cleaving off 75 feet of the north trenches. Onsite security staff already performs hourly drive-arounds on the site and could discover the SDA problem almost immediately. The “best” estimated time for this phase is 2 hours.

Phase 2 – Containment Barrier Installation – Due to the probable instability of the North slope, it would be prudent to establish initial containment of the release by erecting a wall at the base of the slope. The wall could be keyed into the Unweathered Lavery Till to contain migration of the leachate contamination. It is uncertain how much leachate would result from a breach this large, but we assume what is initially released as a result of the earthquake has migrated downstream (Erdman Brook) within a few days of the release. This containment wall is to capture any contamination that could be caused by aftershocks/tremors and/or adverse weather conditions. Pump and treatment of water collected on the upgradient side of the wall is also envisioned. The “best” estimate for constructing this containment wall is 3 days after detection of the release.

Phase 3 – Stabilize the Trench Ends – Once the barrier wall at the base of the North slope is established, it will be necessary to work (from the bottom) to provide slope stability up to the point of the exposed trenches. A trench containment structure could be constructed to effectively seal the exposed ends of the trenches. Pilings driven with grout and cover or Concrete SurePack barriers could be used. Helicopter delivery of materials would be possible. Stabilizing the trench ends is “best” estimated at 5 days after the construction of the containment barrier.

Phase	Lower Bound Time	"Best" Estimate Time	Upper Bound Time
1 – Initial Detection of Release	1 hour	2 hours	1 day
2 – Containment Barrier Installation	2 days	3 days	5 days
3 – Stabilize the Trench Ends	2 days	5 days	8 days
Total Time for Scenario to be Completed	4 days, 1 hour	8 days, 2 hours	14 days

7.1.4 Scenario 4 – Slope Erosion

***Scenario 4** – Severe rains cause rapid erosion of the slopes at the north end of the site, exposing several feet of the north ends of the trenches.*

The NYSERDA team assumed a 24-hour storm event for this scenario. This scenario would involve a response similar to Scenario 3, but would require more time to allow Erdman Brook to return to normal levels. The NYSERDA team broke the response to this scenario into four phases as described below:

Phase 1 – Initial Detection of a Release – NYSERDA staff are required to investigate potential impacts to the SDA whenever there is a heavy rainfall event. It is unlikely that our onsite security staff would notice anything while performing its hourly drive-around on the site. The “best” estimated time for this phase is 1 day.

Phase 2 – Waiting for Erdman Brook to Return to Normal Levels – The watershed for Erdman Brook is quite small and, as such, would return to normal levels quickly. The “best” estimate for this is 12 hours.

Phase 3 - Containment Barrier Installation – Due to the probable instability of the North slope, it would be prudent to establish initial control of the release by erecting a wall at the base of the slope. The wall could be keyed into the Unweathered Lavery Till to contain migration of the leachate contamination. It is uncertain how much leachate would result from a breach this small, but we assume what is initially released as a result of the rains has migrated downstream (Erdman Brook) within a few days of the release. This containment wall is to capture any contamination that could be caused by aftershocks / tremors and/or bad weather conditions. Pump and treat of water collected on the upgradient side of the wall is also envisioned. It is also assumed that the geomembrane cover would still be in place, as it is anchored well between trenches, and will likely provide rain protection to the trench end. The “best” estimate for constructing this containment wall is 3 days after Erdman Brook has returned to normal levels.

Phase 4 – Stabilize the Trench Ends – Once the barrier wall at the base of the North slope is established, it will be necessary to work (from the bottom) to provide slope stability up to the point of the exposed trenches. A trench containment structure could be constructed to effectively seal the exposed ends of the trenches. Pilings driven with grout and cover or Concrete SurePack barriers could be used. Helicopter delivery of materials would be possible.

Stabilizing the trench ends is “best” estimated at 5 days after the construction of the containment barrier.

Phase	Lower Bound Time	"Best" Estimate Time	Upper Bound Time
1 – Initial Detection of Release	1 hour	1 day	3 days
2 – Wait for Erdman Brook to Return to Normal Levels	1 hour	12 hours	1 day, 12 hours
3 – Containment Barrier Installation	2 days	3 days	5 days
4 – Stabilize the Trench Ends	2 days	5 days	8 days
Total Time for Scenario to be Completed	4 days, 2 hours	9 days, 12 hours	17 days, 12 hours

7.1.5 Scenario 5 – Trench Overflow

***Scenario 5** – Severe rains cause the trenches to fill with water up to the weathered till layer, material flows out of trenches in the subsurface layer (or possibly at the surface), and reaches the slopes at the north or east side of the site.*

The NYSERDA team broke the response to this scenario into five phases as described below:

Phase 1 – Detect Leachate Level Increase – NYSERDA’s environmental monitoring contractor measures leachate levels at the SDA quarterly. This would be the first indication of a possible release. The “best” estimated time for observing an increase in the trench leachate levels is 45 days.

Phase 2 – Sample Groundwater and Surface Water/Identify the Seep – NYSERDA, in consultation with the regulatory agencies, would likely initiate sampling of groundwater and surface water to determine if there is migration of trench leachate, as well as begin daily walkover inspections of the SDA and surrounding area to identify the seep. The “best” estimate for identifying the seep is 12 weeks.

Phase 3 – Initial Detection of a Release – Once the seep has been found, confirmatory sampling and analysis would take place. The “best” estimate for detecting a release from the confirmatory sampling and analysis is 7 days.

Phase 4 – Pump Trench(es) – NYSERDA, in consultation with its engineering contractor, would develop a plan to pump trench(es) to lower the levels below the interface between the weathered and Unweathered Lavery Till. Pumping operations would likely include using holding tanks from an outside vendor, as there is limited capacity in the two empty Frac Tanks at the SDA. To pump the trench(es) down is “best” estimated at 26 weeks from the time of detection at the seep.

Phase 5 – Sample Seep – Confirmatory sampling would continue at the seep to monitor when the released material is no longer propagating into nearby streams. The “best” estimate for this phase is 12 weeks.

Phase	Lower Bound Time	"Best" Estimate Time	Upper Bound Time
1 – Detect Leachate Level Increase	1 day	45 days	84 days
2 – Sampling Groundwater and Surface Water / Identify Seep	2 days	84 days	182 days
3 – Initial Detection of a Release	1 day	7 days	30 days
4 – Pump Trench(es)	14 days	182 days	365 days
5 – Sample the Seep	14 days	84 days	365 days
Total Time for Scenario to be Completed	32 days	402 days	1,026 days

7.1.6 Scenario 6 – Groundwater Outflow

Scenario 6 – *During routine sampling activities, water or sediment samples from an adjacent stream indicate elevated levels of radiological contamination. The source of this contamination is an unspecified groundwater seep from the SDA slopes.*

The NYSERDA team broke the response to this scenario into four phases as described below.

Phase 1 – Routine Sampling and Analysis – NYSERDA’s environmental monitoring contractor samples surface water adjacent to the SDA quarterly. Samples are collected and sent to a laboratory for analysis. The external surfaces of the samples are screened before leaving the WVDP site. If typical leachate contaminants are present and at levels high enough to be detected with field instruments, the contamination would be discovered before it left the site. However, lower level contamination (e.g., not readily detected with field instrumentation), would not be known until the laboratory completes their testing. Our contractor would notify NYSERDA verbally as soon as the laboratory reported elevated levels in a sample. The laboratory would make notification by phone when the results were obtained; a written report would not be required. Therefore, the “best” estimated time for learning of elevated levels of contamination is 30 days.

Phase 2 – Locating the Seep – NYSERDA would immediately conduct a walkover inspection of the SDA and surrounding area upstream of the contaminated surface water to locate the seep. It is expected a seep large enough to cause elevated levels in the stream would likely be discovered during a single inspection. The “best” estimate for locating the seep is 3 days, which allows for local testing for confirmatory sampling and analysis.

Phase 3 – Initial Action – Once the seep has been found, NYSERDA, in consultation with its engineering and maintenance contractors, would develop a plan to intercept the seep, isolate it

from the environment, and collect the contaminated water in a tank (similar to spring development for water supply). Contaminated water could then be pumped to another tank for holding or transportation and treatment. Appropriate double wall tanks are readily available 30 miles away in Buffalo and 90 miles away in Rochester, New York. The “best” estimate for interception of the seep is 3 days.

Phase 4 – Confirmatory Sampling – Confirmatory sampling would continue in the surface water to monitor when the released material is no longer propagating into nearby streams. The “best” estimate for confirmatory sampling is 12 weeks.

Phase	Lower Bound Time	"Best" Estimate Time	Upper Bound Time
1 – Sampling and Analysis	1 day	30 days	45 days
2 – Locating the Seep	1 day	3 days	5 days
3 – Initial Action	2 days	3 days	7 days
4 – Confirmatory Sampling	14 days	84 days	365 days
Total Time for Scenario to be Completed	18 days	120 days	422 days

Additional information for Scenario 6 (added by the QRA team, from Reference 7.1-3):

Figure 7.1-1 shows the locations of the surface water sampling points. Point WNERB53 in Erdman Brook and point WNFRC67 in Frank's Creek monitor potential releases from the SDA. A background sampling point is located in Buttermilk Creek. Water samples are collected quarterly. The samples are analyzed for gross alpha, gross beta, and tritium levels.

Beginning in 2008, stream sediments are sampled once every 5 years. The previous sediment sampling frequency was annually. The sediment sampling points are not shown on Figure 7.1-1. Point SNSP006 is located in Frank's Creek at the West Valley site property fence line. Point SFTCSED is located in Buttermilk Creek at Thomas Corners Road. Sediment samples are analyzed for gross alpha, gross beta, gamma isotopic, uranium isotopes, and strontium-90 (metals analyzed only at SFTCSED).

7.1.7 References

- 7.1-1. Scenarios 1 through 5, e-mail communication, T. H. Attridge, NYSERDA, to J. W. Stetkar, July 17, 2008
- 7.1-2. Scenario 6, e-mail communication, M. R. Weishan, NYSERDA, to J. W. Stetkar, July 31, 2008
- 7.1-3. E-mail communication, M. J. Willett, NYSERDA, to J. W. Stetkar, July 31, 2008

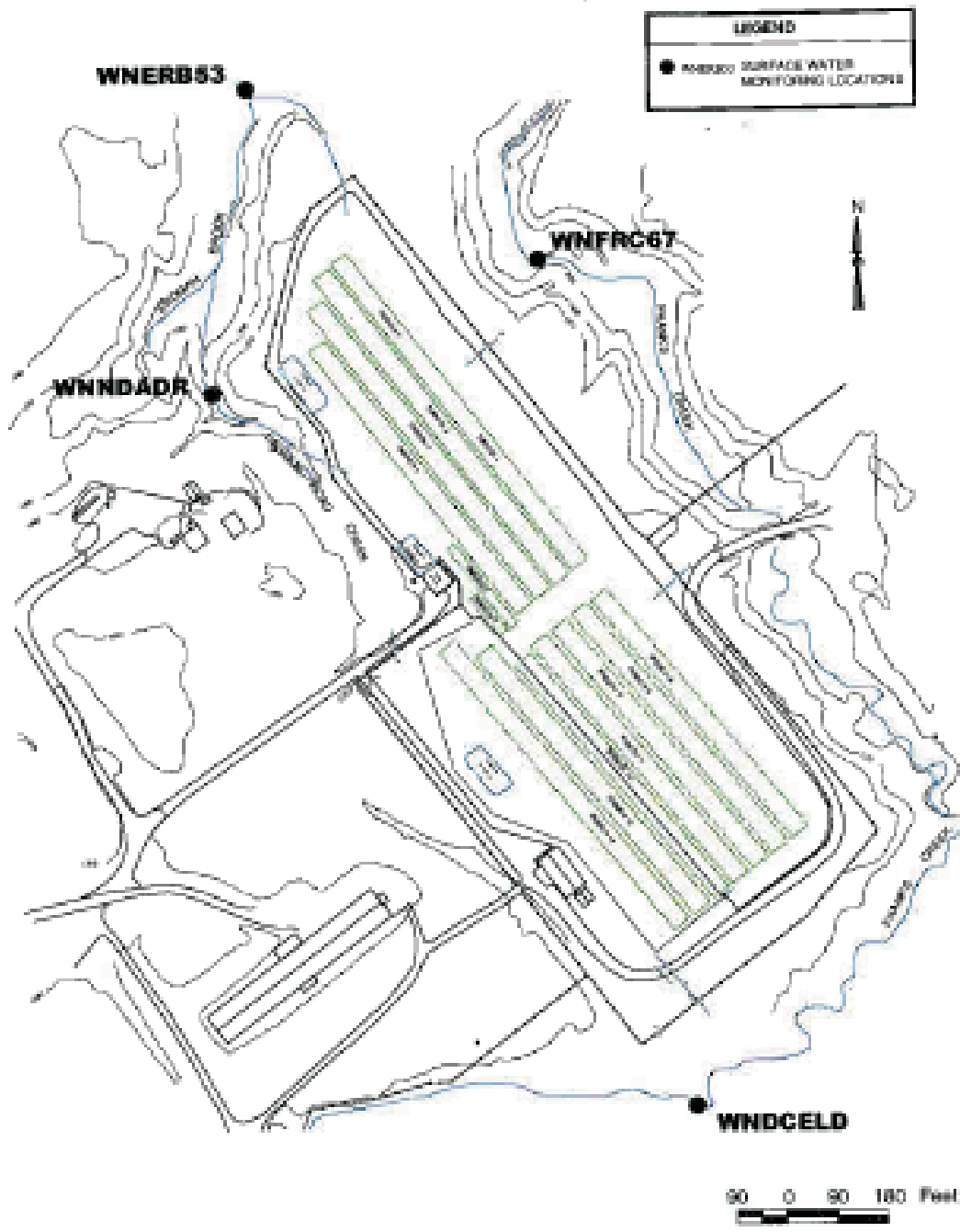

Figure 7.1-1. Surface Water Sampling Points

7.2 GEOMEMBRANE UNAVAILABILITY

The geomembrane covers provide an important barrier against water intrusion into the SDA waste trenches from precipitation and surface water flows, and protect against potential erosion of the trench caps. Damage to only the geomembranes will not directly cause a release of waste materials from the trenches. However, uncovering of the trenches increases their vulnerability to potential impacts from subsequent flooding or water intrusion. This section describes the analyses that were performed to evaluate the unavailability of the geomembranes.

7.2.1 System Description

The following summary information is derived primarily from References 7.2-1 through 7.2-5.

Figure 7.2-1 shows the layout of the SDA trenches. The geomembranes cover almost all of the area inside the site fence, which is denoted by the dark boundary line. The north end of the cover terminates beyond the north ends of Trenches 2 through 5. The south end of the cover terminates between the south ends of Trenches 8 through 14 and the access road. The east side of the cover terminates between the trenches and the fence. In the North Disposal Area, the west side of the cover extends over the two filled lagoons. In the South Disposal Area, the west side of the cover extends over the dashed below-grade slurry wall, including the inactive filled lagoon. The total covered area is approximately 13 acres. Figure 7.2-2 shows an aerial view of the SDA, outlining the covered areas.

The geomembranes were installed in stages, as summarized below.

Geomembrane Installation Timeline		
Trenches	Geomembrane Material	Installation Date
13 – 14	Very Low Density Polyethylene ; 40-mil thickness; installed over 90-mil polypropylene geofabric cushion	1993
1 – 8, 10 – 12	Reinforced Ethylene Interpolymer Alloy (EIA-R XR-5); 30-mil thickness; installed directly on grass surface	1995
9	Reinforced Ethylene Interpolymer Alloy (EIA-R XR-5); 30-mil thickness; installed over 90-mil polypropylene geofabric cushion	1999

The original VLDPE material installed over Trenches 13, 14, and the west side of the South Disposal Area cannot be heat-welded to the XR-5 material that is installed over the remainder of the site. The east edge of the VLDPE cover is anchored along the crest of Trench 12. The west edge of the XR-5 cover extends over the VLDPE cover into the swale between Trench 12 and Trench 13. The west edge of the XR-5 cover is anchored there with sandbags that are encapsulated into a welded flap of the XR-5 material. All of the other XR-5 cover sections are heat-welded together at adjoining seams. Wind anchors of sand or crushed stone, installed in the drainage swales between each trench and around the perimeter, prevent wind uplift of the geomembrane.

Several penetrations exist in the geomembranes. Most penetrations in the areas directly over the trenches contain standpipes for the leachate level measurement probes. Penetrations at the ends of each trench contain the trench identification monuments. Penetrations near the cover peripheries contain standpipes for the drainage detention basins. The penetrations are sealed at the geomembrane surface by heat-welded boots that extend up around the standpipes.

The nominal design lifetime of the VLDPE and XR-5 materials in fully exposed environments is approximately 20 to 25 years. Lifetime is limited primarily by oxidation of the polymer stabilizer under ultraviolet exposure and by tearing due to tensile stresses. The primary failure causes noted in the literature are chemical incompatibility, seam failure, tearing from sharp objects, wrinkling from thermal expansion and contraction, and differential settling of the substrate.

7.2.2 Inspection and Maintenance History

The geomembranes were inspected monthly from August 1993 through December 1996. The inspection frequency was reduced to twice per year from 1997 through 2005. Annual inspections have been performed since 2006.

All inspections are fully documented and are retained in the NYSERDA project files. Any noted deficiencies are recorded in the inspection report (Reference 7.2-6). Geomembrane repairs are performed by contract personnel at the direction of the NYSERDA project engineer.

All inspection reports were reviewed for this study. The following items were noted from the inspection and repair histories.

- Except for the event discussed in Section 7.2.4.4, no other significant failures (e.g., large material tears, uplift or failure of wind anchors, etc.) and no unexpected physical or chemical degradation of the geomembranes have been observed.
- Standpipes in the drainage detention basins at the east side of Trenches 1 and 2 and at the northeast corner of Trench 2 were damaged by snow and ice sliding off the geomembrane covers. Ice dams were installed to protect these standpipes, and no further damage has occurred.
- Inspections typically identify a number of small tears and puncture holes in the geomembranes. The defects occur most frequently at the penetration boots and in welded seams. The noted opening sizes are typically less than 1 inch to about 6 inches long, with the most common fault being a tear or slit. The number of noted defects does not seem to be increasing, despite the longer current inspection intervals.
- The inspections are typically quite detailed, often noting very small defects. There is some evidence of repeat failures, particularly at welded patches and at stress points around penetration boots.
- Repairs are typically completed within 1 month after the inspection. The inspection report contains an entry to confirm that all defects noted during the previous inspection have been repaired.

- Tests performed in 2008 indicated that the VLDPE stabilizer is no longer protecting the VDLPE from oxidation and that the VDLPE may be nearing the end of its useful lifetime. As stated elsewhere in this report, the VLDPE geomembrane will be replaced in 2010.
- Tests performed in 2008 indicated some evidence of oxidation of the XR-5 stabilizer. The tests concluded that no unexpected aging or degradation has occurred and that the XR-5 geomembrane has many years of remaining service life.

The QRA team performed a site walkdown on June 24, 2008. During that walkdown, small tears were noted at the boot for the Trench 5 north monument penetration. The previous NYSERDA inspection was performed on May 23, 2008. The observed items were noted on the inspection report, but had not yet been repaired.

Based on the 2008 measured oxidation rate, NYSERDA currently plans to replace the VLDPE geomembrane over Trenches 13 and 14 in 2010. The 2008 tests indicated that the XR-5 material is oxidizing more slowly, and it has a slightly longer nominal design life. NYSERDA currently believes that the XR-5 geomembranes will need replacement in approximately 2015, or perhaps somewhat later (Reference 7.2-7).

7.2.3 Contributors to Unavailability

This analysis assumes that routine inspections and maintenance of the geomembranes will continue for the 30-year period of the SDA risk assessment. The NYSERDA engineers have also indicated that focused inspections are performed after severe storms and other events that may affect the geomembranes or the engineered infiltration control systems. The QRA team's reviews of the NYSERDA inspection reports and maintenance records since 1993 confirm that these programs provide effective detection and timely repairs of minor defects and other conditions that develop during normal site operation. There is no indication of adverse trends in the number or severity of geomembrane anomalies, and no new failure modes have been identified. Therefore, this analysis includes credit for the established inspection, testing, and corrective maintenance programs to effectively manage normal wear and aging of the geomembranes over the next 30 years.

The following conditions contribute to functional unavailability of the geomembrane covers. For this analysis, "functional unavailability" means that a large section of the geomembrane is effectively removed from one or more trenches.

7.2.3.1 High Winds and Tornadoes

The geomembrane wind anchors are designed for a maximum wind uplift force of 9 pounds per square foot, with an additional applied safety factor of 1.25 (Reference 7.2-3). The available design analyses do not document the wind conditions that correspond to this force, and no independent analyses were performed for this study. According to Section 4.2.1 of the WVDP Safety Analysis Report (Reference 7.2-8), the site design-basis straight-line maximum wind speed is 90 mph, with a gust response factor increase to 115 mph. According to Section 4.2.2 of the Safety Analysis Report, the design-basis tornado maximum wind speed is 160 mph, with a rotational speed of 110 mph. Based on this information, it is assumed that the geomembranes will be damaged by each of the following conditions.

- Straight-line winds with gust speeds that exceed 115 mph
- Tornadoes of Fujii intensity F2 (wind speed 113 – 157 mph), or higher

Section 7.2.4.4 summarizes a geomembrane wind damage event that occurred in March 2009 and discusses its relevance to these success criteria and the QRA results.

7.2.3.2 Earthquakes

Strong motion earthquakes may cause failures of the slopes along the north end of the SDA adjoining Erdman Brook or along the east side of the SDA adjoining Frank's Creek. The analyses in Section 6.2 conclude that slope failure surfaces may intersect the SDA trench area at peak ground accelerations above approximately 0.25 g. Substantial slippage of the adjacent slopes may also disrupt the peripheral anchors and cause stress failures of the geomembranes, even if the slope failure surfaces do not directly intersect the waste trenches. Therefore, it is assumed that the geomembranes will be damaged by the following condition.

- Seismic events with peak ground accelerations of 0.25 g, or higher

7.2.3.3 Aircraft Crashes

Commercial and military aircraft crashes will cause extensive physical damage to the geomembranes, large fires, and significant disruption of the compacted soil caps. General aviation aircraft typically do not have enough mass or energy to fully penetrate the trench caps, but it is assumed that a fuel fire will ignite the geomembranes. Therefore, it is assumed that the geomembranes will be damaged by any aircraft crash.

- Commercial aircraft crash
- Military aircraft crash
- General aviation aircraft crash

7.2.3.4 Meteorite Impacts

The SDA threat screening analyses concluded that moderate- to small-sized meteorites may have impact frequencies that are comparable to the frequencies of other threats that are evaluated in the risk assessment. Therefore, this analysis accounts for geomembrane damage from meteorite impacts.

- Moderate- to small-sized meteorite impacts

7.2.3.5 Fires

Flammability ratings and ignition temperatures were not readily available for the XR-5 geomembrane material that covers most of the SDA (Trenches 1 – 12) or the VLDPE material that covers Trenches 13 and 14. It is understood that these materials have some degree of fire resistance and that XR-5 is often used to line secondary confinement basins for petroleum storage tanks. However, it is also understood that the material will ignite if exposed to an open flame for an indeterminate period of time. It is assumed that the geomembranes are susceptible to ignition and damage from each of the following conditions.

- Wildfires (forest fire, grass fire, etc.)
- Gas pipeline fires

7.2.3.6 Slope Gully Erosion

Intense precipitation may cause significant erosion and migration of gullies in the slopes along the north end of the SDA adjoining Erdman Brook or along the east side of the SDA adjoining Frank's Creek. The analyses in Section 6.4 conclude that gully headcuts may begin to breach the SDA fenced area during severe storms. This intrusive damage and potential slippage of the adjacent slopes may disable the stormwater drainage systems, disrupt the peripheral anchors, or cause stress failures of the geomembranes. Therefore, it is assumed that the geomembranes will be damaged by the following condition.

- Rapid slope gully erosion that extends within the SDA fenced area

7.2.3.7 Planned Replacement

According to the measured geomembrane stabilizer oxidation rates, it is currently anticipated that the VLDPE material will be replaced in 2010, and the XR-5 material will be replaced in approximately 2015 (Reference 7.2-7). These dates fall within the 30-year time period for the SDA risk assessment. Detailed plans and procedures for the replacement projects have not yet been developed. The NYSERDA engineers have indicated that there are several potential benefits if the existing covers are left in place, and the new geomembranes are installed over them. However, removal of the existing covers may be required to ensure that the new geomembranes are properly anchored in the drainage swales between the trenches and at the periphery of the trench area. The NYSERDA engineers could not confirm that the old geomembranes will remain in place or that the trench surfaces will remain fully covered throughout the replacement projects. Therefore, this analysis evaluates each of the following contributions.

- Planned replacement of VLDPE geomembrane
- Planned replacement of XR-5 geomembrane

7.2.4 Quantification of Unavailability

7.2.4.1 Disruptive Events

Table 7.2-1 summarizes the occurrence frequencies for the disruptive events that contribute to geomembrane failures. It also lists the section of this report that documents the derivation of each frequency.

Section 7.1 summarizes the NYSERDA estimates for the amount of time that is required to replace the geomembranes after an unexpected damaging event. Scenario 1 and Scenario 2 from those assessments apply to the types of damage conditions that are evaluated in this analysis. Scenario 1 applies after an aircraft crash, and Scenario 2 applies after tornado damage. The NYSERDA team estimated that essentially the same total mitigation times apply for both scenarios, determined primarily by the amount of time that is required to manufacture and install the new geomembranes. Therefore, those times are used for all disruptive events in this analysis.

The NYSERDA "best" estimate is assigned a weight of 80% that it is the "true" mitigation time for this analysis. The "lower bound" and "upper bound" estimates are each assigned weights of 10%. This process applies relatively high confidence to the NYSERDA team's "best" estimate. General references regarding the use of expert opinion often recommend assignments of lower confidence, for example a weight of 60%. However, the estimates for this study were derived from focused discussions among the NYSERDA project team, and their bases are well documented. Many of the team members have worked at West Valley for several years and were directly involved with the current geomembrane installation projects. That experience justifies generally higher confidence in the team's "best" estimates. The following time distribution is used for reinstallation of the geomembranes after any of the disruptive damage conditions in Table 7.2-1.

Geomembrane Replacement Times after Disruptive Events					
Weight = 0.10		Weight = 0.80		Weight = 0.10	
Days	Year	Days	Year	Days	Year
196	0.537	252	0.690	356	0.975

The threat frequency distributions in Table 7.2-1 are multiplied by these weighted replacement times to quantify the unavailability contribution from each disruptive event. These results are summarized in Table 7.2-2.

7.2.4.2 Planned Replacement

According to current expectations, two geomembrane replacement projects will be implemented during the 30-year time frame of the risk assessment. A new membrane will be installed over Trenches 13 and 14 (the VLDPE-covered area) in 2010, and a new membrane will be installed over the remainder of the SDA in approximately 2015. The NYSERDA team estimated that there is approximately 75% to 80% probability that the new geomembranes will be installed directly over the current membranes and that the trenches will remain fully covered during each replacement project. The engineers also expect that the entire XR-5 geomembrane will be replaced at the same time, but perhaps in sections to facilitate the installation process (Reference 7.2-9).

The NYSERDA team's evaluations of Scenario 1 and Scenario 2 in Section 7.1 indicate that their "best" estimate for the amount of time required to install the new geomembranes is approximately 16 weeks (112 days) after the materials are received onsite. This estimate should also apply for the amount of time that is required to install the new membranes during the planned replacement projects. The 16-week estimate applies for installation of the entire geomembrane over all trenches. It is expected that less time will be required to install the new membrane section over only Trenches 13 and 14 in 2010. It is also possible that somewhat less time will be required to install the new membrane over the remainder of the trenches in 2015.

The following assumptions are used for this analysis.

- Each project is assigned 75% probability that the new membrane will be installed directly over the existing cover, and 25% probability that the old cover will be substantially removed before the new membrane is installed.
- If the old membrane is removed, it is conservatively assumed that large sections of the trenches will remain uncovered for the full duration of the project, until the new installation is completed.
- The "best" estimate new membrane installation time for the XR-5-covered area is 16 weeks (112 days). The "lower bound" estimate is 91 days, and the "upper bound" estimate is 150 days (e.g., one-half of the Phase 2 estimates for Scenario 2 in Section 7.1.2). This project will re-cover more than 75% of the entire SDA, and it will require sealed connections with the section installed in 2010.
- The estimated new membrane installation times for the VLDPE-covered area are one-half the times for the XR-5-covered area. This project will re-cover less than 25% of the entire SDA. However, extra time may be required to install new anchors and seal the connections between Trench 12 and Trench 13.

The following table summarizes the estimated installation time distributions for the planned replacement projects.

Estimated Times for Planned Geomembrane Replacement Projects						
Geomembrane Replacement Area	Weight = 0.10		Weight = 0.80		Weight = 0.10	
	Days	Year	Days	Year	Days	Year
VLDPE	46	0.126	56	0.153	75	0.205
XR-5	91	0.249	112	0.307	150	0.411

The unavailability contributions from these projects are based on the fact that each replacement will occur once during the 30-year time period of this study, there is 25% probability that the trenches will be uncovered during each project, and the installation times are represented by the distributions shown above. These results are summarized in Table 7.2-2.

7.2.4.3 Summary of Results

Table 7.2-2 summarizes the results from these analyses. The mean unavailability of the geomembranes is 1.95E-02. This means that a large fraction of the trench surfaces may be uncovered for approximately 2% of the time during the 30-year period of the SDA risk assessment (i.e., about 214 days in 30 years). There is 90% confidence that the unavailability will be in the range between 6.82E-03 and 4.58E-02 (i.e., between 75 days and 502 days in 30 years).

The most important contributor to the overall unavailability is damage from rapid erosion of gullies in the adjoining slopes, which accounts for almost 60% of the total. There is large

uncertainty in that contribution, due to uncertainties about the frequency of severe storms that may cause rapid erosion and uncertainties in the gully erosion models. The next contributor is damage from wildfires, which accounts for approximately 16% of the total. There is also large uncertainty in that contribution, due to the lack of documented data for the frequency and sizes of wildfires in the area surrounding the West Valley site. Planned replacement of the geomembrane over the XR-5-covered area of the SDA accounts for approximately 13% of the total unavailability. Replacement of the geomembrane over the VLDPE-covered area accounts for approximately 7% of the unavailability. Damage from gas pipeline fires accounts for approximately 3% of the total, and all other contributors are much less significant.

7.2.4.4 Geomembrane Wind Damage Event

On March 11, 2009, a portion of the XR-5 geomembrane cover was damaged by strong winds (References 7.2-10 and 7.2-11). The damage occurred during gusting wind conditions, with a maximum recorded wind speed of 31.2 miles per hour (mph) at the site meteorological tower. Peak wind gusts of 55 mph were recorded during the same period at the Buffalo International Airport reporting station. The damage was initiated by wind flow through gaps between and beneath the concrete Jersey barriers that anchor the west side of the geomembrane, near the southeast corner of the NDA and the former NDA hardstand (see Figure 7.2-1). Air blowing under the membrane caused the membrane surface to rise and billow, with correspondingly increased stresses. The extent of the uplift was exacerbated by the lack of anchorage ballast at the base of the Jersey barriers, contrary to original design and installation specifications. The uplift forces eventually caused the affected section of the XR-5 membrane to pull out from the anchorage area between the VLDPE and XR-5 membranes, located in the swale between Trenches 12 and 13. The XR-5 membrane was also torn along a welded seam, located between Trench 7 and the north ends of Trenches 13 and 14 (see Figures 7.2-1 and 7.2-2).

The following items briefly summarize the timeline of the membrane damage and the subsequent NYSERDA response and mitigation actions.

- 9:30 am - Start of initial damage; no damage noted during routine inspection at 9:00 am
- 11:20 am Geomembrane tear reported by local personnel
- 12:00 pm Arrival of West Valley Site Maintenance Program staff at the SDA; first attempts to anchor membrane with bags of concrete (unsuccessful)
- 12:30 pm Arrival of additional personnel with sandbags
- 1:00 pm Damaged section of membrane temporarily anchored with sandbags
- 1:45 pm Arrival of NYSERDA maintenance subcontractor with 100 additional sandbags
- 3:05 pm Damaged sections of membrane repositioned to cover most of exposed surface; gaps remain between damaged and undamaged sections
- 3:30 pm Impermeable material placed over exposed gaps and anchored with sandbags; all exposed surface areas fully covered
- 3:30 pm - Additional sandbags installed and positioned to improve anchorage

4:30 pm

4:45 pm Site secured

Permanent repairs were completed in June 2009, after ambient temperatures were warm enough to facilitate welding of the XR-5 membranes, and qualified replacement material was procured.

This event provides several valuable insights for the QRA analyses.

The damage was initiated by straight-line winds with gust speeds in the range of approximately 32 mph to 55 mph. These wind speeds are considerably lower than the 115 mph gust speed that is discussed in Section 7.2.3.1 and which forms the basis for the wind gust exceedance frequency that is quantified in Table 7.2-1. Figure 5.3-3 shows that the mean frequency of wind gusts in the 40 mph to 50 mph range is more than one event per year. This comparison indicates that the 115 mph criterion and its corresponding exceedance frequency may provide optimistic estimates for the frequency of any degree of wind-induced geomembrane damage, without regard to the extent of the resulting damage.

The geomembrane damage was exacerbated by an original installation error. Failure to properly anchor the membrane at the base of the Jersey barriers allowed the initial billowing of a large section of the membrane. This effect would not have occurred if the ballast anchors had been installed. The QRA analyses have not explicitly accounted for these types of installation errors, due to the historical SDA operating experience without any observed significant geomembrane damage.

The damaged section of geomembrane covered approximately 2,500 square feet of the total SDA covered area of approximately 13 acres (approximately 566,280 square feet). Thus, the March 2009 damage corresponds to slightly less than 0.5% (one-half of one percent) of the total geomembrane surface area. The QRA analyses evaluate the frequency of disruptive events that may damage very large sections of the geomembranes, such that a large fraction of the SDA surface area is exposed to incident precipitation. The analyses do not explicitly quantify what is "large". However, it is conservatively assumed that the damage leaves the entire SDA surface exposed. Thus, although the March 2009 event caused much more significant damage than had ever before occurred, the extent of that damage was minimal in the context of the QRA analyses.

The event demonstrates the effectiveness of NYSERDA response and mitigation actions. The exposed surface was completely recovered within less than 4-1/2 hours after the damage was discovered, or within a maximum of 6 hours after the damage started. The provisional repairs were made with impermeable material that is an effective barrier to water intrusion. The QRA analyses do not include credit for these types of provisional repairs, conservatively assuming that the entire exposed area must be recovered with fully qualified geomembrane material.

The QRA analysis results in Table 7.2-2 quantify a mean unavailability of the (entire) geomembrane due to wind-caused damage of approximately $8.8E-07$, or 6 hours in approximately 780 years. The 95th percentile of the uncertainty distribution is approximately $3.0E-06$, or 6 hours in approximately 225 years. The March 2009 event corresponds to an unavailability of a very small fraction of the geomembrane cover for less than 6 hours in 13 years of the XR-5 membrane installation, or approximately $5.3E-05$. The overall results shown

in Table 7.2-2 confirm that the March 2009 event would account for a very small fraction of the total geomembrane unavailability that is quantified in the QRA, even if that damage had been much more extensive and the NYSERDA mitigation times had been substantially extended.

In summary, the March 2009 geomembrane damage event clearly shows that the QRA analyses are not valid for estimating the frequency of wind-induced damage to relatively small sections of the SDA geomembranes. The event also confirms that the QRA models and assumptions regarding NYSERDA response and mitigation are quite conservative, because they do not account for interim provisional repairs. Exposure of sufficient SDA surface area to significantly increase the waste trench vulnerability to water intrusion requires much more extensive damage than occurred during this event. Thus, although the event revealed an installation error and an important vulnerability that had not been anticipated (which has now been corrected), the actual extent of the damage and its potential consequences were minimal in the context of the QRA analyses.

7.2.5 References

- 7.2-1. "Infiltration Controls System Description and Reference Manual, State-Licensed Disposal Area (SDA)", Draft, NYSERDA, June 2008
- 7.2-2. "Schematic Design Report, Infiltration Control, State Licensed Disposal Area, Western New York Nuclear Service Center, West Valley, New York", Dames & Moore, April 1992
- 7.2-3. "Design Report, Installation of Additional Geomembrane Covers, State Licensed Disposal Area, Western New York Nuclear Service Center, West Valley, New York", Dames & Moore, May 1995
- 7.2-4. "Draft Environmental Impact Statement for Decommissioning and/or Long-Term Stewardship at the West Valley Demonstration Project and Western New York Nuclear Service Center", DOE/EIS-0226-R, United States Department of Energy and New York State Energy Research and Development Authority, draft for internal review, 2008
- 7.2-5. "Screening Analysis of Remedial Technologies Potentially Applicable to the U.S. Nuclear Regulatory Commission-Licensed Disposal Area and the New York State-Licensed Disposal Area at the Western New York Nuclear Service Center", WSMS-WV-05-0006, Revision 0, Washington Safety Management Solutions, September 2005
- 7.2-6. "Geomembrane Cover System Inspection", West Valley Site Management Program, Operations and Engineering Procedure OPS007.00, Revision 0, July 2006
- 7.2-7. E-mail communication, P. J. Bembia, NYSERDA, to J. W. Stetkar, April 29, 2009
- 7.2-8. "West Valley Demonstration Project, Safety Analysis Report for Waste Processing and Support Activities", WVNS-SAR-001, Revision 11, West Valley Nuclear Services Company, June 2007
- 7.2-9. E-mail communication, M. R. Weishan, NYSERDA, to J. W. Stetkar, July 31, 2008

7.2-10. "Response Report on the March 11, 2009 Geomembrane Cover Wind Damage at the State-Licensed Disposal Area (SDA)", New York State Energy Research and Development Authority, April 24, 2009

7.2-11. E-mail communication, T. H. Attridge, NYSERDA, to J. W. Stetkar, August 3, 2009

Geomembrane Threat	Frequency (event / year)				Report Section
	5th Percentile	Median	Mean	95th Percentile	
Wind gusts \geq 115 mph	5.64E-09	1.58E-07	1.23E-06	4.42E-06	5.3
F2 tornado impact	5.72E-07	3.74E-06	3.26E-05	1.43E-04	5.4
F3 tornado impact	4.15E-07	1.12E-05	4.39E-05	1.93E-04	5.4
F4 tornado impact	1.19E-05	4.94E-05	6.45E-05	1.54E-04	5.4
F5 tornado impact	1.29E-06	1.23E-05	2.06E-05	6.60E-05	5.4
Seismic acceleration \geq 0.25 g	7.54E-06	4.30E-05	7.53E-05	2.45E-04	5.5
Commercial aircraft crash	3.16E-08	8.54E-08	1.06E-07	2.46E-07	5.6
Military aircraft crash	2.18E-08	6.65E-08	8.69E-08	2.17E-07	5.6
General aviation aircraft crash	4.89E-07	7.98E-06	3.36E-05	1.26E-04	5.6
Meteorite impact (\leq 0.3-meter diameter)	5.01E-09	3.59E-08	1.77E-07	7.98E-07	5.7
Wildfire	2.46E-04	2.61E-03	4.66E-03	7.84E-03	5.8
Gas pipeline fire	3.33E-05	3.33E-04	8.87E-04	3.33E-03	5.8
Slope gully erosion	2.21E-03	8.25E-03	1.64E-02	5.22E-02	6.4

Table 7.2-2. Geomembrane Unavailability Results					
Contributor	Unavailability				Fractional Importance
	5th Percentile	Median	Mean	95th Percentile	
Wind gusts \geq 115 mph	3.98E-08	1.10E-07	8.76E-07	3.03E-06	< 0.001
F2 tornado impact	8.66E-08	2.59E-06	2.31E-05	7.80E-05	0.001
F3 tornado impact	5.21E-07	7.77E-06	3.10E-05	1.17E-04	0.002
F4 tornado impact	1.03E-05	3.43E-05	4.53E-05	1.15E-04	0.002
F5 tornado impact	1.60E-06	8.64E-06	1.45E-05	4.53E-05	0.001
Seismic acceleration \geq 0.25 g	5.25E-06	3.02E-05	5.29E-05	1.69E-04	0.003
Commercial aircraft crash	2.15E-08	5.98E-08	7.44E-08	1.74E-07	< 0.001
Military aircraft crash	1.48E-08	4.66E-08	6.11E-08	1.53E-07	< 0.001
General aviation aircraft crash	3.39E-07	5.62E-06	2.35E-05	8.73E-05	0.001
Meteorite impact (\leq 0.3-meter diameter)	3.39E-09	2.52E-08	1.24E-07	5.55E-07	< 0.001
Wildfire	1.73E-04	1.80E-03	3.17E-03	5.57E-03	0.163
Gas pipeline fire	2.47E-05	2.33E-04	6.35E-04	2.34E-03	0.033
Slope gully erosion	1.51E-03	5.80E-03	1.15E-02	3.69E-02	0.593
VLDPE planned replacement	1.12E-03	1.31E-03	1.30E-03	1.44E-03	0.067
XR-5 planned replacement	2.22E-03	2.62E-03	2.60E-03	2.91E-03	0.134
Total	6.82E-03	1.31E-02	1.95E-02	4.58E-02	

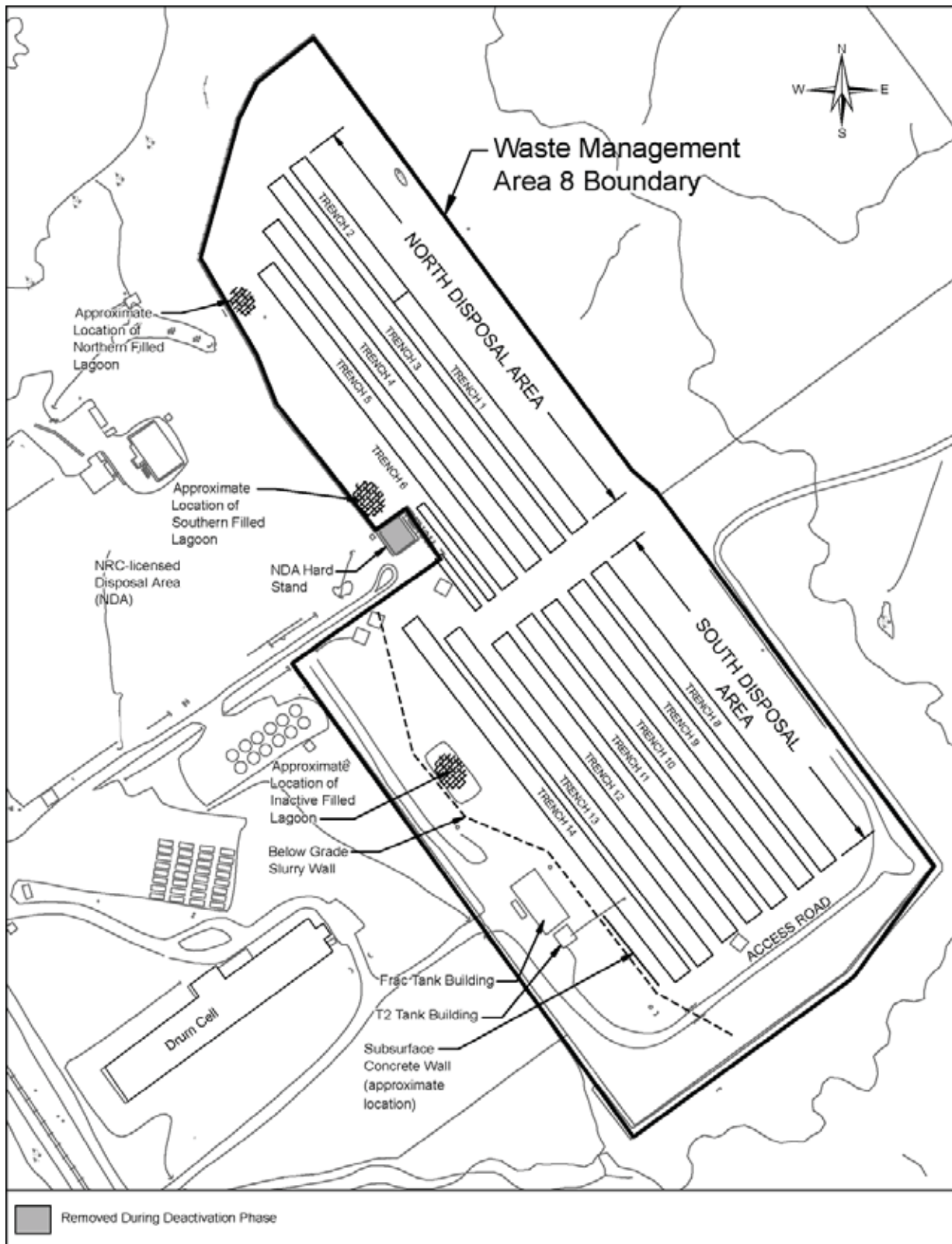

Figure 7.2-1. SDA Trenches (from Reference 7.2-4)

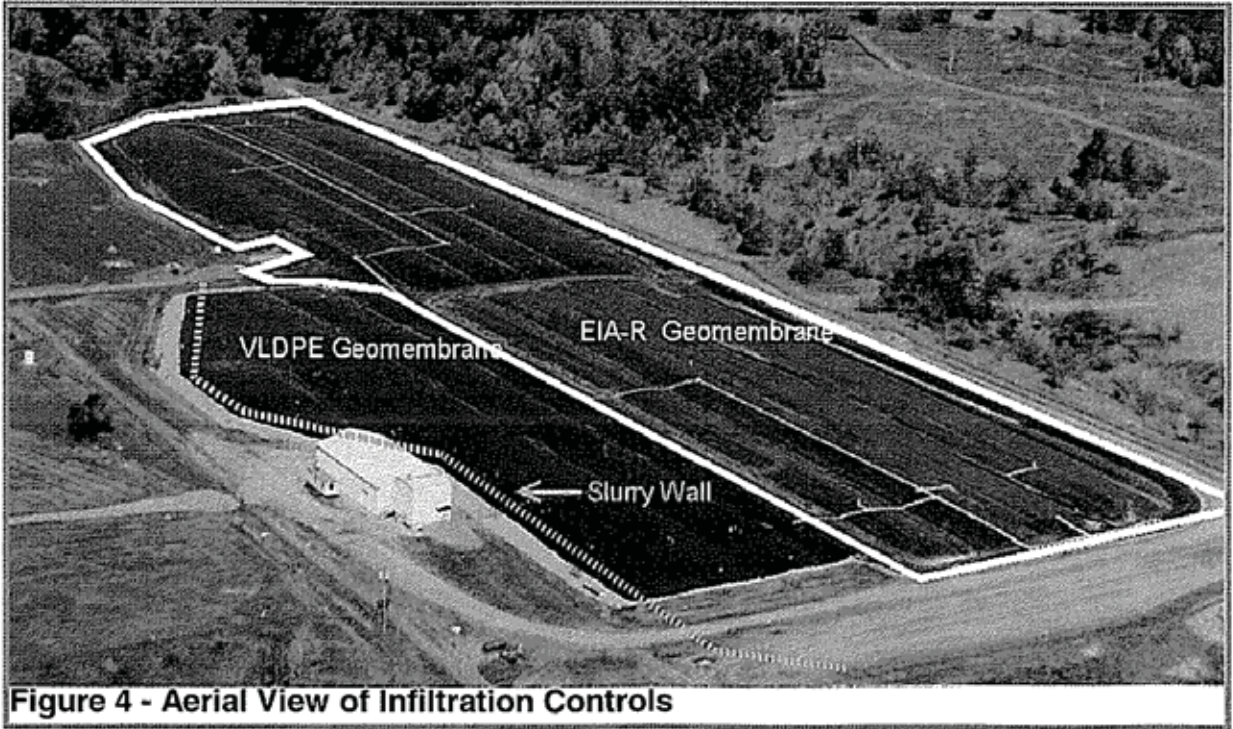

Figure 7.2-2. Geomembrane Covers (from Reference 7.2-1)

7.3 TRENCH CAP EROSION

If the geomembranes are functionally disabled, the compacted clay caps provide an effective second barrier against water intrusion into the SDA waste trenches. The risk assessment includes credit for the caps to prevent or significantly delay water intrusion during precipitation events that occur when the geomembranes are not intact. This section describes the analyses that were performed to evaluate the frequency of events that functionally disable the caps due to extensive erosion.

7.3.1 Trench Cap Erosion Fragilities

Section 6.4.2 documents separate fragility analyses for cap erosion from flows that are parallel and perpendicular to the trench axis. Erosion will occur from both directions during an actual storm event. Therefore, the fragility results from Table 6.4.2 and Table 6.4.3 were added to derive composite fragilities for erosive damage from either cause. Table 7.3-1 shows those results.

Erosion through perpendicular rills is the predominant cause for failure at lower precipitation rates. Parallel erosion begins to contribute when precipitation rates exceed approximately 7 inches in 24 hours for the "high" estimates of soil erodibility conditions. No damaging erosion occurs until precipitation rates exceed 19 inches in 24 hours for the "best estimate" conditions. Parallel erosion is the predominant contributor at high precipitation rates for the "high" erodibility conditions. Parallel and perpendicular erosion contribute about equally at high precipitation rates for the "best estimate" conditions.

7.3.2 Precipitation Events

The analyses in Section 6.4.2 were performed for 24-hour precipitation events. Five nominal storm durations (2, 4, 6, 8, and 10 hours) were used to derive rainfall intensities during these events. Section 5.2 summarizes the historical precipitation data for the region surrounding the West Valley site. Precipitation exceedance frequencies are derived for 24-hour, 48-hour, 3-day, 7-day, and 14-day exposure periods.

The historical experience shows that the largest multi-day cumulative precipitation totals almost always involve severe single-day storms. In other words, the largest 3-day, 7-day, and 14-day cumulative precipitation periods typically include a severe 1-day storm, preceded or followed by days with much lower accumulations. Thus, intense precipitation events that may cause extensive cap erosion are determined almost entirely by single-day storms. Periods of moderate to strong precipitation that continue for several consecutive days are not evident in the regional weather records. (Multi-day snowstorms do occur in the region. Although these storms may result in significant snow accumulations, they do not contribute directly to rapid erosion.)

Reviews of the historical data and examinations of the precipitation exceedance frequencies indicate that 48-hour storm periods may also contribute to significant erosion. The precipitation totals for some 48-hour periods include significant contributions from consecutive days, indicating that longer duration storms may persist for several hours, or short duration storms may span the daily reporting intervals. To account for these storms, it was assumed that the fragility results in Table 7.3-1 apply to both 24-hour and 48-hour precipitation periods. This

assumption introduces some amount of numerical conservatism, because it is likely that some of the 48-hour precipitation totals result from less intense storms. However, it was not practical to refine the historical data analyses or the exceedance frequencies to more precisely account for individual storms. The data and the exceedance analyses confirm that the largest precipitation totals for 3-day, 7-day, and 14-day exposure periods are determined entirely by 24-hour or 48-hour storms. Therefore, extension of the cap erosion analyses beyond a 48-hour period is not warranted.

7.3.3 Quantification of Failure Frequency

A probabilistic weight of 75% was assigned that the "best estimate" parametric conditions in the fragility analyses may apply to actual conditions at the SDA site during the 30-year period of this study. Equal weights of 12.5% each were assigned that the "high" and "low" estimates may apply.

The 24-hour and 48-hour precipitation exceedance frequencies from Section 5.2 were convolved with the weighted fragility results in Table 7.3-1 to derive the frequency of trench cap erosion damage that is sufficient to expose the top surface of the buried waste material. The following table summarizes the results from that calculation.

Frequency of Damaging Trench Cap Erosion, 24-Hour and 48-Hour Precipitation Events (event / year)				
5th Percentile	Median	Mean	95th Percentile	Error Factor
3.89E-05	5.60E-04	8.65E-04	2.57E-03	8.1

These results are determined by the combined effects from the erosion fragilities, the storm intensities, and the storm frequencies. Low erosion fragilities apply for storms of moderate intensity that occur more frequently. High erosion fragilities apply for rare very severe storms. Approximately 54% of this damage is caused by precipitation totals in the 6-inch to 15-inch range. Approximately 27% is caused by precipitation in the 4-inch to 6-inch range, and approximately 19% is due to precipitation that exceeds 15 inches. Two-day storms account for approximately 70% of the total, and approximately 30% is due to 1-day storms.

Table 7.3-1. Composite Trench Cap Erosion Fragilities			
Rainfall Rate (in)	Conditional Probability		
	"High"	"Best"	"Low"
2	0.0000	0.0000	0.0000
3	0.0000	0.0000	0.0000
4	0.0160	0.0000	0.0000
5	0.0240	0.0000	0.0000
6	0.0320	0.0000	0.0000
7	0.0614	0.0000	0.0000
8	0.2730	0.0000	0.0000
9	0.3338	0.0000	0.0000
10	0.4104	0.0000	0.0000
11	0.4104	0.0000	0.0000
12	0.4319	0.0000	0.0000
13	0.5183	0.0000	0.0000
14	0.5372	0.0000	0.0000
15	0.5847	0.0000	0.0000
16	0.5847	0.0000	0.0000
17	0.5847	0.0000	0.0000
18	0.6036	0.0000	0.0000
19	0.6226	0.0304	0.0000
20	0.6511	0.1258	0.0000
21	0.6795	0.1397	0.0000
22	0.6985	0.1675	0.0000
23	0.7175	0.2692	0.0000
24	0.7719	0.3071	0.0000
25	0.7719	0.3071	0.0000
26	0.7883	0.3071	0.0000
27	0.7883	0.3071	0.0000
28	0.8458	0.3071	0.0000
29	0.8540	0.3071	0.0000
30	0.8622	0.3771	0.0000

SECTION 8

SCENARIO ANALYSIS

This section documents the methods and models that were used to quantify event scenarios that result in radioactive material releases from the waste trenches. These scenarios begin with an initiating disruptive event or an evolving site process, and they end with a release of materials into the external environment. Section 8.1 summarizes the general analysis methodology and describes the five release mechanisms that provide the overall framework for the scenario models. Sections 8.2 through 8.6 describe the analyses of each release mechanism. Section 8.7 summarizes the treatment of interdependencies that affect multiple scenarios.

8.1 SCENARIO FRAMEWORK

The scenario-based methodology in this study provides a comprehensive and systematic assessment of the contributors to risk. The risk model framework accounts for all important physical and functional dependencies that affect scenario progression. The risk quantification process evaluates all relevant supporting information and the associated uncertainties at each stage of the analyses.

8.1.1 Risk Model Framework

Figure 8.1-1 shows the functional framework of the SDA risk assessment models. The following sections describe the major scenario analysis elements.

8.1.1.1 Threat Analysis

A large number of potentially disruptive events and natural processes may initiate or contribute to conditions that result in a release of radioactive materials from the SDA waste trenches. The first step of the scenario development process is a systematic evaluation of these threats to determine which specific events and conditions warrant explicit analysis. This evaluation accounts for both the frequency and the potential consequences from each threat. For example, the threat analyses must systematically consider the potential risk contributions from events with high frequencies and low consequences, events with moderate frequencies and moderate consequences, and events with low frequencies and high consequences. Each disruptive event and natural process that is retained for explicit analysis is fully described in terms of its characteristics, its physical and functional impacts on the SDA, and its occurrence frequency or rate of progression. Each event or process then becomes an initiator for one or more risk scenarios.

8.1.1.2 Scenario Analysis

In the broadest context of the entire risk assessment, the scenario analyses begin with the initiating threat and they end with a consequential dose to a receptor. In other words, the entire process depicted in Figure 8.1-1 can be broadly characterized as the analysis of scenarios that contribute to the SDA risk. In this step of the analysis, that broader context is focused on the "front end" of Figure 8.1-1, to identify and develop specific scenarios that are propagated through the risk models.

This study uses a modeling framework of "release mechanisms" to define and structure the scenarios. Five release mechanisms were defined to account for specific types of natural processes and disruptive events, their physical and functional impacts on the SDA, subsequent radioactive material mobilization, and release pathways. Each release mechanism model evaluates the SDA response to a set of threats. The models account for the specific physical and functional impacts from each threat, the effectiveness of natural and engineered barriers, and potential intervention and mitigation measures to prevent or terminate a release. In practice, these models determine which threats will cause a release of radioactive materials, the specific processes that contribute to the release, and the general characteristics of that release. These conditions define the scenarios that will be evaluated through the remainder of the risk assessment. If a release occurs, the models define its location, the affected trench

volume and contents (both liquid and solid), and the release pathways to the external environment.

Thus, the release mechanism models define a systematic path from the initial threats to specific release scenarios, including the physical and functional conditions that contribute to the release, the general characteristics of the release, the frequency of the release, and the associated uncertainties.

8.1.1.3 Release Category Analysis

In practice, many scenarios that result from the release mechanism models may have similar characteristics in terms of the types and quantities of radioactive materials that are released, and their specific environmental release pathways. The release category analyses examine these scenarios and combine releases that behave similarly through the transport and dose models. For example, several individual scenarios may release very similar quantities and types of materials under similar conditions. Their subsequent analyses are then simplified by defining a single release category that is used to characterize these releases in the transport and dose models, because they behave very similarly. Information about the individual contributing scenarios is not lost in this process. The release category "package" of scenarios is simply treated as a group in the remainder of the models.

The release category analyses pay special attention to scenario-specific conditions that may affect subsequent transport or dispersion of the released materials. These conditions may require separate treatment, and their combination with scenarios that are otherwise similar may not be justified.

8.1.1.4 Transport Analysis

The transport analyses use models of the environment surrounding the West Valley site to evaluate how the released material is dispersed and to determine its concentration at various potential receptor locations. In this study, detailed models were developed for the entire drainage basin surrounding the site, including Erdman Brook, Frank's Creek, Buttermilk Creek, and all ancillary tributaries. These models are used to evaluate dispersion, deposition, and dilution of released solids and liquids as the materials are transported from the SDA release point to receptor locations along the streams, and at the confluence of Buttermilk Creek and Cattaraugus Creek. The transport analysis results and release characterization information are used to determine distributions of specific radionuclide concentrations at each receptor location.

8.1.1.5 Dose Analysis

The dose analyses examine the specific radionuclide concentrations at each receptor location and superimpose models of receptor behavior to evaluate the exposure and the corresponding dose. For example, in this study, the target receptors include a residential farmer at the confluence of Buttermilk Creek and Cattaraugus Creek, and a recreational hiker / hunter who walks along the banks of Buttermilk Creek and portions of Frank's Creek. The dose analyses account for these human behavioral patterns, expected uses of creek water for crop irrigation and livestock watering, potential silt deposition from localized flooding, etc., to evaluate the cumulative doses from the liquid and solid radioactive materials at each location. These analyses, with their corresponding scenario contributors, frequencies, and uncertainties, form the results of the risk assessment process.

8.1.1.6 Cross-Cutting Dependencies

Figure 8.1-1 shows two analysis elements that affect multiple steps of the scenario development process. These elements account for potentially important physical and functional dependencies that may affect the models and analyses of specific scenarios.

For example, the threat analyses may identify precipitation as a disruptive event that is potentially important to risk. The storm intensity and the cumulative amount of precipitation may have different impacts on the SDA and its barriers, depending on the specific release mechanism. If a release occurs as a consequence of a storm with a particular precipitation rate, the transport analyses must consistently account for that storm when the material is distributed through the interconnected stream systems. Thus, the threat analyses, scenario analyses, and transport analyses must identify and carefully trace these interdependencies.

Similar considerations apply for the receptor analyses. For example, this study accounts for potential exposures to a recreational hiker / hunter who walks along Buttermilk Creek and Frank's Creek. Therefore, the transport analyses must account for liquid activity concentrations, solid material dispersion, and deposition throughout these creek basins to support a consistent analysis of doses to that receptor.

8.1.2 Release Mechanisms

Five release mechanisms were defined to account for specific types of natural processes and disruptive events, their physical and functional impacts on the SDA, subsequent radioactive material mobilization, and release pathways.

Release Mechanism 1 – Groundwater Flow through Unweathered Lavery Till

This release mechanism accounts for vertical and lateral groundwater flows through the Unweathered Lavery Till and Kent Recessional Sequence soil layers. These flows occur due to existing natural processes at the SDA site. They result in liquid releases into the adjacent streams or Buttermilk Creek. The analyses of this release mechanism account for the current status of the site, its possible conditions during the next 30 years, and the effects from developing conditions during the 30 years since the wastes were initially buried. Section 8.2 provides more details of the methods and models that were used to evaluate these release scenarios.

Release Mechanism 2 – Groundwater Flow through Weathered Lavery Till

This release mechanism accounts for lateral groundwater flows through the Weathered Lavery Till soil layer near the surface of the SDA. These flows occur due to natural processes at the SDA site, if water levels in the trenches rise above the WLT / ULT interface. They result in liquid releases into Erdman Brook or Frank's Creek. The trench water levels are currently below the WLT / ULT interface. The analyses of this release mechanism account for possible conditions that could cause levels to increase during the next 30 years. Section 8.3 provides more details of the methods and models that were used to evaluate these release scenarios.

Release Mechanism 3 – Trench Liquid Overflow

This release mechanism involves liquid overflows from the tops of the waste trenches due to rapid water intrusion. All scenarios for Release Mechanism 3 are initiated by precipitation or severe storms. Significant water intrusion into the waste trenches can occur only if the geomembrane covers are removed from a large portion of the SDA surface area. The compacted clay caps also provide an effective secondary barrier against water intrusion, if they are intact. These scenarios result in liquid releases into Erdman Brook or Frank's Creek via surface water runoff. Section 8.4 describes the specific threat conditions, event scenarios, and supporting analyses that were used to evaluate these releases.

Release Mechanism 4 – Physical Breach of Trench Walls

This release mechanism involves physical breaches of the waste trenches. The scenarios for Release Mechanism 4 are initiated by disruptive events and natural processes that destabilize the slopes on the North end of the site, adjacent to Erdman Brook, and at the East side of the site, along Frank's Creek. Releases occur if the slope damage extends far enough into the SDA site area to physically breach the trench walls and mobilize the waste materials. These scenarios result in liquid releases into the adjacent streams, and disruption of solid materials that may be dispersed throughout the drainage basin by subsequent precipitation and storms. Section 8.5 describes the specific threat conditions, event scenarios, and supporting analyses that were used to evaluate these releases.

Release Mechanism 5 – Physical Breach of Trench Caps

This release mechanism involves severe physical disruption of the SDA site surface to the extent that waste materials are exposed to the environment. All scenarios for Release Mechanism 5 are initiated by high energy impacts on the SDA. These events cause an immediate release of airborne activity from the trenches. They also cause substantial damage to the geomembrane covers and physically disturb the site surface. Release Mechanism 3 accounts for subsequent releases that may be caused by precipitation that occurs before the site is restored to its normal configuration. Section 8.6 describes the specific threats, event scenarios, and supporting analyses that were used to evaluate these releases.

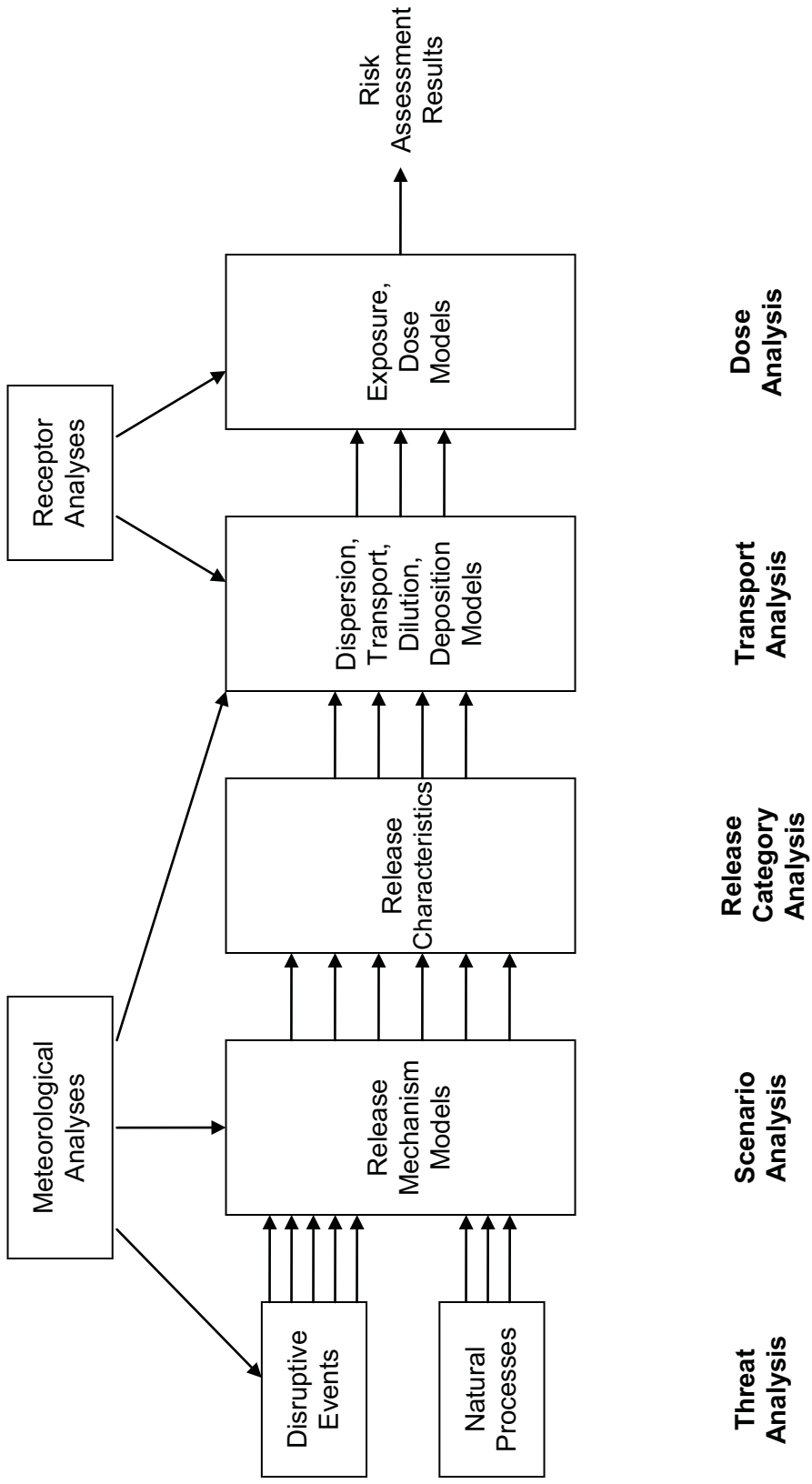

Figure 8.1-1. Functional Framework of SDA Risk Assessment Models

8.2 RELEASE MECHANISM 1

Release Mechanism 1 involves liquid releases from the waste trenches via groundwater flows through the Unweathered Lavery Till and Kent Recessional Sequence soil layers.

8.2.1 Threat Conditions

The scenarios for Release Mechanism 1 involve groundwater flows through the SDA site. These natural processes transport liquids and radioactive leachate from the waste trenches to discharge points along the banks of Erdman Brook, Frank's Creek, and Buttermilk Creek.

Flows through two general pathways contribute to these scenarios.

- (1) Lateral flow through the ULT, with discharges to Frank's Creek or Erdman Brook. Releases into Frank's Creek originate primarily from Trenches 1/2 and 8 at the East side of the site. Releases into Erdman Brook originate from Trenches 1/2, 3, 4, and 5 at the North end of the site. The analyses also account for contributions from lateral flows through the spaces between trenches (e.g., between Trench 3 and Trenches 1/2, and between Trench 9 and Trench 8).
- (2) Vertical flow through the ULT and subsequent lateral flow through the KRS, with discharges to Buttermilk Creek. All trenches at the site contribute to these releases.

8.2.2 Analysis Framework

A detailed logic model is not needed to evaluate possible conditions that may affect the progression of these scenarios, or to support their quantification. The release flow rates and the corresponding radionuclide concentrations are derived from the groundwater flow models described in Section 6.5.

The scenarios are also based on the following information, assumptions, and supporting analyses.

8.2.2.1 Release Scenario Context

Each groundwater release scenario is quantified with a frequency of one event during the 30-year study period. This frequency does not imply that one-thirtieth of the release occurs every year. It means that the type of release that is evaluated by the particular scenario may occur once during the 30-year period of this study.

The analyses in Section 6.5 show that releases into the streams through each of the examined groundwater pathways could occur at some time during the next 30 years if certain combinations of trench water levels and soil conditions actually apply at the SDA site. The amount of the release is very uncertain, as is the time when the contaminated water will first emerge from the nearest slope. However, based on those analyses, the QRA team concluded that each of the potential groundwater releases is possible during the next 30 years, and none of the potential release pathways can be removed from further consideration in the study.

In the context of this risk assessment, each groundwater release scenario is evaluated as a "release event". The assigned frequency of one event in 30 years accounts for the fact that a release may occur during the study period. The groundwater analyses account for the probabilities that each combination of water levels and soil conditions apply at the site. For each set of conditions, the analyses then evaluate the likelihood that a release will occur within the next 30 years if those particular conditions are present. For example, suppose there is probability P1 that condition set S1 applies at the site. If the S1 conditions do not result in a groundwater release within 30 years, then the scenario contains probability P1 that no release will occur. Suppose there is probability P2 that condition set S2 applies. If the S2 conditions will result in a groundwater release within 30 years, then the scenario contains probability P2 that a release with the corresponding characteristics will occur. Those characteristics include the released liquid flow rate, radionuclide concentrations, and associated uncertainties. The scenario models are based on the following important considerations.

- The release starts at some unknown time during the next 30 years.
- The release continues until it is discovered by NYSERDA during their routine monitoring and sampling activities.
- When NYSERDA discovers the release, they will take all necessary actions to mitigate the release itself, or its consequences. These intervention and mitigation actions effectively end the release scenario for the purposes of the risk assessment.

In summary, each release scenario corresponds to a single event that begins at some time during the next 30 years. The consequences of that event are determined by the probability that a specific type of release will occur, the duration of that release, and the quantities of specific radionuclides that are released before the event is terminated. The frequency of (1 / 30) event per year is numerically consistent with this context, and it provides a consistent basis for comparing the risks from these scenarios with other scenarios that are initiated by specific disruptive events. The NYSERDA detection, intervention, and mitigation actions that limit the duration of each groundwater release scenario are discussed below.

8.2.2.2 Trench Levels

The hydraulic head for lateral flow through the ULT is determined by the water level in the trenches. The analyses for vertical flow through the ULT and subsequent lateral flow through the KRS are conservatively based on the assumption of a constant hydraulic gradient ($i = 1.0$), and are therefore not sensitive to the trench water levels.

Four potential trench water levels are used throughout the study. The probabilities that each water level applies at the SDA site during the 30-year study period are derived from the analyses in Section 6.7. The four water levels are:

- **High:** Level is between the WLT / ULT interface and the top of the trenches. This condition is conservatively bounded by assuming that levels are at the tops of the trenches. This condition is assigned a probability of 0.12% (i.e., 12/100 of 1%).

- **WLT / ULT:** Level is between the current leachate level and the WLT / ULT interface. This condition is conservatively bounded by assuming that levels are at the WLT / ULT interface. This condition is assigned a probability of 1.37%.
- **Current:** Level is at the current leachate level. This condition is assigned a probability of 93.51%.
- **Low:** Level is below the current leachate level and is effectively at the bottom of the trenches. This condition is assigned a probability of 5.00%.

The groundwater flow models and analyses summarized in Section 6.5 confirm that releases via lateral flow through the ULT occur at an insignificant rate if the trenches are effectively drained. Therefore, the Low Level condition does not contribute to releases through pathway (1).

It is conservatively assumed for this analysis that the Low Level condition may contribute to potential releases via the ULT / KRS pathway (2). This assumption accounts for the accumulated inventory of contaminated liquid in the soils below the trenches during the preceding 30 years of SDA operation with leachate levels at their current values and above.

8.2.2.3 Intervention and Mitigation for ULT Releases

The SDA risk assessment accounts for the fact that current NYSERDA administrative controls and processes will remain in effect throughout the 30-year study period. The analyses include credit for these processes to limit the maximum threat exposure period for groundwater releases via lateral flows through the ULT, based on the following assumptions.

- The maximum duration of the initial release will be limited by the total amount of time required for NYSERDA to detect the release, identify the release location, and stop the release or divert it from entering the affected stream.
- After the initial release occurs, it is assumed that NYSERDA will implement all necessary measures to prevent further releases via this pathway. For example, since lateral flows through the ULT are governed by the water levels in the trenches, one possible measure to prevent subsequent releases is to actively pump out any existing water and to ensure that future levels remain at or near the trench bottoms.

In effect, the combined impacts from these assumptions limit these release scenarios to single events, with release durations that are determined by the effectiveness of NYSERDA's initial detection and intervention. Longer-duration or potential repetitive releases are then prevented by the applied mitigation measures.

The scenario mitigation analyses conservatively do not account for NYSERDA intervention to actively reduce trench water levels if they are higher than current conditions for an extended period of time prior to a release (e.g., if levels are High or at the WLT / ULT interface). This assumption is required for consistent application of the trench water level analyses in Section 6.7 and the corresponding groundwater flow analyses.

Monitoring and Sampling Programs

The site Environmental Monitoring Program (Reference 8.2-1) includes the following monitoring and sampling requirements.

- Leachate levels in the 13 trench sumps are monitored quarterly.
- Groundwater levels in the 21 monitoring wells, 19 piezometers, and 9 slit-trench wells are monitored quarterly.
- Groundwater activity in the 21 monitoring wells is sampled every 6 months. Activity parameters monitored semiannually included gross alpha, gross beta, and tritium levels. Samples are checked annually for gamma-emitting radionuclides (by gamma spectroscopy), four beta-emitting radionuclides (carbon-14, iodine-129, strontium-90, and technetium-99), and volatile organic compounds.
- Water in Buttermilk Creek is sampled continuously. The sample point (WFBCTCB) is located downstream from the West Valley site at Thomas Corners Road. The composite water samples are collected biweekly and are analyzed monthly for gross alpha, gross beta, and tritium levels.
- Water in Erdman Brook is sampled quarterly. The sample point (WNERB53) is located near the northeast corner of the SDA site. The stream water samples are analyzed for gross alpha, gross beta, and tritium levels.
- Water in Frank's Creek is sampled quarterly. The sample point (WNFRC67) is located East of the northeast corner of the SDA site. The stream water samples are analyzed for gross alpha, gross beta, and tritium levels.
- Starting in 2009, water in Buttermilk Creek is sampled annually at a second location. The sampling point is located northeast from the SDA site, upstream from the confluence of Frank's Creek and Buttermilk Creek. The stream water samples are analyzed for gross alpha, gross beta, and tritium levels (Reference 8.2-2).
- Sediment in Buttermilk Creek is sampled once every 5 years. The sample point (SFTCSED) is located downstream from the West Valley site at Thomas Corners Road. Sediment samples are analyzed for gross alpha, gross beta, gamma isotopic activity, uranium isotopes, and strontium-90 (Reference 8.2-3).
- Background activity in Buttermilk Creek is sampled continuously. The sample point (WFBCKBG) is located upstream from the developed area of the site. The composite water samples are collected weekly and are analyzed monthly for gross alpha, gross beta, and tritium levels.

Conditions for NYSERDA Response

The site monitoring program requires that NYSERDA must initiate an immediate investigation of the source for a potential release if the following conditions are detected at any sampling location (Reference 8.2-4).

- A trend of 5 consecutive increases in sample activity, *or*
- 7 consecutive samples with activity above the historical mean, *or*
- 3 consecutive samples with activity more than 2 standard deviations above the historical mean, *or*
- 1 sample with activity more than 3 standard deviations above the historical mean

Buttermilk Creek Sampling Effectiveness

The QRA team reviewed historical water monitoring data from sampling point WFBCTCB, the SDA trench radionuclide inventories in Section 4.3, and results from the groundwater flow analyses in Section 6.5 to determine the sensitivity of Buttermilk Creek water samples to activity that may be released through the groundwater pathways. Tritium is the most sensitive monitored parameter, both in terms of activity levels and timing. Other relatively poorly sorbed (relatively rapidly transported) nuclides are either not analyzed in the monitoring program, or are present in the trenches in quantities that are too small to be detected more sensitively than tritium.

Measured tritium concentrations at Buttermilk Creek sample point WFBCTCB are typically in the range of 15 to 35 picoCuries per liter (pCi/L), and are only slightly higher than concentrations measured at the background location upstream from the site. The standard deviation in these measurements is approximately 100 pCi/L. Therefore, immediate NYSERDA response would be initiated if a single water sample has a measured tritium concentration of more than approximately 300 pCi/L above the historical mean. Based on the tritium concentration in the trench leachate, the calculated release rates through the groundwater pathways, and dilution in Buttermilk Creek, the QRA team determined that a measured tritium concentration of less than 300 pCi/L at sample point WFBCTCB is inconsequential with respect to potential public exposure and accumulated dose. Therefore, the team concluded that a single analysis of Buttermilk Creek water at the Thomas Corners Road sampling location is sufficient to detect a release of potential consequence for the risk assessment. In other words, a measured tritium concentration of more than 300 pCi/L above the mean at sample point WFBCTCB is sufficient to require immediate NYSERDA attention. However, concentrations at that level would remain inconsequential to public health risk if the release is successfully mitigated.

The QRA team also examined flow rates in Erdman Brook, Frank's Creek, and Buttermilk Creek to determine an approximate transit time for the first contaminated water to reach sample point WFBCTCB after it enters the streams. An average transit time of 2 days is used in these analyses to conservatively account for variable stream flow conditions.

Sample Times

The scenario mitigation analyses do not include credit for detection of activity in the groundwater wells prior to a release into the streams. The analyses account only for stream water monitoring to detect releases after they occur. This assumption accounts for the fact that stream water is monitored for activity more frequently than the wells. The analyses also show that some lateral ULT flow conditions may result in releases that begin within the semiannual well sampling period. In other words, contaminated liquid may enter the streams before it is detected by the groundwater well samples.

The scenario mitigation analyses include credit for the monthly Buttermilk Creek water samples to detect all groundwater releases from the SDA site, based on the following conclusions.

- The Buttermilk Creek water samples at Thomas Corners Road (sample point WFBCTCB) are sufficiently sensitive to detect levels of tritium that will require immediate NYSERDA investigation for any releases of potential risk consequence.
- A delay time of 2 days is applied to account for transit of the first contaminated water through the stream systems to sample point WFBCTCB.

It is assumed that the releases begin randomly in time between successive Buttermilk Creek water samples. According to this assumption, there is an equal likelihood that the release starts at any time during the 30-day period between samples. Accounting for the 2-day transit delay, the release duration until the water is sampled at location WFBCTCB is represented by a uniform probability distribution TSAMPL with a minimum value of 2 days, and a maximum value of 32 days.

NYSERDA Response and Mitigation Times

After the streams are sampled, Section 7.1.6 summarizes NYSERDA estimates for the subsequent amount of time that is required to identify and confirm the fact that a release has occurred, locate the source of the release, and stop or divert the contaminated liquid. The effective mitigation time is determined by the activities in Phases 1 through 3 in those assessments. The additional sampling in Phase 4 provides positive confirmation that the intervention is effective, but it is not required to functionally terminate the release.

The responses and times summarized in Section 7.1.6 pertain specifically to initial detection of groundwater releases through the quarterly water samples from Erdman Brook and Frank's Creek. If elevated activity is first detected in the Buttermilk Creek water samples at Thomas Corners Road, it is likely that the NYSERDA investigation process will also include confirmatory samples from that location and additional samples from all upstream points (i.e., Erdman Brook, Frank's Creek, and Buttermilk Creek upstream from Frank's Creek) to localize the source of the contamination. Processing of these samples and reporting of their results will be expedited if the initial sample activity is above the most limiting response criterion (Reference 8.2-5). These confirmatory and investigative samples insert an additional step into the three-phase process that is outlined in Section 7.1.6.

- | | |
|----------|--|
| Phase 1a | Analyze initial Buttermilk Creek samples from WFBCTCB |
| Phase 1b | Analyze confirmatory sample from WFBCTCB and investigative samples from WNERB53, WNFRC67, new upstream Buttermilk Creek sample point, and background point WFBCBKG |
| Phase 2 | Locate the groundwater release |
| Phase 3 | Initiate mitigation responses |

The NYSERDA "best" estimate from the evaluations in Section 7.1.6 is assigned a weight of 80% that it is the "true" response time for this analysis. The "lower bound" and "upper bound" estimates are each assigned weights of 10%. This process applies relatively high confidence to

the NYSERDA team's "best" estimate. General references regarding the use of expert opinion often recommend assignments of lower confidence, for example a weight of 60%. However, the estimates for this study were derived from focused discussions among the NYSERDA project team, and their bases are well documented. Many of the team members have worked at West Valley for several years and are directly involved with monitoring the SDA and coordinating emergency responses. That experience justifies generally higher confidence in the team's "best" estimates.

The following table summarizes the NYSERDA response and mitigation times, after the initial water sample is taken at Thomas Corners Road.

Phases of Groundwater Release Mitigation after Buttermilk Creek Water Sample							
Phase	Parameter	Lower Bound		Best Estimate		Upper Bound	
		Time (days)	Weight	Time (days)	Weight	Time (days)	Weight
1a	TSAMBC	1	0.10	30	0.80	45	0.10
1b	TSAMCK	1	0.10	5	0.80	14	0.10
2	TGWRLO	1	0.10	3	0.80	5	0.10
3	TGWACT	2	0.10	3	0.80	7	0.10

The uncertainty distributions for these four sequential phases are added to develop the following time distribution (TGWMIT) that is used for the NYSERDA responses to identify and stop the release, after the initial Buttermilk Creek water sample is taken.

Groundwater Release Mitigation Time after Buttermilk Creek Water Sample (days)				
5th Percentile	Median	Mean	95th Percentile	Error Factor
12.5	41.2	40.3	56.3	2.1

Analysis Results

The total duration of the release, from its start until it is terminated by the NYSERDA mitigation measures, is the sum of the sampling time (TSAMPL) and the post-sample intervention time (TGWMIT). The following table summarizes major parameters of the uncertainty distribution for the total release time.

Groundwater Lateral Flow through ULT, Release Duration before NYSERDA Mitigation (days)				
5th Percentile	Median	Mean	95th Percentile	Error Factor
30.1	58.5	57.3	77.2	1.6

This release duration is quantified in this analysis by parameter TDETMI.

8.2.2.4 Exposure Period for ULT / KRS Releases

Water samples from Erdman Brook and Frank's Creek will not detect groundwater releases via the ULT / KRS pathway. The base of the KRS outcrop emerges on the side of the Buttermilk Creek valley, at some distance above the creek bed. Thus, discharges through this pathway would enter Buttermilk Creek directly, bypassing the Erdman Brook and Frank's Creek sampling stations. Only the Buttermilk Creek water sampling station at Thomas Corners Road (WFBCTCB) and the new sample point upstream from Frank's Creek will effectively detect groundwater releases through the ULT / KRS pathway.

The analyses summarized in Section 8.2.2.3 conclude that a single sample of Buttermilk Creek water at Thomas Corners Road will satisfy the NYSERDA criteria for immediate investigation, if tritium is present in concentrations that are of potential consequence for the SDA risk assessment. A nominal 2-day delay is used for the transit time for the first contaminated water to reach sample point WFBCTCB after it enters Buttermilk Creek, although this may be somewhat conservative for normal creek flow conditions. Thus, the duration of ULT / KRS releases into Buttermilk Creek until water is sampled at WFBCTCB is represented by a uniform probability distribution TSAMPL with a minimum value of 2 days, and a maximum value of 32 days.

If increased activity is detected in Buttermilk Creek, it is assumed that NYSERDA or other local authorities will implement measures to limit exposure of all potential receptors in the affected area. These measures may include access restrictions, temporary relocation, remediation, etc. It is also assumed that implementation of these activities will be delayed by the time that is required for NYSERDA to process the sample results, confirm the release, and mobilize the necessary intervention resources.

After the water is sampled, the estimates summarized in Section 8.2.2.3 are used to account for the subsequent amount of time that is required for NYSERDA to identify the fact that a release has occurred, confirm the source of the release, and implement the necessary intervention responses. Thus, the total duration of the release, from its start until external intervention effectively prevents further exposure, is the sum of the Buttermilk Creek water sampling time (TSAMPL) and the post-sample intervention time (TGWMIT). This release duration is quantified in this analysis by parameter TDETMI, as summarized in Section 8.2.2.3.

8.2.3 Analyzed Scenarios

A total of four scenarios are analyzed for these releases. Three scenarios involve lateral flows through the ULT pathway (1), and one scenario involves flow through the ULT / KRS pathway (2). The following items describe each scenario and document specific elements of its analysis.

8.2.3.1 Lateral Flow through ULT, Water Level High

Probability Weight = 0.0012

This initial condition has a probability of 0.12% that it applies at the SDA during the 30-year period of this study.

The groundwater flow models and analyses summarized in Section 6.5 provide an uncertainty distribution for the concentration-weighted fluid flow rate into Erdman Brook or Frank's Creek under these conditions. That flow rate is quantified in this analysis by parameter ULTLAT1 (cubic feet / second).

The release will continue until it is detected and mitigated by NYSERDA intervention. The release duration is quantified by parameter TDETM1 (days).

This analysis is based on the assumption that the NYSERDA mitigation measures will effectively prevent all future releases through this pathway, after the initial release occurs. It is assumed that this release occurs randomly at some time during the 30-year period of this study.

The analysis of this scenario includes the following factors.

- Single release occurrence in 30 years (1 / 30) (event / year)
- Probability that trench levels are High (0.0012)
- Concentration-weighted fluid flow rate (ULTLAT1) (cubic feet / second)
- NYSERDA detection and mitigation time (TDETM1) (days)

8.2.3.2 Lateral Flow through ULT, Water Level at WLT / ULT Interface

Probability Weight = 0.0137

This initial condition has a probability of 1.37% that it applies at the SDA during the 30-year period of this study.

The only other difference between this scenario and that summarized in Section 8.2.3.1 is the concentration-weighted fluid flow rate for the hydraulic head under these conditions. That flow rate is quantified in this analysis by parameter ULTLAT2.

The analysis of this scenario includes the following factors.

- Single release occurrence in 30 years (1 / 30) (event / year)
- Probability that trench levels are at the WLT / ULT interface (0.0137)
- Concentration-weighted fluid flow rate (ULTLAT2) (cubic feet / second)
- NYSERDA detection and mitigation time (TDETM1) (days)

8.2.3.3 Lateral Flow through ULT, Water Level at Current Conditions

Probability Weight = 0.9351

This initial condition has a probability of 93.51% that it applies at the SDA during the 30-year period of this study.

The only other difference between this scenario and that summarized in Section 8.2.3.1 is the concentration-weighted fluid flow rate for the hydraulic head under these conditions. That flow rate is quantified in this analysis by parameter ULTLAT3.

The analysis of this scenario includes the following factors.

- Single release occurrence in 30 years (1 / 30) (event / year)
- Probability that trench levels are at the current levels (0.9351)
- Concentration-weighted fluid flow rate (ULTLAT3) (cubic feet / second)
- NYSERDA detection and mitigation time (TDETM) (days)

8.2.3.4 Vertical Flow through ULT and Lateral Flow through KRS

The groundwater flow models and analyses for this pathway summarized in Section 6.5 are performed under conditions that are not sensitive to the initial water level in the trenches. Therefore, the results from those analyses apply for all water levels. The analyses provide an uncertainty distribution for the concentration-weighted fluid flow rate into Buttermilk Creek. That flow rate is quantified in this analysis by parameter ULTKRS (cubic feet / second).

The release will continue until it is detected by NYSERDA and mitigated by external intervention to prevent further receptor exposures. The release duration is quantified by parameter TDETM (days).

This analysis is based on the assumption that the external intervention will effectively prevent all future exposures from releases through this pathway, after the initial release occurs. It is assumed that this release occurs randomly at some time during the 30-year period of this study.

The analysis of this scenario includes the following factors.

- Single release occurrence in 30 years (1 / 30) (event / year)
- Concentration-weighted fluid flow rate (ULTKRS) (cubic feet / second)
- NYSERDA detection and external intervention time (TDETM) (days)

8.2.4 General Characteristics of Releases

Table 8.2-1 summarizes the four scenarios that contribute to the frequency of Release Mechanism 1, as described in the preceding section.

This release mechanism involves releases of radioactive liquids to Erdman Brook, Frank's Creek, or Buttermilk Creek via groundwater flows through the ULT or the ULT / KRS layers. The specific releases are characterized more completely in Section 9.

8.2.5References

8.2-1. "SDA Annual Site Environmental Monitoring Report", NYSERDA, 2007

8.2-2. E-mail communication, T. H. Attridge, NYSERDA, to J. W. Stetkar, April 30, 2009

8.2-3. E-mail communication, M. J. Willett, NYSERDA, to J. W. Stetkar, July 31, 2008

8.2-4. E-mail communications, T. H. Attridge, NYSERDA, to J. W. Stetkar, May 4, 2009 and
May 5, 2009

8.2-5. E-mail communication, T. H. Attridge, NYSERDA, to J. W. Stetkar, May 7, 2009

Table 8.2-1. Scenarios for Release Mechanism 1

Initial Trench Water Level	Threat Condition – Damage Scenario	Scenario Quantification		
		Frequency (event / year)	Concentration-Release Rate (cubic feet / second)	Release Duration (days)
High	Groundwater lateral flow through ULT; NYSERDA detection via Buttermilk Creek water sampling; NYSERDA mitigation	(1 / 30)	0.0012 * ULTLAT1	TDETM1
WLT / ULT Interface	Groundwater lateral flow through ULT; NYSERDA detection via Buttermilk Creek water sampling; NYSERDA mitigation	(1 / 30)	0.0137 * ULTLAT2	TDETM1
Current	Groundwater lateral flow through ULT; NYSERDA detection via Buttermilk Creek water sampling; NYSERDA mitigation	(1 / 30)	0.9351 * ULTLAT3	TDETM1
All	Groundwater vertical flow through ULT and lateral flow through KRS; NYSERDA detection via Buttermilk Creek water sampling; External intervention to limit receptor exposure	(1 / 30)	ULTKRS	TDETM1

8.3 RELEASE MECHANISM 2

Release Mechanism 2 involves liquid releases from the waste trenches via groundwater flows through the Weathered Lavery Till soil layer.

8.3.1 Threat Conditions

The scenarios for Release Mechanism 2 involve lateral groundwater flows through the WLT soil layer near the surface of the SDA site. These natural processes transport liquids and radioactive leachate from the waste trenches to discharge points along the banks of Erdman Brook and Frank's Creek.

Releases into Frank's Creek originate primarily from Trenches 1/2 and 8 at the East side of the site. Releases into Erdman Brook originate from Trenches 1/2, 3, 4, and 5 at the North end of the site. The analyses also account for contributions from lateral flows through the spaces between trenches (e.g., between Trench 3 and Trenches 1/2, and between Trench 9 and Trench 8).

8.3.2 Analysis Framework

A detailed logic model is not needed to evaluate possible conditions that may affect the progression of these scenarios, or to support their quantification. The release flow rates and the corresponding radionuclide concentrations are derived from the groundwater flow models described in Section 6.5.

The scenarios are also based on the following information, assumptions, and supporting analyses.

8.3.2.1 Release Scenario Context

As discussed in Section 8.2.2.1, each groundwater release scenario is quantified with a frequency of one event during the 30-year study period. The groundwater analyses in Section 6.5 account for the probabilities that each relevant combination of water levels and soil conditions apply at the site. The analyses evaluate the likelihood that a release will occur within the next 30 years if those conditions apply. For each set of site conditions that support a release, the analyses then quantify the rate at which the contaminated water will flow into the adjoining streams and the associated radionuclide concentrations in the released liquid. The risk models account for NYSERDA detection, intervention, and mitigation actions that limit the duration of the release and the corresponding volume of contaminated liquid that flows into the streams.

8.3.2.2 Trench Levels

Four potential trench water levels are used throughout the study. The probabilities that each water level applies at the SDA site during the 30-year study period are derived from the analyses in Section 6.7. The four water levels are:

- **High:** Level is between the WLT / ULT interface and the top of the trenches. This condition is conservatively bounded by assuming that levels are at the tops of the trenches. This condition is assigned a probability of 0.12% (i.e., 12/100 of 1%).
- **WLT / ULT:** Level is between the current leachate level and the WLT / ULT interface. This condition is conservatively bounded by assuming that levels are at the WLT / ULT interface. This condition is assigned a probability of 1.37%.
- **Current:** Level is at the current leachate level. This condition is assigned a probability of 93.51%.
- **Low:** Level is below the current leachate level and is effectively at the bottom of the trenches. This condition is assigned a probability of 5.00%.

Lateral flow through the WLT can occur only when water levels in the waste trenches are above the interface between the WLT and ULT soil layers. Therefore, only the High Level condition contributes to these releases.

8.3.2.3 Intervention and Mitigation for WLT Releases

This analysis includes credit for the same NYSERDA detection, intervention, and mitigation responses that are described and evaluated in Section 8.2.2.3.

The scenario mitigation analyses conservatively do not account for NYSERDA intervention to actively reduce trench water levels if they are above the WLT / ULT interface for an extended period of time prior to a release. This assumption is required for consistent application of the trench water level analyses in Section 6.7 and the corresponding groundwater flow analyses.

The scenario mitigation analyses do not include credit for detection of activity in the groundwater wells prior to a release into the streams. The analyses account only for stream water monitoring to detect releases after they occur. This assumption accounts for the fact that stream water is monitored for activity more frequently than the wells. The analyses also show that lateral flows through the WLT result in releases that begin within much shorter intervals than the semiannual well sampling period. In other words, contaminated liquid will enter the streams before it is detected by the groundwater well samples.

The duration of these releases is quantified in this analysis by parameter TDETMI.

8.3.3 Analyzed Scenarios

Only one scenario is analyzed for these releases.

Lateral flows through the WLT can occur only during conditions when the trench water levels are High. This initial condition has a probability of 0.12% that it applies at the SDA during the 30-year period of this study.

The groundwater flow models and analyses summarized in Section 6.5 provide an uncertainty distribution for the concentration-weighted fluid flow rate into Erdman Brook or Frank's Creek

under these conditions. That flow rate is quantified in this analysis by parameter WLTAT (cubic feet / second).

The release will continue until it is detected and mitigated by NYSERDA intervention. The release duration is quantified by parameter TDEMI (days).

This analysis is based on the assumption that the NYSERDA mitigation measures will effectively prevent all future releases through this pathway, after the initial release occurs. It is assumed that this release occurs randomly at some time during the 30-year period of this study.

The analysis of this scenario includes the following factors.

- Single release occurrence in 30 years (1 / 30) (event / year)
- Probability that trench levels are High (0.0012)
- Concentration-weighted fluid flow rate (WLTAT) (cubic feet / second)
- NYSERDA detection and mitigation time (TDEMI) (days)

8.3.4 General Characteristics of Releases

Table 8.3-1 summarizes the scenario that contributes to the frequency of Release Mechanism 2, as described in the preceding section.

This release mechanism involves releases of radioactive liquids to Erdman Brook or Frank's Creek via groundwater flows through the WLT layer. The specific releases are characterized more completely in Section 9.

Table 8.3-1. Scenario for Release Mechanism 2			
Initial Trench Water Level	Threat Condition – Damage Scenario	Scenario Quantification	
		Frequency (event / year)	Concentration-Release Rate (cubic feet / second)
High	Groundwater lateral flow through WLT; NYSERDA detection via Buttermilk Creek water sampling; NYSERDA mitigation	(1 / 30)	0.0012 * WLT _{LAT} TDETM _I

8.4 RELEASE MECHANISM 3

Release Mechanism 3 involves liquid overflows of the waste trenches and releases via surface water runoff.

Radioactive material releases via groundwater flows through the Unweathered Lavery Till and the Weathered Lavery Till are evaluated by Release Mechanisms 1 and 2. Release Mechanism 3 accounts for disruptive events that fill the trenches until they overflow onto the SDA surface.

8.4.1 Threat Conditions

All scenarios for Release Mechanism 3 are initiated by precipitation or severe storms. Significant water intrusion into the waste trenches can occur only if the geomembrane covers are removed from a large portion of the SDA surface area. The compacted clay caps also provide an effective secondary barrier against water intrusion, if they are intact.

Three general threat conditions contribute to these release scenarios.

- (1) Precipitation occurs while the geomembranes are functionally disabled due to a preceding condition, and the trench caps are intact. Examples of preceding conditions that contribute to this site configuration include geomembrane damage due to wildfires, gas pipeline fires, slope gully erosion within the SDA site boundary, and planned replacement activities that remove the old geomembranes before the new membranes are installed.
- (2) A severe windstorm or tornado damages the geomembranes. Substantial precipitation occurs during the damaging storm, and additional precipitation occurs during the period before the geomembranes are repaired or replaced.
- (3) Precipitation occurs while the geomembranes are functionally disabled due to a preceding condition, and the trench caps are physically disrupted. Examples of preceding conditions that contribute to this site configuration include damage from aircraft crashes, meteorite impacts, and earthquakes.

These threats account for storms that are the cause for geomembrane damage, and storms that are not directly correlated to the damage. They also account for two possible conditions of the trench caps, which affect the rate at which water may enter the trenches.

8.4.2 Analysis Framework

8.4.2.1 Logic Model

Figure 8.4-1 illustrates the logic model framework that is used to evaluate the contributors to these releases.

IE

The "IE" entry corresponds to each of the three general threat conditions that is summarized in Section 8.4.1. These are the "initiating events" that trigger the scenario evolution. Specific conditions that apply to the analysis of each threat are described in Section 8.4.3.

Trench Level

The first branch point in Figure 8.4-1 accounts for the water level in the trenches when the initiating event occurs. The four water levels are consistent with those used throughout the study. The probabilities that each water level applies at the SDA site during the 30-year study period were derived from the analyses that are documented in Section 6.7. The four water levels are:

- **High:** Level is between the WLT / ULT interface and the top of the trenches. This condition is conservatively bounded by assuming that levels are at the tops of the trenches. This condition is assigned a probability of 0.12% (i.e., 12/100 of 1%).
- **WLT / ULT:** Level is between the current leachate level and the WLT / ULT interface. This condition is conservatively bounded by assuming that levels are at the WLT / ULT interface. This condition is assigned a probability of 1.37%.
- **Current:** Level is at the current leachate level. This condition is assigned a probability of 93.51%.
- **Low:** Level is below the current leachate level and is effectively at the bottom of the trenches. This condition is assigned a probability of 5.00%.

Caps Intact

This branch point determines whether the trench clay caps are intact or physically disrupted when the initiating event occurs. It is a logical "switch" that depends on the particular initiating event. For example, the caps are intact for Threat Condition 1 and Threat Condition 2 (i.e., the "Yes" path applies for those threats). The caps are disrupted for Threat Condition 3 (i.e., the "No" path applies for that threat).

The analyses assume that the status of the trench caps is important only for conditions when the trench levels are High. Therefore, this branch point is bypassed (N/A) for all other level conditions. The bases for this assumption are discussed below.

Caps Erode

If the trench caps are initially intact, this branch point evaluates whether the storm is severe enough to erode the caps and expose the trenches to direct water intrusion.

If the caps do not erode and remain an effective barrier, the "No" path from this branch point is assigned to a successful scenario end state. Insufficient water enters the trenches to cause an overflow. If the storm is severe enough to erode the caps, the trenches will overflow, and the "Yes" path is assigned to a release.

8.4.2.2 Supporting Information and Assumptions

The assumptions regarding initial levels in the trenches and the corresponding probabilities for those levels are discussed above. The analyses are also based on the following information and additional assumptions.

14-Day Threat Exposure Period

These potential releases depend on both the storm severity (rate of precipitation) and the duration of the storm period (cumulative precipitation). A 14-day interval is used as the maximum threat exposure period in these analyses. Thus, cumulative precipitation is evaluated over a 14-day interval. However, the impacts from severe storms are evaluated over shorter intervals (e.g., 24 to 48 hours) to account for the effects from potentially damaging erosion.

The 14-day period is broadly based on NYSERDA evaluations of similar scenarios that are summarized in Section 7.1.5. For example, the lower bound for the time to fully mitigate trench overflows was estimated to be approximately 18 days, which includes sufficient pumping of the trenches to lower levels below the WLT / ULT interface. It is apparent that the NYSERDA team's evaluation of those scenarios focused primarily on detection and mitigation of subsurface flows through the WLT layer. It is expected that personnel (including site security patrols) will more quickly discover conditions that result in overtopping of the trenches, especially if those conditions are associated with severe storms. Therefore, a 14-day exposure period provides a reasonable bound for these analyses. It accounts for the cumulative effects from light to moderate precipitation that might not otherwise cause significant concern. It also covers multi-day storms and consecutive weekly storm periods that may deliver significant precipitation before NYSERDA can fully implement the necessary mitigation measures.

Precipitation to Fill Trenches

If the trench levels are High, it is assumed that the levels are essentially at the tops of the trenches. Under these conditions, it is assumed that total precipitation of 1 inch, or more, during the 14-day exposure period will overflow the trenches.

If the trench levels are at the WLT / ULT interface and the clay caps are damaged, the hydrologic analyses in Section 6.6.1 indicate that approximately 8.7 inches of precipitation is required to fill the trenches to their tops. This estimate is rounded to 9 inches for these analyses. Thus, under these conditions, it is assumed that total precipitation of 9 inches, or more, during the 14-day exposure period will overflow the trenches.

If the trench levels remain at their current values and the clay caps are damaged, the hydrologic analyses in Section 6.6.1 indicate that approximately 24.7 inches of precipitation is required to fill the most limiting trench (i.e., Trench 13). This estimate is rounded to 25 inches for these analyses, and it is applied to all trenches.

If the trenches are fully drained and the clay caps are damaged, approximately 47.1 inches of precipitation is required to fill the trenches to their tops. This estimate is rounded to 47 inches for these analyses.

Trench Cap Erosion

Section 6.4 summarizes analyses that were performed to evaluate the rates of trench cap erosion during severe precipitation events when the geomembranes are not in place. Damaging erosion (i.e., to a depth that exposes the top surface of the waste material) requires precipitation rates of at least 4 inches in 24 hours, under the most limiting analysis conditions. Lower precipitation rates will not cause significant erosion.

Figure 8.4-1 shows that the status of the trench caps and the potential impacts from cap erosion are evaluated only during scenarios when the trench levels are initially High. As noted above, it is assumed that the trenches will overflow under these conditions if at least 1 inch of additional water enters the trenches. This water may result from a single severe storm, or it may accumulate from light precipitation over the entire 14-day exposure period. If the precipitation rate is relatively low, the trench caps provide an effective barrier against water intrusion, and the trenches will not overflow. However, if a severe storm occurs, the caps may erode, and the trenches will overflow. Therefore, due to the very small margins that exist when the trench levels are High, it is important to explicitly evaluate the likelihood that the initiating event is severe enough to damage the caps. If the caps are initially intact, and the precipitation rate is not high enough to cause erosive damage, it is assumed that the surface water will be effectively removed and the trenches will not overflow.

The status of the trench caps and the potential impacts from cap erosion are not evaluated for the other three initial trench water levels. This modeling simplification is based on the amounts of precipitation that are required to fill the trenches under these conditions and reviews of the regional precipitation data.

For example, if levels are initially at the WLT / ULT interface, approximately 9 inches of precipitation is required to overflow the trenches. The regional weather records show that this amount of cumulative precipitation has occurred four times within a 14-day interval since 1922 (October 1974 at Buffalo, September 1977 at Dunkirk, November 1985 at Dunkirk, and October 1993 at Buffalo). The maximum 14-day total precipitation at the West Valley site since 1991 is approximately 6.5 inches (September 2004). The historical experience shows that the largest multi-day cumulative precipitation totals almost always involve severe single-day or 2-day storms. In other words, the largest 14-day cumulative precipitation periods typically include a severe 1-day or 2-day storm, preceded or followed by days with much lower accumulations. Thus, if the 14-day total precipitation exceeds 9 inches, it is quite likely that this period will include at least one rather intense storm.

The analyses were simplified by conservatively assuming that 14-day cumulative precipitations of 9 inches or more will cause sufficient erosion of the trench caps to allow water intrusion into the trenches. Therefore, the status of the trench caps is not questioned when initial water levels are at or below the WLT / ULT interface, and substantial precipitation is required to fill the trenches. This simplification introduces some numerical conservatism because some 14-day precipitation totals may result from steady, moderate precipitation at rates that do not cause severe erosion. This situation is more likely at the lower end of the range. For example, a 9-inch accumulation could conceivably result from an average precipitation rate of approximately 0.65-inch per day over the entire 14-day interval. However, this type of weather pattern is not supported by the historical experience, and it is likely that more intense storms will contribute to this total.

Combined Analyses for Current and Low Water Levels

Approximately 47 inches of precipitation is required to fill the trenches if they are fully drained. There is a 5% probability that this condition applies at the SDA during the 30-year period of this study. Approximately 25 inches of precipitation is required to fill the trenches from their current levels. There is a 93.51% probability that this condition applies. The analyses were simplified by combining these two level conditions and applying the more limiting requirements. In particular, the combined probability of 98.51% was assigned to the Current level condition. This simplification avoids the need to separately evaluate the low probability Low level condition. It introduces a very small amount of conservatism, because the likelihood of 47 inches of precipitation in 14 days is much smaller than the likelihood of 25 inches. However, both frequencies are quite small, and the amount of conservatism from this simplification is numerically insignificant.

Buttermilk Creek Flow

Precipitation determines the rate at which the trenches fill and the amount of liquid that is released if the trenches overflow. The rate of precipitation also affects surface water runoff into the local stream system (i.e., the Buttermilk Creek basin) and the corresponding stream flows. Thus, as the amount of precipitation increases, more contaminated liquid may be released from the waste trenches, but the amount of dilution flow in the adjacent streams is also correspondingly higher. The analyses evaluate both conditions to account for flow of contaminated liquid entering the stream system, dilution of the activity concentrations in the stream water, and the consequential dose rates at each receptor location.

The QRA team developed a hydrologic model of the stream system to evaluate flow rates at various points along Buttermilk Creek for several rainfall events. Flows were determined for storm events with precipitation rates of 2, 4, 8, 12, and 24.9 inches in a 24-hour period. Recorded flow data indicate that the normal average flow rate in Buttermilk Creek at its confluence with Cattaraugus Creek is approximately 53 cubic feet per second (cfs). Meteorological records from the site and the regional weather stations indicate that the average precipitation for the Buttermilk Creek basin is approximately 40 inches per year. Figure 8.4-2 plots the flow rate in Buttermilk Creek as a function of precipitation during a 24-hour period. The flow values for precipitation rates of 2 inches and higher are derived from the hydrologic models for 24-hour storm events. The flow values for precipitation rates of less than 2 inches are determined by extrapolating the storm flows down to the average creek flow of 53 cfs at the corresponding average daily precipitation of slightly more than 1/10 of an inch.

The results depicted in Figure 8.4-2 are based on evaluation of actual basin area and topography, with the added conservative assumption that there is no capacity for water loss or storage within the basin when the evaluated 24-hour storms begin. This means that basin soil is assumed to be saturated at the beginning of the rainfall and that none of the precipitation is lost from the surface system through evaporation, plant uptake, or infiltration into groundwater. Thus, all of the precipitation falling in the basin during each evaluated storm, small or large, becomes runoff that eventually reaches the confluence of Buttermilk Creek and Cattaraugus Creek.

Use of the correlation shown in Figure 8.4-2 introduces a source of conservatism into the overall risk results from these scenarios because the Buttermilk Creek flow dilutes the released activity before the contaminated liquid reaches each receptor. The QRA team did not attempt

to estimate the amount of conservatism or to correct for it. However, it is noteworthy that the results for scenarios that involve rather mild extended precipitation are generally more conservative than the results for scenarios that are determined primarily by severe storm events. For example, more realistic evaluation of antecedent conditions (e.g., soil moisture, infiltration, plant uptake, etc.) would produce water losses within the basin that are a much more significant fraction of the potential runoff from a small storm than from a larger storm.

8.4.3 Analyzed Scenarios

A total of nine scenarios are analyzed for these releases. The following items describe each scenario and document specific elements of its analysis.

8.4.3.1 Water Level High

Probability Weight = 0.0012

This initial condition has a probability of 0.12% that it applies at the SDA during the 30-year period of this study.

Threat Condition 1

Precipitation occurs while the geomembranes are functionally disabled due to a preceding condition, and the trench caps are intact.

The trench caps are initially intact for these conditions. Therefore, the Caps Intact branch in Figure 8.4-1 is set to the "Yes" position.

The trenches will overflow if at least 1 inch of water enters them. Therefore, under these conditions, the initiating event for Threat Condition 1 accounts for any cumulative precipitation that exceeds 1 inch in a 14-day period. However, only some of these events have precipitation rates that are severe enough to erode the trench caps.

Geomembrane Unavailability

This initial site configuration may occur if the geomembranes are not intact, but the trench surfaces remain undisturbed. Section 7.2 evaluates the following types of causes for this condition.

- Wildfire
- Gas pipeline fire
- Slope gully erosion beyond the SDA fence
- Planned replacement of the VLDPE membranes
- Planned replacement of the XR-5 membranes

These causes for geomembrane unavailability are combined and are quantified in this analysis by parameter GEOMUI.

Trench Cap Erosion

Section 7.3 evaluates the frequency of storms with precipitation rates that are sufficient to breach the trench caps. Less intense precipitation will not erode the caps. Therefore, the only events of concern in this analysis of Threat Condition 1 are 24-hour or 48-hour storms that are severe enough to cause significant erosion. If the caps are eroded to the depth that exposes the surface of the waste material (i.e., the tops of the trenches), it is assumed that the trenches will overflow and a release will occur. These conditions are assigned to the "Yes" path from the Caps Erode branch in Figure 8.4-1.

The composite effects from the cap erosion fragilities, the storm intensities, and the storm frequencies are integrated in Section 7.3 to derive the frequency of trench cap failures due to storm damage. This frequency essentially accounts for the fraction of all initial precipitation events that result in the "Yes" path from the Caps Erode branch in Figure 8.4-1. That frequency is quantified in this analysis by parameter IPRECF.

Scenario Frequency

The frequency of this scenario is the product of three contributors.

- Probability that trench levels are High (0.0012)
- Unavailability of the geomembranes, with the trench caps undisturbed (GEOMUI)
- Frequency of precipitation events that are severe enough to erode the trench caps (IPRECF)

Trench Liquid Releases and Dilution

The frequency of this scenario is determined by 24-hour and 48-hour storms. Precipitation rates of less than 4 inches in 48 hours are not severe enough to erode the trench clay caps for any of the evaluated soil conditions. In addition to determining the frequency of these events, the supporting meteorological data are also used to derive conditional probabilities for various precipitation rates, as shown in the table below. For example, the data show that approximately 19% of these storms have precipitation rates of 4 to 5 inches in a 48-hour period; approximately 9% of the storms have precipitation rates of 5 to 6 inches; etc.

This scenario occurs during conditions when the trench levels are High. The analyses in Section 6.6.1 indicate that each inch of precipitation results in a total trench overflow liquid volume of 19,925 cubic feet. The release volumes shown below are computed for the upper bound of each precipitation range. For example, 5 inches of precipitation results in an overflow volume of $5 * 19,925 = 99,625$ cubic feet. The equivalent trench overflow rate (parameter FR) is determined by dividing this release volume by the 48-hour duration of the storm period.

The flow rate in Buttermilk Creek is determined from Figure 8.4-2, using the maximum 24-hour precipitation rate for each range. For example, uniform storm intensity is assumed so that precipitation of 5 inches in 48 hours is equivalent to an average precipitation rate of 2.5 inches in 24 hours. The corresponding creek flow rate for a 2.5-inch, 24-hour rainfall from Figure 8.4-2 is 1,964 cfs. A maximum creek flow rate of 9,581 cfs is used for all precipitation rates that exceed 25 inches in 48 hours to provide a conservative lower bound for the dilution flows during those very severe events.

The ratio (FR / FD) determines an effective dilution factor for the contaminated liquid that is released during this scenario. The tabulated results show that this factor is relatively insensitive to the precipitation rate, because both the overflow volume and the creek flow are directly proportional to the amount of precipitation. The conditional probability distribution for (FR / FD) is quantified in this analysis by parameter FRFD31.

Trench Overflow Scenario 3-1					
Trench Liquid Releases and Buttermilk Creek Dilution Flows					
48-Hour Precipitation Range (inches)	Probability	Trench Overflow Volume (cu. ft.)	Trench Overflow Rate (FR, cfs)	Buttermilk Creek Flow Rate (FD, cfs)	FR / FD
4 – 5	1.89E-01	99,625	0.577	1,964	2.94E-04
5 – 6	8.77E-02	119,550	0.692	2,347	2.95E-04
6 - 7.5	6.33E-02	149,438	0.865	2,914	2.97E-04
7.5 - 10	2.66E-01	199,250	1.153	3,869	2.98E-04
10 – 12.5	1.39E-01	249,063	1.441	4,823	2.99E-04
12.5 - 15	6.95E-02	298,875	1.730	5,772	3.00E-04
15 – 17.5	4.03E-02	348,688	2.018	6,723	3.00E-04
17.5 - 20	2.79E-02	398,500	2.306	7,676	3.00E-04
20 – 22.5	2.53E-02	448,335	2.595	8,628	3.01E-04
22.5 - 25	2.30E-02	498,125	2.883	9,581	3.01E-04
> 25	6.93E-02	500,000	2.894	9,581	3.02E-04

Release Duration

This scenario evaluates releases that are caused by 24-hour and 48-hour storms. The supporting meteorological data indicate that storms with durations of one day, or less, account for approximately 30% of the scenario frequency. Storms with durations between one day and two days account for approximately 70% of the frequency. The trench release rate analyses, Buttermilk Creek flow analyses, and dose analyses for this scenario conservatively use a 2-day duration for all releases.

Threat Condition 2

A severe windstorm or tornado damages the geomembranes. Substantial precipitation occurs during the damaging storm, and additional precipitation occurs during the period before the geomembranes are repaired or replaced.

The geomembranes are initially intact for these conditions. The trench caps are also intact. Therefore, the Caps Intact branch in Figure 8.4-1 is initially set to the "Yes" position. Except for the high water levels in the trenches, the SDA is in its normal configuration.

Contributing Storm Events

This threat condition accounts for severe wind storms. In particular, it includes the following events.

- Straight-line winds with gust speeds that exceed 115 mph
- Tornadoes of Fujii intensity F2 (wind speed 113 – 157 mph), or higher

The high wind frequencies are quantified in Section 5.3, and the tornado frequencies are quantified in Section 5.4. The combined frequency of these storms is quantified in this analysis by parameter IWITOR.

According to the analyses in Section 7.2, these storms are assumed to severely damage the geomembranes. Therefore, the trench surfaces are exposed as a direct and immediate consequence of the initiating event.

Historical data to determine the expected amount of precipitation during severe wind storms and tornadoes were not readily available from the regional weather stations. Tornadoes occur with some regularity throughout this region of western New York State and northwestern Pennsylvania. However, tornadoes and their associated storm cells are very localized phenomena. The available records were examined to determine whether any of the tornado dates correspond to severe precipitation dates at the reporting weather stations. No direct correlations were found. However, it is well known that tornadoes are most often produced by very severe weather cells and are often accompanied by thunderstorms. Although the available weather records do not provide conclusive data for the amount of precipitation during a tornado, the records do contain numerous severe thunderstorms. The majority of these storms produce rainfall totals in the range of 2 to 3 inches. A very small fraction of the storms have resulted in 24-hour rainfall accumulations in the range of 4 to 6 inches.

The QRA team assigned the following subjective probability distribution to account for the amount of precipitation that may occur during a severe wind storm or tornado. The assigned probabilities for accumulations of 6 inches or more are conservative, compared with the available regional experience. However, they span anecdotal experience from very severe storms and tornadoes that have occurred in other regions of the United States.

Precipitation During Severe Wind Storms (QRA Team Estimates)	
Precipitation during Storm Event (inches)	Probability
3	0.75
6	0.15
9	0.08
12	0.02

Trench Cap Erosion

It is conservatively assumed for this analysis that the precipitation rate during a severe wind storm or tornado is sufficient to cause extensive erosion of the trench caps. The analyses in Section 6.4 indicate that damaging erosion is possible at precipitation totals of 4 inches in 24 hours under the most limiting soil conditions. The precipitation events were evaluated with nominal durations of 2, 4, 6, 8, and 10 hours. Thus, without better data or more detailed analyses, it is reasonable to assume that very intense rainfalls during these storms may cause significant erosion, despite their short durations.

Based on this assumption, the Caps Intact branch in Figure 8.4-1 is reset to the "No" position for these storms.

Scenario Frequency

These storms contribute directly to releases from the trenches because they severely damage the geomembranes and have sufficient precipitation intensities to breach the trench caps. The frequency of this scenario is the product of two contributors.

- Probability that trench levels are High (0.0012)
- Frequency of severe wind storms and tornadoes (IWITOR)

Trench Liquid Releases and Dilution

The frequency of this scenario is determined by 24-hour storms. Precipitation rates of less than 4 inches in 24 hours are not severe enough to erode the trench clay caps for any of the evaluated soil conditions. In addition to determining the frequency of these events, the supporting meteorological data are also used to derive conditional probabilities for various precipitation rates, as shown in the table below. For example, the data show that approximately 75% of these storms have precipitation rates of 3 to 6 inches in a 24-hour period; approximately 15% of the storms have precipitation rates of 6 to 9 inches; etc.

This scenario occurs during conditions when the trench levels are High. The analyses in Section 6.6.1 indicate that each inch of precipitation results in a total trench overflow liquid volume of 19,925 cubic feet. The release volumes shown below are computed for the upper bound of each precipitation range. For example, 6 inches of precipitation results in an overflow

volume of $6 * 19,925 = 119,550$ cubic feet. The equivalent trench overflow rate (parameter FR) is determined by dividing this release volume by the 24-hour duration of the storm period.

The flow rate in Buttermilk Creek is determined from Figure 8.4-2, using the maximum precipitation rate for each range. For example, precipitation of 6 inches in 24 hours produces a creek flow rate of 4,633 cfs. A maximum creek flow rate of 9,198 cfs is used for all precipitation rates that exceed 12 inches in 24 hours to provide a conservative lower bound for the dilution flows during those very severe events.

The ratio (FR / FD) determines an effective dilution factor for the contaminated liquid that is released during this scenario. The tabulated results show that this factor is relatively insensitive to the precipitation rate, because both the overflow volume and the creek flow are directly proportional to the amount of precipitation. The conditional probability distribution for (FR / FD) is quantified in this analysis by parameter FRFD32.

Trench Overflow Scenario 3-2					
Trench Liquid Releases and Buttermilk Creek Dilution Flows					
24-Hour Precipitation Range (inches)	Probability	Trench Overflow Volume (cu. ft.)	Trench Overflow Rate (FR, cfs)	Buttermilk Creek Flow Rate (FD, cfs)	FR / FD
3 - 6	7.50E-01	119,550	1.384	4,633	2.99E-04
6 - 9	1.50E-01	179,325	2.076	6,914	3.00E-04
9 - 12	8.00E-02	239,100	2.767	9,198	3.01E-04
> 12	2.00E-02	250,000	2.894	9,198	3.15E-04

Release Duration

This scenario evaluates releases that are caused by very severe wind storms and tornadoes. The duration of these storms is typically less than 24 hours. The trench release rate analyses, Buttermilk Creek flow analyses, and dose analyses for this scenario use a 1-day duration for all releases.

Threat Condition 3

Precipitation occurs while the geomembranes are functionally disabled due to a preceding condition, and the trench caps are physically disrupted.

The trench caps are physically disrupted for these conditions, and they do not provide an effective barrier against water intrusion. Therefore, the Caps Intact branch in Figure 8.4-1 is set to the "No" position.

The trenches will overflow if at least 1 inch of water enters them. Therefore, under these conditions, the initiating event for Threat Condition 3 accounts for any cumulative precipitation that exceeds 1 inch in a 14-day period. The frequency of these events is quantified in this analysis by parameter IPRE1.

Geomembrane Unavailability

This initial site configuration may occur if the geomembranes are not intact, and the trench surfaces are physically disturbed. Section 7.2 evaluates the following types of causes for this condition.

- General aviation aircraft crash
- Commercial aircraft crash
- Military aircraft crash
- Meteorite impact
- Seismic event with acceleration ≥ 0.25 g

These causes for geomembrane unavailability are combined and are quantified in this analysis by parameter GEOMUD.

Scenario Frequency

The frequency of this scenario is the product of three contributors.

- Probability that trench levels are High (0.0012)
- Unavailability of the geomembranes, with the trench caps disturbed (GEOMUD)
- Frequency of precipitation that exceeds 1 inch accumulation in 14 days (IPRE1)

Trench Liquid Releases and Dilution

The frequency of this scenario is determined by precipitation that occurs during the 14-day exposure period. In addition to determining the frequency of these events, the supporting meteorological data are also used to derive conditional probabilities for various precipitation rates, as shown in the table below. For example, the data show that approximately 84% of all 14 consecutive day periods have cumulative precipitation of 1 to 3 inches; approximately 14% of the 14-day periods have cumulative precipitation of 3 to 6 inches; etc.

This scenario occurs during conditions when the trench levels are High. The analyses in Section 6.6.1 indicate that each inch of precipitation results in a total trench overflow liquid volume of 19,925 cubic feet. The release volumes shown below are computed for the upper bound of each precipitation range. For example, 3 inches of precipitation results in an overflow volume of $3 * 19,925 = 59,775$ cubic feet. The equivalent trench overflow rate (parameter FR) is determined by dividing this release volume by the 14-day duration of the exposure period.

The flow rate in Buttermilk Creek is determined from Figure 8.4-2, using the maximum 24-hour precipitation rate for each range. For example, precipitation of 3 inches uniformly distributed over 14 days is equivalent to an average precipitation rate of approximately 0.2 inches in 24 hours. The corresponding creek flow rate from Figure 8.4-2 is 110 cfs. A maximum creek flow rate of 1,401 cfs is used for all precipitation rates that exceed 25 inches in 14 days to provide a conservative lower bound for the dilution flows during those conditions.

The ratio (FR / FD) determines an effective dilution factor for the contaminated liquid that is released during this scenario. The tabulated results show that this factor is relatively insensitive to the precipitation rate, because both the overflow volume and the creek flow are directly

proportional to the amount of precipitation. The computed ratio is slightly higher at the low end of the precipitation range, due to small nonlinearities in the empirical Buttermilk Creek flow correlation when it is extended to very low average precipitation rates. The conditional probability distribution for (FR / FD) is quantified in this analysis by parameter FRFD33.

Trench Overflow Scenario 3-3					
Trench Liquid Releases and Buttermilk Creek Dilution Flows					
14-Day Precipitation Range (inches)	Probability	Trench Overflow Volume (cu. ft.)	Trench Overflow Rate (FR, cfs)	Buttermilk Creek Flow Rate (FD, cfs)	FR / FD
1 - 3	8.40E-01	59,775	0.049	110	4.49E-04
3 - 6	1.38E-01	119,550	0.099	250	3.95E-04
6 - 9	1.72E-02	179,325	0.148	420	3.53E-04
9 - 13	4.14E-03	259,025	0.214	693	3.09E-04
13 - 15	1.81E-04	298,875	0.247	826	2.99E-04
15 - 16	1.95E-05	318,800	0.264	883	2.99E-04
16 - 18	3.25E-05	358,650	0.297	997	2.97E-04
18 - 19	5.39E-06	378,575	0.313	1,054	2.97E-04
19 - 21	7.05E-06	418,425	0.346	1,169	2.96E-04
21 - 22	1.81E-06	438,350	0.362	1,227	2.95E-04
22 - 24	1.73E-06	478,200	0.395	1,343	2.94E-04
24 - 25	5.97E-07	498,125	0.412	1,401	2.94E-04
> 25	1.23E-06	500,000	0.413	1,401	2.95E-04

Release Duration

This scenario evaluates releases that are caused by cumulative precipitation of at least 1 inch that occurs during the 14-day exposure period. Under the most limiting conditions, the releases may begin on the first day of this period and continue until the mitigation measures are fully implemented. The trench release rate analyses, Buttermilk Creek flow analyses, and dose analyses for this scenario use a 14-day duration for all releases.

8.4.3.2 Water Level at WLT / ULT Interface

Probability Weight = 0.0137

This initial condition has a probability of 1.37% that it applies at the SDA during the 30-year period of this study.

Threat Condition 1

Precipitation occurs while the geomembranes are functionally disabled due to a preceding condition, and the trench caps are intact.

The trenches will overflow if at least 9 inches of water enters them. As noted in Section 8.4.2.2, it is assumed for this analysis that 14-day precipitation totals in this range will involve contributions from at least one severe storm with precipitation rates that are sufficient to erode the trench caps and allow water intrusion into the trenches. Therefore, the Caps Intact branch in Figure 8.4-1 is bypassed for these threat conditions, despite the fact that the caps are initially intact when the scenario begins.

Under these conditions, the initiating event for Threat Condition 1 accounts for any cumulative precipitation that exceeds 9 inches in a 14-day period. The frequency of these events is quantified in this analysis by parameter IPRE9.

Scenario Frequency

The frequency of this scenario is the product of three contributors.

- Probability that trench levels are at the WLT / ULT interface (0.0137)
- Unavailability of the geomembranes, with the trench caps undisturbed (GEOMUI)
- Frequency of precipitation that exceeds 9 inches accumulation in 14 days (IPRE9)

Trench Liquid Releases and Dilution

The frequency of this scenario is determined by a total precipitation of 9 inches, or more, that occurs during the 14-day exposure period. In addition to determining the frequency of these events, the supporting meteorological data are also used to derive conditional probabilities for various precipitation rates, as shown in the table below. For example, if the total precipitation exceeds 9 inches, the data show that approximately 94% of the respective 14 consecutive day periods have cumulative precipitation of 9 to 13 inches; approximately 4% of the 14-day periods have cumulative precipitation of 13 to 15 inches; etc.

This scenario occurs during conditions when the trench levels are initially at the WLT / ULT interface. The analyses in Section 6.6.1 indicate that the first 8.7 inches of precipitation will fill the trenches. After the trenches are full, each additional inch of precipitation results in a total trench overflow liquid volume of 19,925 cubic feet. The release volumes shown below are computed for the upper bound of each precipitation range. For example, 13 inches of precipitation result in an overflow volume of $(13 - 8.7) * 19,925 = 85,678$ cubic feet. The equivalent trench overflow rate (parameter FR) is determined by dividing this release volume by the 14-day duration of the exposure period.

The flow rate in Buttermilk Creek is determined from Figure 8.4-2, using the maximum 24-hour precipitation rate for each range. For example, precipitation of 13 inches uniformly distributed over 14 days is equivalent to an average precipitation rate of approximately 0.9 inches in 24 hours. The corresponding creek flow rate from Figure 8.4-2 is 693 cfs. A maximum creek flow rate of 1,401 cfs is used for all precipitation rates that exceed 25 inches in 14 days to provide a conservative lower bound for the dilution flows during those conditions.

The ratio (FR / FD) determines an effective dilution factor for the contaminated liquid that is released during this scenario. The tabulated results show that this factor is relatively insensitive to the precipitation rate, because both the overflow volume and the creek flow are directly proportional to the amount of precipitation after the trenches are full. The conditional probability distribution for (FR / FD) is quantified in this analysis by parameter FRFD34.

Trench Overflow Scenario 3-4					
Trench Liquid Releases and Buttermilk Creek Dilution Flows					
14-Day Precipitation Range (inches)	Probability	Trench Overflow Volume (cu. ft.)	Trench Overflow Rate (FR, cfs)	Buttermilk Creek Flow Rate (FD, cfs)	FR / FD
9 - 13	9.43E-01	85,678	0.071	693	1.02E-04
13 - 15	4.12E-02	125,528	0.104	826	1.26E-04
15 - 16	4.44E-03	145,453	0.120	883	1.36E-04
16 - 18	7.41E-03	185,303	0.153	997	1.54E-04
18 - 19	1.23E-03	205,228	0.170	1,054	1.61E-04
19 - 21	1.61E-03	245,078	0.203	1,169	1.73E-04
21 - 22	4.14E-04	265,003	0.219	1,227	1.79E-04
22 - 24	3.95E-04	304,853	0.252	1,343	1.88E-04
24 - 25	1.36E-04	324,778	0.268	1,401	1.92E-04
> 25	2.79E-04	350,000	0.289	1,401	2.06E-04

Release Duration

This scenario evaluates releases that are caused by cumulative precipitation of at least 9 inches that occurs during the 14-day exposure period. Under the most limiting conditions, the releases may begin on the first day of this period and continue until the mitigation measures are fully implemented. The trench release rate analyses, Buttermilk Creek flow analyses, and dose analyses for this scenario use a 14-day duration for all releases.

Threat Condition 2

A severe windstorm or tornado damages the geomembranes. Substantial precipitation occurs during the damaging storm, and additional precipitation occurs during the period before the geomembranes are repaired or replaced.

The discussion of this threat condition in Section 8.4.3.1 explains that severe damage to the geomembranes occurs as a direct consequence from these storms, and the initial precipitation rate is high enough to erode the trench caps.

Contributing Storm Events

The high wind frequencies are quantified in Section 5.3, and the tornado frequencies are quantified in Section 5.4. The combined frequency of these storms is quantified in this analysis by parameter IWITOR.

If water levels are initially at the WLT / ULT interface, at least 9 inches of precipitation is required to completely fill the trenches. The probability distribution in Section 8.4.3.1 shows that this accumulation will be achieved immediately during 10% of the initiating storm events. For 15% of the storms, an additional accumulation of 3 inches is required to fill the trenches, and for 75% of the storms, an additional 6 inches is required.

The precipitation exceedance frequencies from Section 5.2 were used to determine the likelihood that these additional amounts of precipitation will occur during the 14-day exposure period following the initial storm. Thus, if the likelihood of accumulating an additional 3 inches within the next 14 days is represented by PREC3, and the likelihood of accumulating 6 inches is represented by PREC6, the total frequency that the windstorm occurs and at least 9 inches of precipitation accumulate during the 14-day exposure period is quantified by the following expression.

$$\text{IWITOR} * (0.10 + 0.15 * \text{PREC3} + 0.75 * \text{PREC6}) = \\ \text{IWITOR} * \text{WSPR9}$$

The first term in the parentheses (0.10) accounts for the fact that 10% of the initial storms deliver at least 9 inches of precipitation. The second term (0.15 * PREC3) accounts for the 15% of the initial storms that require at least 3 more inches of precipitation, and the likelihood that 3 inches or more occurs during the subsequent 14 days. The third term (0.75 * PREC6) accounts for the 75% of the initial storms that require 6 more inches of precipitation, and the likelihood of that accumulation. For computation convenience, the conditional accumulation term is quantified in this analysis by parameter WSPR9.

Scenario Frequency

The frequency of this scenario is the product of three contributors.

- Probability that trench levels are at the WLT / ULT interface (0.0137)
- Frequency of severe wind storms and tornadoes (IWITOR)
- Conditional likelihood that precipitation exceeds 9 inches accumulation in 14 days (WSPR9)

Trench Liquid Releases and Dilution

The frequency of this scenario is determined by 24-hour storms with additional precipitation that accumulates to at least 9 inches during the 14-day exposure period. Precipitation rates of less than 4 inches in 24 hours are not severe enough to erode the trench clay caps for any of the evaluated soil conditions. In addition to determining the frequency of these events, the supporting meteorological data are also used to derive conditional probabilities for various precipitation rates, as shown in the table below. For example, the data show that approximately 46% of these scenarios involve a 24-hour storm that produces 6 to 9 inches of precipitation, with at least 3 more inches of precipitation during the 14-day period; approximately 31% of

these scenarios involve a 24-hour storm that produces 3 to 6 inches of precipitation, with at least 6 more inches of precipitation during the 14-day period; approximately 18% of these scenarios involve a 24-hour storm that produces 9 to 12 inches of precipitation; etc.

This scenario occurs during conditions when the trench levels are initially at the WLT / ULT interface. The analyses in Section 6.6.1 indicate that the first 8.7 inches of precipitation will fill the trenches. After the trenches are full, each additional inch of precipitation results in a total trench overflow liquid volume of 19,925 cubic feet. The release volumes shown below are computed for the upper bound of each precipitation range. For example, 9 inches of precipitation result in an overflow volume of $(9 - 8.7) * 19,925 = 5,978$ cubic feet; 12 inches of precipitation result in an overflow volume of $(12 - 8.7) * 19,925 = 65,753$ cubic feet. The equivalent trench overflow rate (parameter FR) is determined by dividing the release volume by either the initial 24-hour storm period or the 14-day duration of the total exposure period, depending on when the trench is first filled.

The flow rate in Buttermilk Creek is determined from Figure 8.4-2, using the maximum 24-hour precipitation rate for each exposure period. For example, precipitation of 9 inches in 24 hours produces a creek flow rate of 6,914 cfs. Precipitation of 12 inches in 24 hours produces a creek flow rate of 9,198 cfs. Precipitation of 3 inches uniformly distributed over 14 days is equivalent to an average precipitation rate of approximately 0.2 inches in 24 hours, and the corresponding creek flow rate is 110 cfs. Precipitation of 12 inches uniformly distributed over 14 days is equivalent to an average precipitation rate of approximately 0.9 inches in 24 hours, and the corresponding creek flow rate is 620 cfs.

The ratio (FR / FD) determines an effective dilution factor for the contaminated liquid that is released during this scenario. The tabulated results show that this factor is relatively insensitive to the precipitation rate, because both the overflow volume and the creek flow are directly proportional to the amount of precipitation after the trenches are full. The computed ratio is somewhat higher at the low end of the 14-day precipitation range, due to small nonlinearities in the empirical Buttermilk Creek flow correlation when it is extended to very low average precipitation rates. The conditional probability distribution for (FR / FD) is quantified in this analysis by parameter FRFD35.

Trench Overflow Scenario 3-5					
Trench Liquid Releases and Buttermilk Creek Dilution Flows					
Precipitation Range (inches)	Probability	Trench Overflow Volume (cu. ft.)	Trench Overflow Rate (FR, cfs)	Buttermilk Creek Flow Rate (FD, cfs)	FR / FD
6 – 9 ⁽¹⁾ , + 3 ⁽²⁾	4.63E-01	5,978	0.069	6,914	1.00E-05
		59,775	0.049	110	4.49E-04
3 – 6 ⁽¹⁾ , + 6 ⁽²⁾	3.12E-01	65,753	0.054	620	8.77E-05
9 – 12 ⁽¹⁾	1.80E-01	65,753	0.761	9,198	8.27E-05
> 12 ⁽¹⁾	4.50E-02	100,000	1.157	9,198	1.26E-04

Trench Overflow Scenario 3-5 Trench Liquid Releases and Buttermilk Creek Dilution Flows					
Precipitation Range (inches)	Probability	Trench Overflow Volume (cu. ft.)	Trench Overflow Rate (FR, cfs)	Buttermilk Creek Flow Rate (FD, cfs)	FR / FD
(1) Precipitation during initial 24-hour storm					
(2) Precipitation during subsequent 14-day period					

Release Duration

This scenario evaluates releases that are initiated by damage that is caused by very severe wind storms and tornadoes with precipitation rates of more than 4 inches in 24 hours. The supporting meteorological data indicate that approximately 22% of these storms may produce enough precipitation to damage the trench caps and to overflow the trenches within the 24-hour storm period. Approximately 78% of the storms will damage the caps and partially fill the trenches. The trenches will then overflow if sufficient additional precipitation occurs during the subsequent 14-day period. The trench release rate analyses and Buttermilk Creek flow analyses for this scenario account for the actual duration of each precipitation condition (i.e., 1 day or 14 days), weighted by its respective occurrence probability. However, the dose analyses for this scenario use a 14-day duration for all releases. This simplification is somewhat conservative, because releases of 1 day, or less, account for approximately 22% of the scenario frequency.

Threat Condition 3

Precipitation occurs while the geomembranes are functionally disabled due to a preceding condition, and the trench caps are physically disrupted.

This scenario proceeds identically to that for Threat Condition 1, except that it applies for a different initial site configuration.

Scenario Frequency

The frequency of this scenario is the product of three contributors.

- Probability that trench levels are at the WLT / ULT interface (0.0137)
- Unavailability of the geomembranes, with the trench caps disturbed (GEOMUD)
- Frequency of precipitation that exceeds 9 inches accumulation in 14 days (IPRE9)

Trench Liquid Releases and Dilution

The precipitation conditions that determine the trench overflow volumes and Buttermilk Creek flow rates for this scenario are identical to those described for Threat Condition 1. The resulting conditional probability distribution for (FR / FD) is represented in this analysis by parameter FRFD36 to facilitate the scenario quantification process. The distribution is identical to that for parameter FRFD34.

Release Duration

This scenario evaluates releases that are caused by cumulative precipitation of at least 9 inches that occurs during the 14-day exposure period. Under the most limiting conditions, the releases may begin on the first day of this period and continue until the mitigation measures are fully implemented. The trench release rate analyses, Buttermilk Creek flow analyses, and dose analyses for this scenario use a 14-day duration for all releases.

8.4.3.3 Water Level at Current Conditions, or Lower

Probability Weight = 0.9851

These analyses combine the initial conditions for Current and Low levels in the trenches. These conditions have a composite probability of 98.51% that they apply at the SDA during the 30-year period of this study (93.51% for Current levels, and 5.00% for Low levels).

Threat Condition 1

Precipitation occurs while the geomembranes are functionally disabled due to a preceding condition, and the trench caps are intact.

The scenario for this threat condition is developed similarly to that described in Section 8.4.3.2 for the intermediate trench water level. The only difference is that a total accumulation of at least 25 inches is required to fill the trenches.

Scenario Frequency

The frequency of this scenario is the product of three contributors.

- Probability that trench levels are at the current levels, or lower (0.9851)
- Unavailability of the geomembranes, with the trench caps undisturbed (GEOMUI)
- Frequency of precipitation that exceeds 25 inches accumulation in 14 days (IPRE25)

Trench Liquid Releases and Dilution

The frequency of this scenario is determined by a total precipitation of 25 inches, or more, that occurs during the 14-day exposure period. The supporting meteorological data show that this amount of precipitation has never occurred during any 14 consecutive day period in the regional weather records. Therefore, it is very difficult to estimate conditional probabilities for various precipitation ranges in excess of this total. The analyses of this scenario are simplified by assuming a nominal total precipitation of 30 inches during the 14-day exposure period.

This scenario occurs during conditions when the trench levels are initially at their 2008 benchmark values. The analyses in Section 6.6.1 indicate that the first 24.7 inches of precipitation will fill the trenches. After the trenches are full, each additional inch of precipitation results in a total trench overflow liquid volume of 19,925 cubic feet. The release volume shown below is computed for the applied 30-inch precipitation, which results in an overflow volume of $(30 - 24.7) * 19,925 = 105,603$ cubic feet. The equivalent trench overflow rate (parameter FR) is determined by dividing this release volume by the 14-day duration of the exposure period.

The flow rate in Buttermilk Creek is determined from Figure 8.4-2, using the 30-inch precipitation rate. For example, precipitation of 30 inches uniformly distributed over 14 days is equivalent to an average precipitation rate of approximately 2.1 inches in 24 hours. The corresponding creek flow rate from Figure 8.4-2 is 1,688 cfs.

The ratio (FR / FD) determines an effective dilution factor for the contaminated liquid that is released during this scenario. The results show that this factor is slightly lower than that computed for other release scenarios. This is due to the fact that the trench overflow volume is relatively small after the trenches are filled, but the large amount of precipitation produces very high creek flows. The conditional probability distribution for (FR / FD) is quantified in this analysis by parameter FRFD37.

Trench Overflow Scenario 3-7					
Trench Liquid Releases and Buttermilk Creek Dilution Flows					
14-Day Precipitation Range (inches)	Probability	Trench Overflow Volume (cu. ft.)	Trench Overflow Rate (FR, cfs)	Buttermilk Creek Flow Rate (FD, cfs)	FR / FD
> 25	1.00E+00	105,603	0.087	1,688	5.17E-05

Release Duration

This scenario evaluates releases that are caused by cumulative precipitation of at least 25 inches that occurs during the 14-day exposure period. In principle, the trenches could hypothetically fill on the first day of this period, and the releases could then continue for the subsequent 14 days. However, considering the extremely large amounts of required precipitation, it is most likely that these releases will not begin until almost the end of the 14-day period, with a correspondingly shorter release duration until the mitigation measures are fully implemented. Due to the very sparse supporting meteorological data, the QRA team did not attempt to estimate the mean duration of these releases. The trench release rate analyses, Buttermilk Creek flow analyses, and dose analyses for this scenario use a 14-day duration for all releases. This simplification is extremely conservative for the dose analyses, because it is very likely that the releases will occur only during one or two days at the end of the analysis period.

Threat Condition 2

A severe windstorm or tornado damages the geomembranes. Substantial precipitation occurs during the damaging storm, and additional precipitation occurs during the period before the geomembranes are repaired or replaced.

The scenario for this threat condition is developed similarly to that described in Section 8.4.3.2 for the intermediate trench water level. The only difference is that a total accumulation of at least 25 inches is required to fill the trenches.

Contributing Storm Events

The high wind frequencies are quantified in Section 5.3, and the tornado frequencies are quantified in Section 5.4. The combined frequency of these storms is quantified in this analysis by parameter IWITOR.

If water levels are initially at the WLT / ULT interface, at least 25 inches of precipitation is required to completely fill the trenches. The probability distribution in Section 8.4.3.1 shows that this accumulation will be partially achieved during the initial storm event. For 2% of the storms, an additional 13 inches of precipitation is required to fill the trenches. For 8% of the storms, an additional 16 inches is required; for 15% of the storms, an additional 19 inches is required; and for 75% of the storms, an additional 22 inches is required.

The same process described in Section 8.4.3.2 was used to quantify the likelihood that each additional accumulation occurs during the 14 days after the initial storm. The total frequency that the windstorm occurs and at least 25 inches of precipitation accumulate during the 14-day exposure period is quantified by the following expression.

$$\text{IWITOR} * (0.02 * \text{PREC13} + 0.08 * \text{PREC16} + 0.15 * \text{PREC19} + 0.75 * \text{PREC22}) = \\ \text{IWITOR} * \text{WSPR25}$$

The first term in the parentheses (0.02 * PREC13) accounts for the 2% of the initial storms that require at least 13 more inches of precipitation, and the likelihood that 13 inches or more occurs during the subsequent 14 days, and so forth. For computation convenience, the conditional accumulation term is quantified in this analysis by parameter WSPR25.

Scenario Frequency

The frequency of this scenario is the product of three contributors.

- Probability that trench levels are at the current levels, or lower (0.9851)
- Frequency of severe windstorms and tornadoes (IWITOR)
- Conditional likelihood that precipitation exceeds 25 inches accumulation in 14 days (WSPR25)

Trench Liquid Releases and Dilution

The frequency of this scenario is determined by 24-hour storms with additional precipitation that accumulates to at least 25 inches during the 14-day exposure period. Precipitation rates of less than 4 inches in 24 hours are not severe enough to erode the trench clay caps for any of the evaluated soil conditions.

The supporting meteorological data show that this total amount of precipitation has never occurred during any 14 consecutive day period in the regional weather records. Therefore, it is very difficult to estimate conditional probabilities for various precipitation ranges in excess of this total. The supporting meteorological data are used to derive conditional probabilities for various intermediate precipitation rates, as shown in the table below. For example, the data show that approximately 37% of these scenarios involve a 24-hour storm that produces more than 12 inches of precipitation, with at least 13 additional inches of precipitation during the 14-

day period; approximately 30% of these scenarios involve a 24-hour storm that produces 9 to 12 inches of precipitation, with at least 16 more inches of precipitation during the 14-day period; etc. The analyses of this scenario are simplified by assuming a nominal total precipitation of 30 inches during the 14-day exposure period.

This scenario occurs during conditions when the trench levels are initially at their 2008 benchmark values. The analyses in Section 6.6.1 indicate that the first 24.7 inches of precipitation will fill the trenches. After the trenches are full, each additional inch of precipitation results in a total trench overflow liquid volume of 19,925 cubic feet. The release volumes shown below are computed for the applied 30-inch precipitation, which results in an overflow volume of $(30 - 24.7) * 19,925 = 105,603$ cubic feet. The equivalent trench overflow rate (parameter FR) is determined by dividing this release volume by the 14-day duration of the exposure period.

The flow rate in Buttermilk Creek is determined from Figure 8.4-2, using the 30-inch precipitation rate. For example, precipitation of 30 inches uniformly distributed over 14 days is equivalent to an average precipitation rate of approximately 2.1 inches in 24 hours. The corresponding creek flow rate from Figure 8.4-2 is 1,688 cfs.

The ratio (FR / FD) determines an effective dilution factor for the contaminated liquid that is released during this scenario. The results show that this factor is slightly lower than that computed for other release scenarios. This is due to the fact that the trench overflow volume is relatively small after the trenches are filled, but the large amount of precipitation produces very high creek flows. The conditional probability distribution for (FR / FD) is quantified in this analysis by parameter FRFD38.

Trench Overflow Scenario 3-8					
Trench Liquid Releases and Buttermilk Creek Dilution Flows					
Precipitation Range (inches)	Probability	Trench Overflow Volume (cu. ft.)	Trench Overflow Rate (FR, cfs)	Buttermilk Creek Flow Rate (FD, cfs)	FR / FD
> 12 ⁽¹⁾ , + 13 ⁽²⁾	3.69E-01	105,603	0.087	1,688	5.17E-05
9 - 12 ⁽¹⁾ , +16 ⁽²⁾	2.97E-01	105,603	0.087	1,688	5.17E-05
3 - 6 ⁽¹⁾ , + 22 ⁽²⁾	1.97E-01	105,603	0.087	1,688	5.17E-05
6 - 9 ⁽¹⁾ , + 19 ⁽²⁾	1.37E-01	105,603	0.087	1,688	5.17E-05
(1) Precipitation during initial 24-hour storm (2) Precipitation during subsequent 14-day period					

Release Duration

This scenario evaluates releases that are initiated by damage that is caused by very severe wind storms and tornadoes with precipitation rates of more than 4 inches in 24 hours. The trenches will then overflow if the cumulative precipitation exceeds 25 inches during the subsequent 14-day period. In principle, the initial storm could hypothetically fill the trenches on

the first day of this period, and the releases could then continue for the subsequent 14 days. However, considering the extremely large amounts of required precipitation, it is most likely that these releases will not begin until some time during the 14-day period, with a correspondingly shorter release duration until the mitigation measures are fully implemented. Due to the very sparse supporting meteorological data, the QRA team did not attempt to estimate the mean duration of these releases. The trench release rate analyses, Buttermilk Creek flow analyses, and dose analyses for this scenario use a 14-day duration for all releases. This simplification is very conservative for the dose analyses, because it is likely that the releases will not start until several days after the initial storm.

Threat Condition 3

Precipitation occurs while the geomembranes are functionally disabled due to a preceding condition, and the trench caps are physically disrupted.

This scenario proceeds identically to that for Threat Condition 1, except that it applies for a different initial site configuration.

Scenario Frequency

The frequency of this scenario is the product of three contributors.

- Probability that trench levels are at the current levels, or lower (0.9851)
- Unavailability of the geomembranes, with the trench caps disturbed (GEOMUD)
- Frequency of precipitation that exceeds 25 inches accumulation in 14 days (IPRE25)

Trench Liquid Releases and Dilution

The precipitation conditions that determine the trench overflow volume and Buttermilk Creek flow rate for this scenario are identical to those described for Threat Condition 1. The resulting conditional probability distribution for (FR / FD) is represented in this analysis by parameter FRFD39 to facilitate the scenario quantification process. The distribution is identical to that for parameter FRFD37.

Release Duration

As discussed for Threat Condition 1, the trench release rate analyses, Buttermilk Creek flow analyses, and dose analyses for this scenario use a 14-day duration for all releases.

8.4.4 General Characteristics of Releases

Table 8.4-1 summarizes the nine scenarios that contribute to the frequency of Release Mechanism 3, as described in the preceding section.

This release mechanism involves overflow of all waste trenches and releases of radioactive liquids via surface runoff. The specific releases are characterized more completely in Section 9.

Table 8.4-1. Scenarios for Release Mechanism 3					
Initial Trench Water Level	Threat Condition – Damage Scenario	Scenario Frequency (event / year)	Trench Liquid Release / Dilution (FR / FD)	Release Duration (T, days)	
High	Geomembranes unavailable; Trench caps intact; Severe precipitation erodes caps	0.0012 * GEOMUI * IPRECF	FRFD31	2	
	Geomembranes in place; Trench caps intact; Severe storm destroys geomembranes and erodes caps	0.0012 * IWITOR	FRFD32	1	
	Geomembranes unavailable; Trench caps disrupted; Precipitation \geq 1 inch in 14 days	0.0012 * GEOMUD * IPRE1	FRFD33	14	
WLT / ULT Interface	Geomembranes unavailable; Trench caps intact; Precipitation \geq 9 inches in 14 days (assumed to erode caps)	0.0137 * GEOMUI * IPRE9	FRFD34	14	
	Geomembranes in place; Trench caps intact; Severe storm destroys geomembranes and erodes caps; Precipitation \geq 9 inches total accumulation in 14 days	0.0137 * IWITOR * WSPR9	FRFD35	14	
	Geomembranes unavailable; Trench caps disrupted; Precipitation \geq 9 inches in 14 days	0.0137 * GEOMUD * IPRE9	FRFD36	14	
Current or Lower	Geomembranes unavailable; Trench caps intact; Precipitation \geq 25 inches in 14 days (assumed to erode caps)	0.9851 * GEOMUI * IPRE25	FRFD37	14	
	Geomembranes in place; Trench caps intact; Severe storm destroys geomembranes and erodes caps; Precipitation \geq 25 inches total accumulation in 14 days	0.9851 * IWITOR * WSPR25	FRFD38	14	
	Geomembranes unavailable; Trench caps disrupted; Precipitation \geq 25 inches in 14 days	0.9851 * GEOMUD * IPRE25	FRFD39	14	

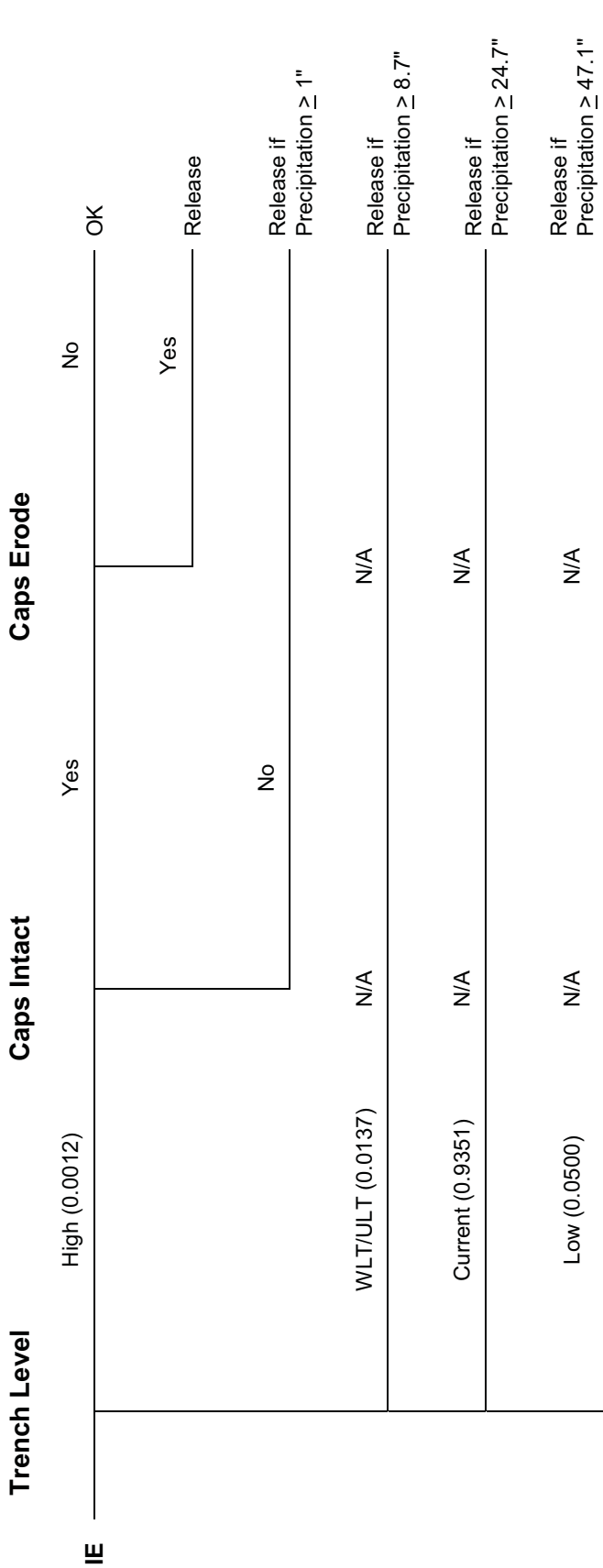

Figure 8.4-1. Release Mechanism 3 Scenario Logic

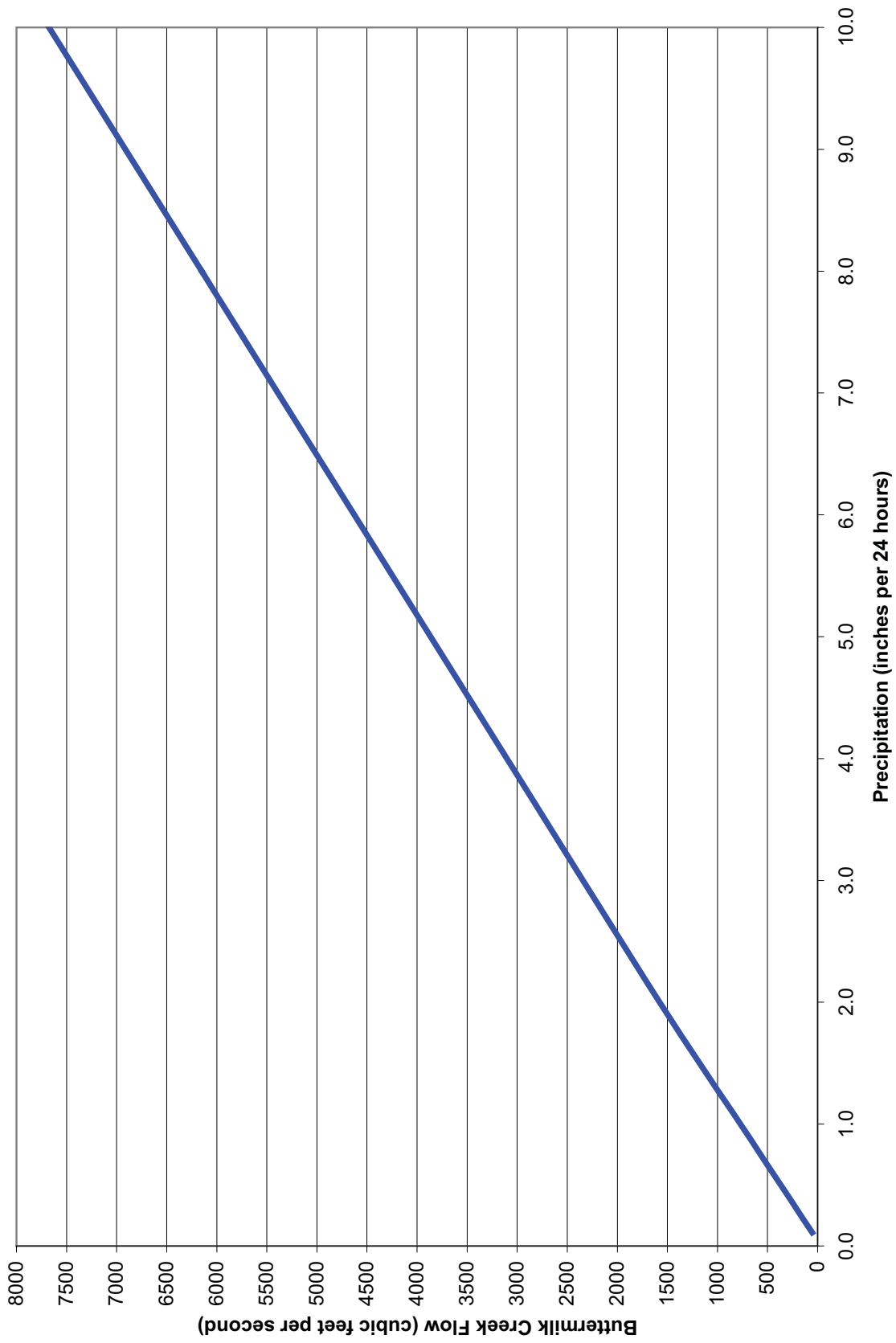

Figure 8.4-2. Buttermilk Creek Flow Correlation

8.5 RELEASE MECHANISM 4

Release Mechanism 4 involves physical breaches of the waste trenches and releases of liquid and solid radioactive materials.

8.5.1 Threat Conditions

The scenarios for Release Mechanism 4 are initiated by disruptive events and natural processes that destabilize the slopes on the North end of the site, adjacent to Erdman Brook, and at the East side of the site, along Frank's Creek. Releases occur if the slope damage extends far enough into the SDA site area to physically breach the trench walls and mobilize the waste materials.

Three general threat conditions contribute to these release scenarios.

- (1) An earthquake destabilizes the slopes and causes sections to fail.
- (2) A landslide occurs due to causes other than seismic events or erosion.
- (3) Precipitation causes extensive erosion of existing gullies in the slopes.

8.5.2 Analysis Framework

A detailed logic model is not needed to evaluate possible conditions that may affect the progression of these scenarios, or to support their quantification. The frequencies and consequences of these release scenarios are based on the seismic analyses in Section 6.2, the landslide analyses in Section 6.3, and the erosion analyses in Section 6.4.

The scenarios are also based on the following information, assumptions, and supporting analyses.

8.5.2.1 Trench Levels

The amount of liquid released during these scenarios depends on the water levels in the trenches when the slope failure occurs. Four potential trench water levels are used throughout the study. The probabilities that each water level applies at the SDA site during the 30-year study period were derived from the analyses that are documented in Section 6.7. The four water levels are:

- **High:** Level is between the WLT / ULT interface and the top of the trenches. This condition is conservatively bounded by assuming that levels are at the tops of the trenches. This condition is assigned a probability of 0.12% (i.e., 12/100 of 1%).
- **WLT / ULT:** Level is between the current leachate level and the WLT / ULT interface. This condition is conservatively bounded by assuming that levels are at the WLT / ULT interface. This condition is assigned a probability of 1.37%.
- **Current:** Level is at the current leachate level. This condition is assigned a probability of 93.51%.

- **Low:** Level is below the current leachate level and is effectively at the bottom of the trenches. This condition is assigned a probability of 5.00%.

These analyses combine the initial conditions for Current and Low levels in the trenches. These conditions are assigned a composite probability of 98.51% that they apply at the SDA during the 30-year period of this study (93.51% for Current levels, and 5.00% for Low levels). Current leachate levels are used for these conditions. Thus, the liquid release scenarios account for three initial trench water levels: High, WLT / ULT, and Current / Low.

8.5.2.2 Liquid Release Durations

Sections 7.1.3 and 7.1.4 summarize the NYSERDA team's evaluations of intervention and mitigation responses after slope failures that are caused by seismic events and severe rapid erosion. The evaluated scenarios focus primarily on failures of the North slope, adjacent to Erdman Brook. These scenarios were evaluated by the NYSERDA team at an intermediate stage of the project, when preliminary results were available for only the North slope stability analyses. Several scenarios for this release mechanism involve disruptive failures of both the North and East slopes, with damage that is significantly more widespread than that assessed by the NYSERDA team. It is very likely that additional time would be required to fully mitigate this extensive damage.

The NYSERDA evaluations focus primarily on efforts to stabilize the slopes and prevent further subsidence, erosion, and transport of exposed waste materials into the streams. If the trenches are breached, it is very likely that the confined liquid leachate will flow out of the trenches and enter the streams well before the mitigation teams are able to install effective containment or diversion barriers. Therefore, this analysis includes credit for NYSERDA mitigation to prevent further mobilization of solid wastes after the initial release, but it does not include credit for mitigation efforts to prevent or divert releases of the liquid leachate inventory.

No detailed analyses were performed to evaluate the amount of time during which leachate from the breached trenches will drain into the adjacent streams. Two nominal durations are used for the analyses of liquid releases during these scenarios.

- For scenarios that affect up to two rows of trenches, it is assumed that the leachate will drain completely within 48 hours after the initial breach.
- For extremely severe scenarios that affect the entire site, it is assumed that the leachate will drain completely within 24 hours after the initial breach.

These durations are judged to provide conservative bounds for the integrated release rates that would occur during a particular breach scenario, with an initial release of fluid that accompanies the trench wastes and soils, followed by more gradual releases of the remaining liquid through the new slope geometry and debris field.

8.5.3 Analyzed Scenarios

A total of 20 scenarios are analyzed for these releases. The scenarios account for five specific threat conditions, three possible initial trench water levels that affect liquid releases for each

condition, and a release of trench waste solids for each condition. Eight scenarios are initiated by seismic events, eight scenarios are caused by landslides, and four scenarios involve severe gully erosion. The following items describe each scenario and document specific elements of its analysis.

8.5.3.1 Seismic-Induced Slope Failures

The frequency of seismic-induced slope failures that are severe enough to breach the waste trenches is quantified by combining the frequencies of earthquakes of varying magnitudes with the conditional likelihoods (fragilities) of slope failures at each magnitude. The earthquake frequency quantifies: "How often does an earthquake of magnitude X occur?" The slope fragility quantifies: "How likely is it that the slope will fail, if an earthquake of magnitude X occurs?"

Slope Failure Fragilities

Section 6.2 documents analyses that were performed to evaluate the stability of the North and East slopes for a broad range of applied seismic accelerations. Table 6.2-7 summarizes the results from those analyses in the form of fragilities that apply to two levels of seismic damage.

- **Damage Condition 1:** Slope failures intersect Trenches 1/2, Trench 8, and 125 feet of the north ends of Trenches 3, 4, and 5
- **Damage Condition 2:** Slope failures intersect Trenches 1/2, Trench 3, Trench 8, Trench 9, and 250 feet of the north ends of Trenches 4 and 5

Damage Condition 1 accounts for failures of the East slope that intersect the first row of trenches at the east side of the site (i.e., Trenches 1/2 and 8), but do not extend as far as Trenches 3 and 9. These events also affect a portion of the North slope that intersects the north ends of Trenches 3, 4, and 5.

Damage Condition 2 accounts for more extensive failures of the East slope that intersect the first two rows of trenches (i.e., Trenches 1/2, 3, 8, and 9). These events also affect a larger portion of the North slope that intersects the north ends of Trenches 4 and 5.

The fragility values in Table 6.2-7 quantify the conditional likelihood for each level of slope damage, as a function of the applied seismic acceleration. For example, if an earthquake occurs with peak ground acceleration of 0.25 g to 0.35 g, there is a probability of 1.25% that 7% of these events will cause slope failures that result in Damage Condition 1. There is also a probability of 1.25% that 2% of these events will cause slope failures that result in Damage Condition 2.

Seismic Event Frequencies

Section 5.5 documents the seismic hazard curves that were developed for this study. Table 5.5-3 and Figure 5.5-4 show the exceedance frequencies for peak ground accelerations over a range from 0.01 g to 2.0 g. According to the fragility analyses, the likelihood of damaging slope failures is insignificant for accelerations below approximately 0.25 g. The extent of slope damage does not increase appreciably for accelerations above approximately 1.0 g. Therefore,

the seismic hazard was divided into the following five discrete acceleration ranges. The occurrence frequency for each range was quantified by evaluating the exceedance frequency for the lower bound of the range (e.g., the frequency of accelerations greater than, or equal to, lower bound X) and subtracting the exceedance frequency for the upper bound of the range (e.g., the frequency of accelerations greater than, or equal to, upper bound Y).

Acceleration Range (g)	Seismic Event Frequency (event / year)				
	5th Percentile	Median	Mean	95th Percentile	Error Factor
0.25 – 0.35	3.07E-06	1.84E-05	3.33E-05	1.10E-04	6.0
0.35 – 0.50	1.80E-06	1.17E-05	2.23E-05	7.59E-05	6.5
0.50 – 0.70	7.10E-07	4.97E-06	1.00E-05	3.48E-05	7.0
0.70 – 1.0	3.43E-07	2.57E-06	5.44E-06	1.93E-05	7.5
> 1.0	2.44E-07	1.95E-06	4.34E-06	1.56E-05	8.0

Seismic Damage Frequencies

The frequency distribution for each seismic acceleration range was multiplied by the fragility distribution for each level of slope damage that applies for that range of accelerations, and the results were summed over all accelerations from 0.25 g to 1.0 g. (This process is numerically equivalent to a discrete convolution of the seismic hazard curves in Figure 5.5-4 with the slope fragility results in Table 6.2-7.) The results from that process are summarized below.

Seismic-Induced Slope Damage Condition	Damage Frequency (event / year)				
	5th Percentile	Median	Mean	95th Percentile	Error Factor
1	1.76E-07	1.02E-06	1.74E-06	5.49E-06	5.6
2	1.29E-07	5.94E-07	8.78E-07	2.52E-06	4.4

Seismic Damage Scenarios

Each slope damage condition corresponds to four separate scenarios for releases from the waste trenches. Three scenarios account for releases of the liquid leachate, depending on the initial water level in the trenches. One scenario accounts for the solid waste material that is deposited in the adjacent streams.

The scenarios for Damage Condition 1 result in releases from Trenches 1/2, Trench 8, and 125 feet of the north ends of Trenches 3, 4, and 5. The frequencies of these scenarios are quantified in this analysis by parameter SSL0D1. Each liquid release scenario also accounts for the respective trench water level that may exist when the earthquake occurs.

The scenarios for Damage Condition 2 result in releases from Trenches 1/2, Trench 3, Trench 8, Trench 9, and 250 feet of the north ends of Trenches 4 and 5. The frequencies of these scenarios are quantified in this analysis by parameter SSLOD2. Each liquid release scenario also accounts for the respective trench water level that may exist when the earthquake occurs.

8.5.3.2 Landslides

Section 6.3 describes the analyses of two levels of landslide damage that may affect the SDA. These landslides result from the evolution of natural processes that may destabilize the slopes adjoining Erdman Brook, Frank's Creek, or Buttermilk Creek at some time during the 30-year period of this study. The analyses explicitly exclude the impacts from seismic events and rapid erosion, which are evaluated separately as contributors to other slope failure scenarios.

- **Localized Landslide:** These failures involve the slopes along Erdman Brook and Frank's Creek. The extent of damage may intersect Trenches 1/2, Trench 8, and the north ends of Trenches 3, 4, and 5.
- **Regionally Disruptive Landslide:** This extensive failure involves a large section of the Buttermilk Creek drainage basin adjacent to the SDA site. The extent of damage affects the entire site.

Each landslide corresponds to four separate scenarios for releases from the waste trenches. Three scenarios account for releases of the liquid leachate, depending on the initial water level in the trenches. One scenario accounts for the solid waste material that is deposited in the adjacent streams.

The Localized Landslide scenarios result in releases from Trenches 1/2, Trench 8, and portions of the north ends of Trenches 3, 4, and 5. The analyses of these scenarios are simplified by assuming that the North slope damage extends up to 125 feet into Trenches 3, 4, and 5. This assigned damage is very conservative, considering the lower North slope vulnerability to these failures. However, it allows the risk impacts from these scenarios to be combined with seismic Damage Condition 1 for the purposes of characterizing the trench releases. The frequencies of these scenarios are quantified in this analysis by parameter LOCALS. Each liquid release scenario also accounts for the respective trench water level that may exist when the landslide occurs.

The Regionally Disruptive Landslide scenarios result in releases from all of the SDA trenches. The frequencies of these scenarios are quantified in this analysis by parameter GLOBLS. Each liquid release scenario also accounts for the respective trench water level that may exist when the landslide occurs.

8.5.3.3 Slope Gully Erosion

Rapid erosion of gullies in the slopes along Erdman Brook and Frank's Creek to the extent that gully headcuts may breach the waste trenches can occur only if the geomembranes are not in place and the engineered drainage control systems are not functioning. The frequency of gully erosion that is severe enough to breach the waste trenches is quantified by combining the frequencies of intense precipitation events with the conditional likelihoods (fragilities) of gully migration for each precipitation intensity. The precipitation frequency quantifies: "How often

does precipitation of intensity X occur?" The gully migration fragility quantifies: "How likely is it that gullies will breach the trenches, if precipitation of intensity X occurs?"

Geomembrane Unavailability

These scenarios can occur only if the geomembranes are not intact, and a large portion of the SDA site surface is exposed. Section 7.2 evaluates several potential causes for this condition. Severe precipitation and gully erosion may occur while the geomembranes are unavailable after any of these causes. Therefore, all causes for geomembrane unavailability are combined and are quantified in this analysis by parameter GEOMUA.

Gully Erosion Fragilities

Section 6.4.4.2 documents analyses that were performed to evaluate gully head migration distances as a function of precipitation intensity under conditions when the geomembranes are not intact. Table 6.4-6 and Figure 6.4-9 summarize the results from those analyses in the form of fragilities that evaluate the conditional probability of trench intersection for each precipitation rate. Gully intersection with the waste trenches occurs only for the "high estimate" parametric conditions (highest erodibility) and only for precipitation totals above approximately 16 inches in 24 hours. The analyses show that Gully 1 (located on the East slope, near the northeast corner of the site) is the predominant contributor to this damage.

A probabilistic weight of 75% was assigned that the "best estimate" parametric conditions in the fragility analyses may apply to actual conditions at the SDA site during the 30-year period of this study. Equal weights of 12.5% each were assigned that the "high" and "low" estimates may apply.

The fragility values in Table 6.4-6 quantify the conditional likelihood for gully intersection with the trenches, as a function of the precipitation intensity. For example, if a total rainfall of 17 inches occurs during 24 hours, there is a probability of 12.5% ("high estimate") that 2.5% of these events will cause sufficient erosion of Gully 1 to breach Trenches 1/2.

Precipitation Frequencies

The analyses in Section 6.4 were performed for 24-hour precipitation events. Five nominal storm durations (2, 4, 6, 8, and 10 hours) were used to derive rainfall intensities during these events. Section 5.2 summarizes the historical precipitation data for the region surrounding the West Valley site. Precipitation exceedance frequencies are derived for 24-hour, 48-hour, 3-day, 7-day, and 14-day exposure periods.

The historical experience shows that the largest multi-day cumulative precipitation totals almost always involve severe single-day storms. In other words, the largest 3-day, 7-day, and 14-day cumulative precipitation periods typically include a severe 1-day storm, preceded or followed by days with much lower accumulations. Thus, intense precipitation events that may cause extensive gully migration are determined almost entirely by single-day storms. Periods of moderate to strong precipitation that continue for several consecutive days are not evident in the regional weather records. (Multi-day snowstorms do occur in the region. Although these storms may result in significant snow accumulations, they do not contribute directly to rapid gully erosion.)

Reviews of the historical data and examinations of the precipitation exceedance frequencies indicate that 48-hour storm periods may also contribute to significant gully erosion. The precipitation totals for some 48-hour periods include significant contributions from consecutive days, indicating that longer duration storms may persist for several hours, or short duration storms may span the daily reporting intervals. To account for these storms, it was assumed that the fragility results in Table 6.4-6 and Figure 6.4-9 apply to both 24-hour and 48-hour precipitation periods. This assumption introduces some amount of numerical conservatism, because it is likely that some of the 48-hour precipitation totals result from less intense storms. However, it was not practical to refine the historical data analyses or the exceedance frequencies to more precisely account for individual storms. The data and the exceedance analyses confirm that the largest precipitation totals for 3-day, 7-day, and 14-day exposure periods are determined entirely by 24-hour or 48-hour storms. Therefore, extension of the gully erosion analyses beyond a 48-hour period is not warranted.

Gully Erosion Damage Frequency

The 24-hour and 48-hour precipitation exceedance frequencies from Section 5.2 were convolved with the weighted slope gully fragility results from Figure 6.4-9 to derive the frequency at which gully erosion will breach the nearest waste trench. The following table summarizes the results from that calculation.

Frequency of Slope Gully Intrusion that Breaches a Trench, 24-Hour and 48-Hour Precipitation Events, Geomembranes Not Intact and Drainage Systems Not Functioning (event / year)				
5th Percentile	Median	Mean	95th Percentile	Error Factor
5.34E-10	6.16E-07	3.76E-06	1.34E-05	158

There is very large uncertainty in this frequency. The lower bounds of the uncertainty distribution are derived consistently from the convolved frequency and fragility curves. However, they are influenced strongly by the fact that trench intersections do not occur for most site soil conditions, even at very high precipitation rates. Therefore, substantial probability is assigned that the frequency of these events is nearly zero. This results in a very skewed uncertainty distribution, with the corresponding parametric values for the 5th probability percentile and the computed error factor.

This damage is caused by precipitation totals that exceed 16 inches during a 24-hour or 48-hour storm period. There are approximately equal contributions from 1-day storms and 2-day storms.

Gully Erosion Damage Scenarios

Four scenarios are analyzed for these releases. Three scenarios account for releases of the liquid leachate, depending on the initial water level in the trenches. One scenario accounts for the solid waste material that is deposited in the adjacent streams.

The gully erosion analyses conclude that only Gully 1 may breach Trenches 1/2 for precipitation rates up to 25 inches in 24 hours. No other gully heads intersect any trenches. The functional impacts from this gully erosion damage are evaluated as follows in the SDA risk assessment models.

- It is likely that the gully erosion will destabilize other sections of the East slope, causing localized collapse or landslides. This damage is assumed to intersect Trench 8, in addition to the direct gully breach of Trenches 1/2.
- It is also likely that the gully erosion will destabilize portions of the North slope. Potential landslides in the northern section of the East slope will affect at least the northeast corner of the trench area, and may extend some distance along Erdman Brook. This damage is also assumed to intersect the north ends of Trenches 3, 4, and 5.

Thus, the combined damage from these scenarios is assumed to intersect Trenches 1/2, Trench 8, and the north ends of Trenches 3, 4, and 5. The damaging gully erosion frequency is quantified in this analysis by parameter GULLER. As noted previously, this extensive gully erosion can occur only during conditions when the geomembrane covers are removed and the engineered drainage control systems are not functioning normally.

The total frequency of each scenario is the product of three contributors.

- Unavailability of the geomembranes (GEOMUA)
- Frequency of gully erosion that breaches the waste trenches (GULLER)
- Trench water level probability when the erosion damage occurs (for liquid release scenarios)

8.5.4 General Characteristics of Releases

Table 8.5-1 summarizes the 20 scenarios that contribute to the frequency of Release Mechanism 4, as described in the preceding section.

This release mechanism involves physical breaches of the waste trenches and releases of liquid and solid radioactive materials. Four different release conditions are identified to account for the amount of waste material affected and potential impacts on its distribution after release.

- **Release Condition 4 – 1:** This release involves the material in Trenches 1/2, Trench 8, and 125 feet of the north ends of Trenches 3, 4, and 5. These releases are caused by seismic-induced slope failures and localized landslides that are not directly correlated to precipitation events.
- **Release Condition 4 – 2:** This release involves the material in Trenches 1/2, Trench 8, and 125 feet of the north ends of Trenches 3, 4, and 5. These releases are caused by gully erosion. They occur as a direct consequence of precipitation that exceeds 16 inches during a 24-hour or 48-hour severe storm event.
- **Release Condition 4 – 3:** This release involves the material in Trenches 1/2, Trench 3, Trench 8, Trench 9, and 250 feet of the north ends of Trenches 4 and 5. These releases

are caused by seismic-induced slope failures that are not directly correlated to precipitation events.

- **Release Condition 4 – 4:** This release involves the material in all trenches. These releases are caused by regionally disruptive "global" landslides that are not directly correlated to precipitation events.

The specific releases are characterized more completely in Section 9.

Table 8.5-1. Scenarios for Release Mechanism 4 (Page 1 of 2)				
Release Condition	Threat – Damage Scenario	Scenario Quantification		
		Initial Trench Water Level	Frequency (event / year)	Release Duration (days)
4 – 1	Seismic event; Slope failure damage 1; Liquid releases	a High	0.0012 * SSL0D1	2
		b WLT / ULT	0.0137 * SSL0D1	2
		c Current / Low	0.9851 * SSL0D1	2
4 – 1	Seismic event; Slope failure damage 1; Solids releases	--	SSL0D1	--
		a High	0.0012 * LOCALS	2
		b WLT / ULT	0.0137 * LOCALS	2
4 – 2	Localized landslide; Liquid releases	c Current / Low	0.9851 * LOCALS	2
		--	LOCALS	--
		a High	0.0012 * GEOMUA * GULLER	2
4 – 2	Geomembranes unavailable; Gully erosion; Liquid releases	b WLT / ULT	0.0137 * GEOMUA * GULLER	2
		c Current / Low	0.9851 * GEOMUA * GULLER	2
		--	GEOMUA * GULLER	--
4 – 3	Seismic event; Slope failure damage 2; Liquid releases	a High	0.0012 * SSL0D2	2
		b WLT / ULT	0.0137 * SSL0D2	2
		c Current / Low	0.9851 * SSL0D2	2
4 – 3	Seismic event; Slope failure damage 2; Solids releases	--	SSL0D2	--

Table 8.5-1. Scenarios for Release Mechanism 4 (Page 2 of 2)

Release Condition	Threat – Damage Scenario	Scenario Quantification		
		Initial Trench Water Level	Frequency (event / year)	Release Duration (days)
4 – 4	Regional landslide; Liquid releases	a High	0.0012 * GLOBLS	1
		b WLT / ULT	0.0137 * GLOBLS	1
		c Current / Low	0.9851 * GLOBLS	1
	Regional landslide; Solids releases	--	GLOBLS	--

8.6 RELEASE MECHANISM 5

Release Mechanism 5 involves extensive physical disruption of the SDA site and airborne releases from the waste trenches.

This release mechanism accounts for disruptive events that cause an immediate release of airborne activity from the trenches. These events also cause substantial damage to the geomembrane covers, and they physically disturb the site surface. Release Mechanism 3 accounts for subsequent releases that may be caused by precipitation that occurs before the site is restored to its normal configuration.

8.6.1 Threat Conditions

All scenarios for Release Mechanism 5 are initiated by high energy impacts on the SDA. The following threats contribute to these scenarios.

- Commercial aircraft crash
- Military aircraft crash
- Meteorite impact

General aviation aircraft crashes may result in fires that cause extensive damage to the geomembranes. However, the aircraft mass and impact energy are typically not sufficient to penetrate very deeply into the compacted clay soil. Therefore, the analyses in Section 7.2 include these events as contributors to geomembrane damage, but they are not a threat for direct releases via Release Mechanism 5.

Seismic events may damage the geomembranes and disrupt the SDA surface. The analyses in Section 7.2 include these events as contributors to geomembrane damage. Release Mechanism 4 accounts for the impacts from seismic events that physically relocate portions of the trenches that border the slopes at the North and East sides of the site. The analyses did not identify any other seismic-induced failures that may cause only airborne releases from the trenches. Therefore, seismic events are not a threat for Release Mechanism 5.

8.6.2 Analysis Framework

A detailed logic model is not needed to evaluate possible conditions that may affect the progression of these scenarios, or to support their quantification.

It is assumed that the physical damage from any of these threats will penetrate far enough below the SDA surface to cause a release of airborne activity from the waste materials. The aircraft crashes will disrupt a large area of the site. The meteorite impact frequency accounts for objects with effective diameters as small as approximately 0.3 meter. However, the consequences from these and larger objects are bounded by assuming that they cause substantial damage to the site. Therefore, it is conservatively assumed that releases will occur from all of the trenches.

8.6.3 Analyzed Scenarios

One scenario is analyzed for these releases. That scenario includes the combined contributions from all three threats.

Section 5.6 evaluates the frequencies of commercial and military aircraft crashes that impact the SDA site. The respective frequencies are quantified in this analysis by parameters COMMAC and MILIAC.

Section 5.7 evaluates the frequency of meteorite impacts at the SDA site. The impact frequencies for objects with effective diameters larger than 1 meter are numerically insignificant. Therefore, the meteorite impact frequency for this analysis accounts for objects with diameters of approximately 0.3 meter, and larger. As noted in Section 8.6.2, the consequences from these impacts are bounded by assuming that they cause extensive damage to the entire site. The impact frequency is quantified in this analysis by parameter METEOR.

Thus, the total frequency of these releases is simply the sum of the three contributing threats.

$$\text{COMMAC} + \text{MILIAC} + \text{METEOR}$$

8.6.4 General Characteristics of Releases

This release mechanism involves airborne activity releases from all waste trenches. The specific releases are characterized more completely in Section 9.

8.7 SCENARIO INTERDEPENDENCIES

The QRA models account for complex interdependencies that affect several of the SDA risk scenarios. The most important of these interdependencies involve the following conditions.

- Events that damage the geomembranes
- Events that disrupt the trench clay caps
- Precipitation intensity
- Cumulative precipitation

This section explains how these interdependencies are evaluated within the QRA scenario framework.

8.7.1 Damaging Events without Correlated Precipitation

The QRA models assume that the following disruptive events will damage large sections of the geomembranes and cause substantial disruption of the trench compacted clay caps.

- Aircraft crashes
- Meteorite impacts
- Seismic events

These events are not directly correlated to storms. However, the extensive damage from these events leaves the trenches vulnerable to water intrusion from subsequent precipitation. These events may also cause direct releases of radioactive materials.

It is conservatively assumed that commercial aircraft crashes, military aircraft crashes, and meteorite impacts may cause sufficient damage to directly release airborne activity from the waste trenches. The frequency and consequences from these releases are evaluated by Release Mechanism 5.

Severe seismic events may cause failures of the slopes adjacent to the SDA site, with corresponding direct releases of solid and liquid waste materials. The frequency and consequences from these releases are evaluated by two groups of scenarios in Release Mechanism 4, depending on the extent of the seismic damage.

Seismic events that do not cause extensive slope failures may involve sufficient ground motion to damage the geomembranes and cause localized fracturing of the SDA surface. Therefore, it is conservatively assumed that strong seismic events which do not directly contribute to Release Mechanism 4 leave the geomembranes and clay caps damaged. All aircraft crashes and meteorite impacts also leave the geomembranes and clay caps damaged.

The damage from these events increases the vulnerability for water intrusion into the waste trenches from precipitation that occurs during the time until the site is re-graded and the geomembranes are restored. The frequency and consequences from the combined damage and precipitation depend on the initial water levels in the trenches, the duration of the exposure period, and the amount of precipitation that occurs during that period. Three scenarios in Release Mechanism 3 explicitly account for the frequency and consequences from meteorological conditions that produce enough precipitation to overflow the trenches. If the

amount of precipitation is not sufficient to overflow the trenches before the geomembranes are restored, these conditions contribute to elevated water levels in the trenches.

Figure 8.7-1 illustrates the treatment of these interdependencies.

8.7.2 Damaging Events with Correlated Precipitation

The QRA models assume that the following disruptive events will damage large sections of the geomembranes.

- High winds
- Tornadoes

High winds and tornadoes are not likely to cause extensive damage to the trench clay caps more than two or three feet below the SDA ground surface. However, these weather phenomena are typically generated by severe storm cells that also produce hail and very intense rainfalls. These combined conditions may cause extensive erosion of the caps if their surfaces are damaged. Therefore, the QRA models evaluate these storms separately from other disruptive events, because SDA surface damage and intense precipitation may occur during the same event.

The evaluation of these storms depends on the intensity of the accompanying precipitation. Release Mechanism 4 accounts for the frequency and consequences from extremely intense precipitation that is severe enough to cause extensive erosion of gullies in the slopes adjacent to the SDA site and direct breaches of the waste trenches.

If the storm intensity is not severe enough to cause damaging erosion of the slope gullies, the precipitation may cause localized erosion of the trench clay caps. This erosion leaves the trenches vulnerable to water intrusion from precipitation that occurs during the damaging storm, or subsequent precipitation that occurs during the time until the wind-damaged geomembranes are restored.

The frequency and consequences from the combined wind damage and precipitation depend on the initial water levels in the trenches, the intensity of the storm precipitation, the duration of the exposure period, and the amount of precipitation that occurs during that period. Three scenarios in Release Mechanism 3 explicitly account for the frequency and consequences from meteorological conditions that produce enough precipitation to overflow the trenches. If the amount of precipitation is not sufficient to overflow the trenches before the geomembranes are restored, these conditions contribute to elevated water levels in the trenches.

Figure 8.7-2 illustrates the treatment of these interdependencies.

8.7.3 Precipitation without Correlated Damage

Section 8.7.2 describes the evaluation of severe storms that involve damaging winds and accompanying intense precipitation. The precipitation events discussed in this section do not directly damage the geomembranes.

The effects from precipitation depend on the status of the geomembranes, the precipitation intensity, and the cumulative amount of precipitation that occurs during a period when the SDA

trench surfaces are exposed. If the geomembranes are intact, extremely intense precipitation may cause extensive erosion of gullies in the slopes adjacent to the SDA site and direct breaches of the waste trenches. The gully erosion scenarios in Release Mechanism 4 account for the frequency and consequences from these storms.

The QRA evaluates several disruptive events and planned replacement activities that may remove large sections of the geomembranes for extended periods of time. Section 8.7.1 describes the treatment of specific events that damage the geomembranes and disrupt the trench clay caps. The other contributors to geomembrane unavailability do not affect the integrity of the clay caps.

If the geomembranes are damaged and the clay caps are intact, the frequency and consequences from precipitation depend on the initial water levels in the trenches, the intensity of the precipitation, the duration of the exposure period, and the amount of precipitation that occurs during that period. If the precipitation intensity is not severe enough to cause damaging erosion of the slope gullies, the precipitation may cause localized erosion of the trench clay caps. This erosion leaves the trenches vulnerable to water intrusion from precipitation that occurs during a single storm period, or subsequent precipitation that occurs during the time until the geomembranes are restored. Three scenarios in Release Mechanism 3 explicitly account for the frequency and consequences from meteorological conditions that produce enough precipitation to erode the caps and overflow the trenches. If the amount of precipitation is not sufficient to overflow the trenches before the geomembranes are restored, these conditions contribute to elevated water levels in the trenches.

Figure 8.7-3 illustrates the treatment of these interdependencies.

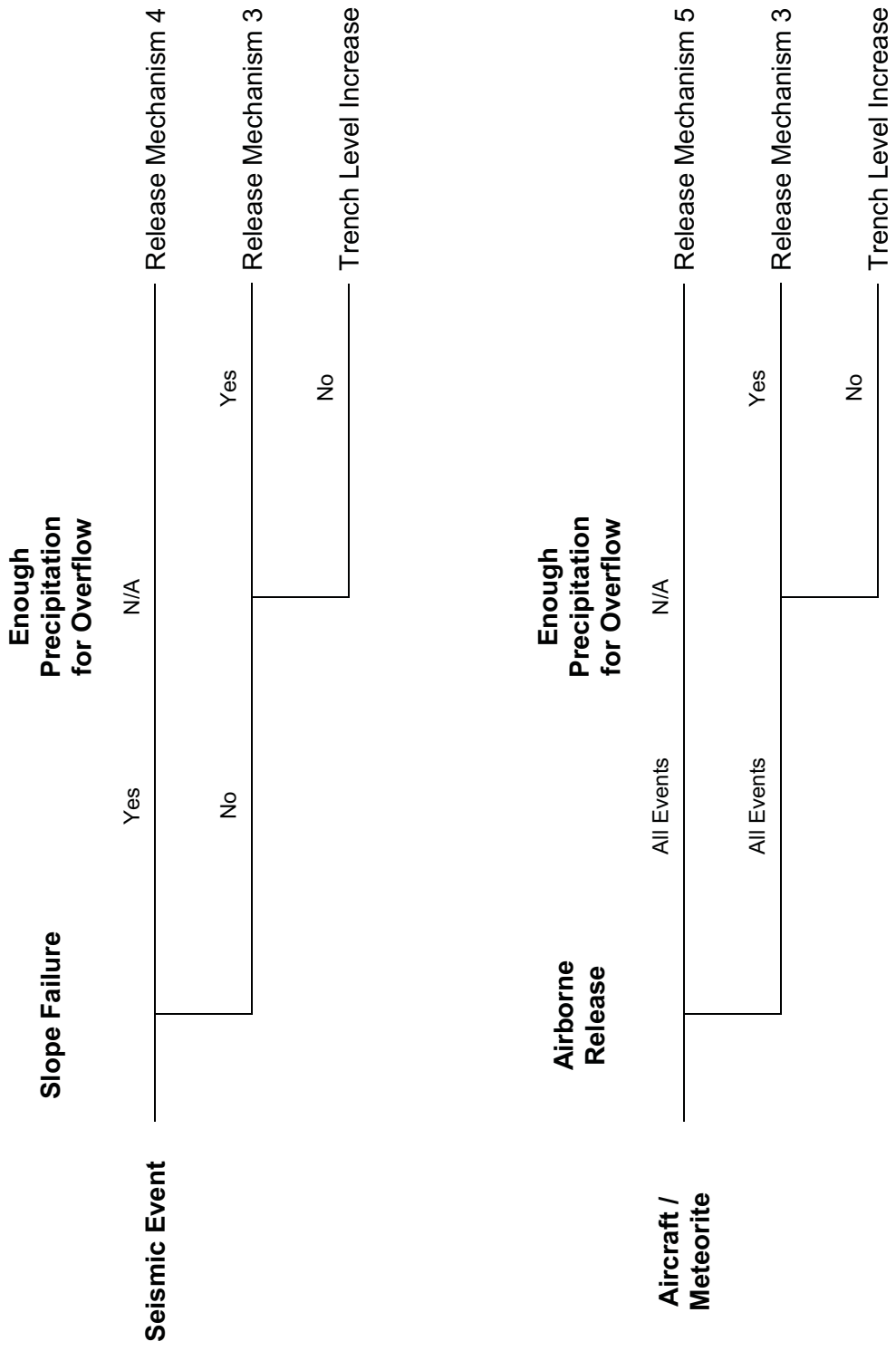

Figure 8.7-1. Damaging Events without Correlated Precipitation

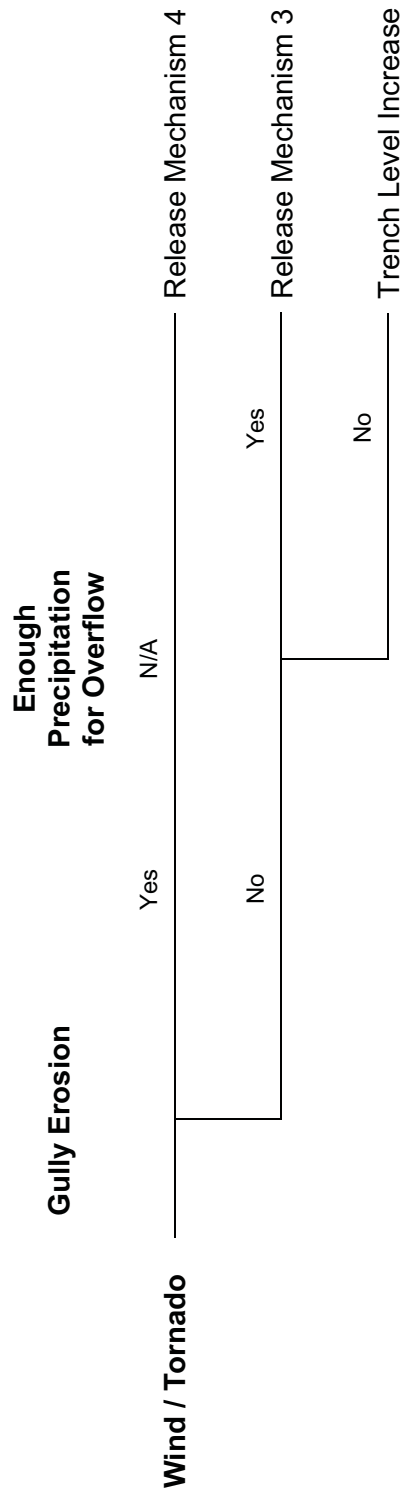

Figure 8.7-2. Damaging Events with Correlated Precipitation

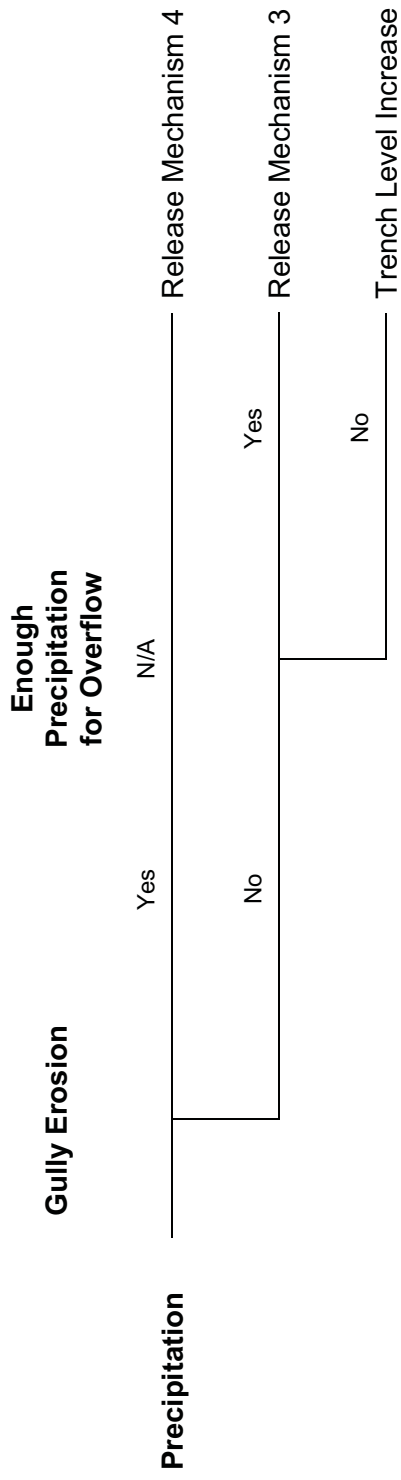

Figure 8.7-3. Precipitation without Correlated Damage

SECTION 9

RELEASE CATEGORIES

Quantification of key components of the radioactive material releases potentially associated with each of the scenarios described in Section 8 is required to quantify radiation doses that could result.

The key components of a radionuclide release that substantially affect the radiation dose that could result from the release are:

- The material matrix within which the radioactive material is contained (water, soil, etc.)
- The forms, distributions, and concentrations of radionuclides within the non-radioactive material matrix
- The release mechanism and associated physical characteristics of the release
- The time characteristics rate of release—rate and duration

As part of a QRA, this release quantification must include quantification of uncertainties that constitute significant potential contributors to uncertainty in the QRA results.

Although QRA of the nature undertaken here typically includes evaluation of constituent releases from a broad range of scenarios associated with a broad range of threats, scenarios can often be grouped so that one release scenario can serve as a reasonable representative for a significant number of event scenarios. Ultimately this grouping process leads to a limited number of release categories. But this group, taken together, reasonably represents all of a much larger number of release scenarios constituting the full range within the scope of the QRA. The grouping also facilitates the transport and impact assessment portions of the QRA.

The major sources of information required for this quantification and categorization are characterization data related to trench contents and characterization of physical processes associated with the various event scenarios under evaluation. Consideration of the transport and radiation dose quantification processes is also required to identify the specific kinds and forms of release data that are required. In practice, the process is integrated and somewhat iterative. For example, the selection of receptor scenarios for evaluation of radiation exposure must also take into consideration the potential forms and mechanisms of radionuclide release. These topics are discussed briefly below in Section 9.1. Detailed quantification is discussed in Sections 9.2 and 9.3.

9.1 GENERAL DISCUSSION

Trench contents are described in general terms in Section 4. The trenches contain solid waste materials in a wide variety of physical forms bearing a wide variety of radionuclides in various physical forms. Added soil fills the volume of the trenches not filled with waste. Infiltration water saturates materials in the lower portions of the trenches. Over time, water infiltration and deterioration of the waste containers have resulted in migration of radionuclides from waste materials to trench water and fill solids. Consequently both trench solids and trench water are material matrices potentially important to radiation dose from releases from the trenches.

Release mechanism and associated physical characteristics of the release are important in determining the fate of the released radioactive material. Release mechanisms have been discussed in earlier sections where the focus was directed primarily toward how releases might occur and how they might be mitigated. The focus on release mechanisms in this section is aimed more toward what the radionuclide releases might be.

Consideration of trench contents and potential release mechanisms leads to a limited number of release types:

- Flow of trench water through groundwater
- Flow of trench water overflow over land surfaces
- Flow of trench solids and trench water through trench wall breaches
- Ejection of trench solids into air through explosive cap breach

Coordinated consideration of the release types, the environmental setting of the SDA, and the likely radiation exposure scenarios that could occur is necessary to determine release characteristics of primary interest for dose assessment for the first three release types.

In the environmental setting of the SDA, the first three types of release would introduce radioactive material into nearby small surface streams feeding Buttermilk Creek (Frank's Creek or Erdman Brook) or into Buttermilk Creek directly. NYSERDA controls the property along the small streams and along Buttermilk Creek downstream of any likely points of entry of releases from the SDA to point just a short distance above its confluence with Cattaraugus Creek. It is assumed that NYSERDA control will continue through the 30-year period of interest. Consequently there would be no permanent inhabitants along the small streams feeding Buttermilk Creek or along Buttermilk upstream of a short reach at its end.

NYSERDA property controls would probably not prevent infrequent and short-duration access by recreational hikers along the streambeds of Buttermilk Creek and the lower reaches of Frank's Creek. The dose assessment needs to consider that such a hiker would likely receive the highest radiation dose in 1 year from radioactive materials in solids released to the streams. As explained in Sections 10 and 11, the radiation dose received by such a receptor would be proportional to the radionuclide concentration in trench solids. Consequently, the release characteristic of primary interest for these releases is the radionuclide concentration in trench solids.

Water from these small streams, from Buttermilk Creek, and from Cattaraugus Creek (which carries Buttermilk Creek outflow to Lake Erie) is not used and is not likely to be used for drinking water. But there is a small farm occupying land on both sides of Buttermilk Creek near its confluence with Cattaraugus Creek. The receptor likely to receive the highest radiation dose

in 1 year from dissolved radioactive materials in stream waters (i.e., from trench water releases) would be a farmer on Buttermilk Creek who could use creek water for crop irrigation and livestock watering. As explained in Sections 10 and 11, the radiation dose received by such a receptor would be proportional to the time-integrated radionuclide concentration in Buttermilk Creek at the point of water withdrawal. Examination of release mechanisms and the flow characteristics of the nearby small streams show that water flow rates through these paths are small relative to the flow rate of Buttermilk Creek, and need not be considered in determining the ultimate concentration of dissolved radionuclides in Buttermilk Creek. Consequently, the release characteristic of primary interest for these releases is the quantity of radioactive material introduced into Buttermilk Creek over the duration of release or 1 year, whichever is shorter.

With respect to the last release type, ejection of trench solids into air through explosive breach, as explained in Section 11, the release characteristic of primary interest for these releases is the quantity of radioactive material introduced into air. Energy associated with the release is also an important release factor, because it affects downwind dispersion substantially.

9.2 TRENCH RADIONUCLIDE INVENTORIES AND CONCENTRATIONS

Trench contents are described in general terms in Section 4. An appendix to that section (Appendix 4A) also includes a tabulation of radionuclide inventory, corrected for radioactive decay to the beginning of the year 2000, by 50-foot trench segment, and by trench. A more comprehensible subset of this list, which contains a list of 33 nuclides, including the nuclides of primary concern, is presented in Table 9.2-1. This list omits most short-lived nuclides formed as products of much longer-lived precursor nuclides. For dose assessment purposes, these nuclides are assumed to be present in equilibrium with precursor nuclides. The list also omits other nuclides unimportant to dose because of very short half-lives, very small inventories, etc. Although this list omits many nuclides tabulated in Appendix 4A, all of the nuclides listed in Appendix 4A, except for Kr-85, were included in the analysis. Kr-85 was omitted from the analysis because the SDA inventory of Kr-85 (about 72 curies) is too small to result in significant environmental radiation doses and because, being an inert gas, Kr-85 would be present in trench water or trench solids, the release materials of primary concern, only in very low concentrations. The analysis included no inventory correction for radioactive decay since the beginning of the year 2000. Scoping analyses indicated that decay correction to 2009 would result in only small dose reductions.

The complete radionuclide inventory was developed by URS as the product of an extensive effort involving examination of site disposal records, site waste shipment records, and incorporation of waste characterization information from other sources. Because site disposal records and waste shipment records frequently do not include complete radionuclide-specific quantitative information, information on absolute and relative radionuclide concentrations in various waste forms from other sources is important in quantifying trench radionuclide contents. Examination of the inventory lists shows that trench radionuclide inventories vary substantially from trench to trench and from segment to segment within a given trench. Trench volumes and masses of contained wastes and other solid diluting materials are provided in Section 4. Because these quantities are known with considerable precision, and because the fraction of the trench inventory associated with trench water is relatively small (based on measurement), variability in concentrations of radionuclides in trench solids at the trench segment, individual trench, and trench system levels can be considered comparable in the relative sense to variability in the radionuclide inventories themselves.

Levels and volumes of trench water have varied over time and the potential impact of such variation is analyzed in this study. The current trench water volume is provided in Table 4-1.

Direct measurements of radionuclide concentrations in trench water have been conducted in the past and some have been published elsewhere (Reference 9.2-1). Compilations of other measurements of radionuclide concentrations in trench water have also been assembled by NYSERDA (Reference 9.2-2). These measurements include both gross radioactivity concentration measurements and nuclide-specific measurements for nuclides likely to be important contributors to dose in the event of release. Measurement results are summarized in Table 9.2-2. The bulk of these measurements date from the 1970's and 1980's and were conducted as part of larger research projects. Trench 14 was sampled through 1993, but no measurements from other trenches date later than 1990. Concentrations of individual radionuclides in trench water vary markedly from trench to trench. Variability of these concentrations within trenches may also be high, but cannot be precisely quantified from the small number of multiple measurements from different locations within a single trench.

Because complete measurements of radionuclides in trench water are not available, and because concentrations of radionuclides in trench water must be projected into the future, other means must be used to derive sets of concentrations of radionuclides in trench water. Sets of concentrations of radionuclides entrenched water could be derived from chemical equilibrium calculations. However, the chemical environment within the trenches is complex. The chemical equilibrium calculations would be extremely difficult and the accuracy of results would be questionable and difficult to determine. Consequently, a simpler semi-empirical approach, commonly used in radioactive waste evaluations, was used for this analysis.

In this approach, the radionuclide concentration in dry solid materials is divided by a quantity called the distribution coefficient to determine the concentration in water in contact with solid. The distribution coefficient, K_d , is an empirically determined constant. In simple chemical systems, this constant has theoretical foundation. In more complex chemical systems, the quantity has a more empirical character. The results of K_d measurements for a wide variety of elements over a wide variety of conditions have been collected, evaluated, and published as commonly used compilations (References 9.2-3 and 9.2-4). The compilation used in the first study lists median values (geometric means) and estimates of variability (standard deviations of the logarithms). Estimates of K_d distributions from SDA trench data were computed for Cs137, Sr90 and H3, nuclides for which a substantial number (30-40) of water measurements were available. Decay-corrected average individual trench concentrations of radionuclides in trench solids were divided by individual measurements of concentrations of radionuclides in water from the same trench to derive individual K_d estimates, which, in turn, were used to derive distributions. Values of K_d using this analysis to derive point estimates of radionuclide concentrations entrenched water are listed in Table 9.2-3. These values are medians from the compilation or medians from the site specific analysis, as noted.

Uncertainties in concentrations of radionuclides in trench water are very large. The largest component of uncertainty is in the value of K_d . Reference tabulations indicate that K_d values are lognormally distributed and provide estimates of parameter values for these distributions. Standard deviations of the natural logarithms of K_d values typically fall in the range of 1.5 to 3. Moreover, because concentrations of radionuclides in trench water are derived from concentrations of radionuclides in trench solids, uncertainties in concentrations in trench water are also dependent upon uncertainties in concentrations of radionuclides in trench solids, or, as noted above, in trench radionuclide inventories.

The problem of characterizing these uncertainties and propagating them through transport and dose posed a significant challenge. There is little basis for quantifying uncertainties in radionuclide inventories in the trenches on a nuclide-by-nuclide basis. Consequently, there is little basis for quantifying uncertainties in concentrations of radionuclides in trench solids and water on a nuclide-by-nuclide basis. However, consideration of release mechanisms and transport characteristics indicated that nuclide-by-nuclide propagation should not be necessary. The release and transport processes move substantial quantities of trench water¹ and sometimes trench solids, but there should be little differential migration of radionuclides that requires explicit quantitative evaluation in this study. (Consideration of retardation in groundwater flow would ordinarily require such evaluation of differential migration, but in this case can be accommodated by an "all goes all the way or some goes all the way and none of the rest goes anywhere" approach. See Section 6.5 and discussion below.) The proportions of

¹ Or, in the case of groundwater, its equivalent in concentration (see Section 6.5)

radionuclides can be assumed to remain constant throughout. As a result, uncertainty in the radionuclide inventories, concentrations in trench solids, and concentrations in trench water can be incorporated by assembling a best point estimate fixed spectrum of each of these quantities, say a fixed set of nuclide inventories, and applying to each of them a distribution of multipliers (ranging from something less than 1, to something greater than 1, with a median of 1) to incorporate and propagate uncertainty. In this approach, uncertainty is evaluated and propagated for the mix as a whole, not for each component within the mix individually.

Given that the trench inventory is probably as good as it can possibly be, it is adopted as the best point estimate set of nuclide inventories. Quantifying its multiplier, M1, and its associated uncertainty distribution, CS, is difficult, but is based on a judgment that the trench inventory, taken as a whole, is known within approximately an order of magnitude, and that the uncertainty distribution should be skewed to the high side, as in a lognormal distribution. This distribution would also account for uncertainty in radionuclide concentration in trench solids. It would also account for less important uncertainties, such as the volume of the trenches and emplaced wastes, distribution of nuclides within trenches. These considerations lead to the CS distribution with parameters listed in the table below.

With respect to concentrations of radionuclides in trench water, the concentrations computed from best point estimate concentrations in trench solids and median Kd values are considered to constitute the best point estimate set of radionuclide concentrations in trench water. Uncertainty is represented by a multiplier, M2, which is lognormally distributed with a median value of 1.0.

To estimate uncertainty in the Kd multiplier, M2, a Bayesian prior, accounting for the observed variability in the range of the standard deviations of the Kd logarithms, was developed using tabulated standard deviations of Kd logarithms and corresponding lognormal error factors from all 71 data sets in Reference 9.2-3 that are derived from at least 10 observations. The resulting uncertainty distribution for M2 is the distribution KD with parameters listed in the table below. Inspection of these values reveals that the high error factor (long tail) results in a mean value for M2 far higher than the median value.

Overall uncertainty in the radionuclide concentration in trench water is $M1 / M2$, or, in terms of distributions, CS / KD . The parameters of the complete computed quotient distribution, CS / KD , are provided in the table below for the entry labeled "CS / KD." As expected, the high error factor (long tail) results in a mean value for $M1 / M2$ far higher than the median value. The last bin of the discretized CS / KD distribution (probability = 0.001), accounts for nearly 25% of the mean value, which is considered to be unreasonably high. Observation of this phenomenon in other dose assessment applications has led to general recommendations to use truncated lognormal distributions to represent uncertainty in Kd (Reference 9.2-5). Consequently, the last bin was truncated from the full CS / KD uncertainty distribution, and the probabilities were renormalized. The resultant truncated combined uncertainty distribution for $M1 / M2$ is labeled CSDIKD with parameters listed in the table below. The CS and CSDIKD distributions were used in the risk quantification.

Distribution	5th Percentile	Median	Mean	95th Percentile	Error Factor
CS ⁽¹⁾	3.16E-01	1.00E+00	1.28E+00	3.16E+00	3.2
KD	4.89E-02	1.00E+00	7.92E+00	2.04E+01	20.4
CS / KD ⁽²⁾	4.17E-02	1.00E+00	1.12E+01	2.49E+01	24.9
CSDIKD ⁽³⁾	3.87E-02	1.00E+00	8.63E+00	2.27E+01	24.2

Notes:

- (1) This distribution is used in the risk quantification with parameter name CS.
- (2) This distribution is the full uncertainty distribution for (CS / KD)
- (3) This distribution is the truncated version of (CS / KD). The last bin (probability = 0.001) was truncated from the full uncertainty distribution, and the probabilities were renormalized. This distribution is used in the risk quantification with parameter name CSDIKD.

9.2.1 References

- 9.2-1 "Ground-Water Hydrology and Subsurface Migration of Radionuclides at a Commercial Radioactive-Waste Burial Site, West Valley, Cattaraugus County, New York", Prudic, David E., USGS Survey Professional Paper 1325, U.S. Government Printing Office, Washington, D.C., 1986
- 9.2-2 Appendix A Historical Leachate Data.wpd, NYSERDA
- 9.2-3 "A Critical Compilation and Review of Default Soil Solid/Liquid Partition Coefficients, Kd, for Use in Environmental Assessments", Thibault, D.H., Sheppard, M.I., Smith, P.A., Atomic Energy of Canada Limited, AECL-10125, 1990
- 9.2-4 "Residual Radioactive Contamination from Decommissioning", Kennedy, W.E. Jr., and Strenge, D.L., NUREG/CR-5512, Vol. 1, 1992
- 9.2-5 "Development of Probabilistic RESRAD 6.0 and RESRAD-BUILD 3.0 Computer Codes," Yu, C., LePoire, D., Gnanapragasam, E., Arnish, J., Kamboj, S., Biwer, B.M., Cheng, J.-J., Zielen, A., and Chen, S.Y., NUREG/CR-6697, 2000

Table 9.2-1. Trench Radionuclide Inventory, Ci, Total (less Trenches 6 and 7) and by Trench

Nuclide	Total	T(1/2) y	1	2	3	4	5	8	9	10	11	12	13	14
H-3	3.9E+04	1.23E+01	8.7E+00	7.9E+01	9.1E+02	2.8E+03	3.8E+03	6.9E+03	3.9E+03	7.1E+03	8.6E+03	2.3E+03	1.4E+03	8.1E+02
C-14	3.0E+02	5.73E+03	2.7E+00	3.8E+00	1.2E+01	8.6E+01	2.5E+01	2.1E+01	3.4E+01	4.1E+01	4.1E+01	2.1E+01	3.8E+00	7.0E+00
Fe-55	1.8E+01	2.70E+00	1.5E-02	1.3E-01	1.8E-01	3.8E+00	7.0E+00	8.0E-01	3.6E-01	3.9E-02	3.8E-01	4.7E+00	2.4E-01	6.9E-01
Co-60	1.0E+03	5.27E+00	2.6E+00	1.9E+01	2.4E+01	2.8E+02	4.0E+02	3.4E+01	2.8E+01	1.5E+01	2.0E+01	1.5E+02	3.6E+01	2.2E+01
Ni-59	1.9E+02	7.49E+04	1.5E-01	1.2E+00	1.4E+00	5.1E+01	1.1E+02	5.6E+00	6.6E-01	3.4E-02	4.6E-01	1.6E+01	1.2E-01	1.4E+00
Ni-63	5.3E+03	1.00E+02	1.7E+01	3.6E+01	8.0E+01	1.6E+03	2.7E+03	1.6E+02	1.3E+02	8.5E+00	7.4E+01	4.2E+02	1.3E+01	5.9E+01
Sr-90	1.7E+02	2.86E+01	1.8E+00	4.1E+00	4.7E+00	5.5E+01	5.3E+00	5.1E+00	1.6E+01	1.4E+01	8.1E+00	2.3E+01	1.9E+01	1.8E+01
Zr-93	1.4E-01	1.53E+06	0	0	1.5E-07	5.2E-06	4.5E-06	6.6E-06	1.1E-06	6.3E-04	7.8E-02	1.2E-02	1.2E-02	3.9E-02
Nb-94	4.7E-01	2.03E+04	4.6E-03	3.8E-02	4.5E-02	2.3E-01	8.7E-02	9.0E-03	2.1E-02	1.1E-03	1.5E-02	9.2E-03	3.9E-03	4.9E-03
Tc-99	1.2E+00	2.13E+05	2.1E-02	6.8E-02	8.0E-02	6.8E-01	1.4E-01	2.7E-02	1.4E-01	4.8E-03	2.6E-02	1.9E-02	8.9E-03	1.8E-02
I-129	3.3E+00	1.57E+07	6.0E-02	1.9E-01	2.2E-01	1.9E+00	2.6E-01	7.1E-02	4.0E-01	1.0E-02	7.0E-02	3.2E-02	2.4E-02	4.9E-02
Cs-135	7.2E+00	2.30E+06	2.1E-02	6.9E-02	8.1E-02	6.6E-01	9.4E-02	2.5E-02	6.2E+00	3.7E-03	2.5E-02	1.2E-02	8.8E-03	1.7E-02
Cs-137	1.5E+04	3.01E+01	2.4E+02	8.0E+02	9.6E+02	8.1E+03	1.2E+03	3.3E+02	1.9E+03	6.3E+01	3.6E+02	1.8E+02	1.3E+02	2.6E+02
Pm-147	1.1E+00	2.62E+00	0	0	1.3E-06	7.1E-05	4.2E-03	2.7E-04	7.9E-04	7.8E-01	2.0E-02	1.3E-01	3.9E-02	9.8E-02
Pb-210	2.1E+01	2.22E+01	1.2E-01	1.4E-01	2.9E-01	1.1E+01	2.5E+00	8.1E-01	4.2E-01	4.5E-01	9.2E-01	1.5E+00	6.2E-01	2.1E+00
Po-210	2.1E+01	3.79E-01	1.1E-01	1.4E-01	2.8E-01	1.1E+01	2.5E+00	8.0E-01	4.1E-01	4.4E-01	9.1E-01	1.5E+00	6.1E-01	2.1E+00
Ra-226	2.7E+01	1.60E+03	1.7E-01	2.1E-01	4.3E-01	1.2E+01	2.8E+00	1.3E+00	7.0E-01	7.7E-01	1.6E+00	2.7E+00	1.1E+00	3.9E+00
Ra-228	6.4E+00	5.75E+00	6.2E-01	5.2E-03	7.2E-02	2.5E-02	6.1E-01	3.3E+00	6.4E-02	5.2E-01	1.1E-01	1.4E-01	9.2E-02	8.8E-01
Ac-227	5.5E-01	2.18E+01	3.2E-06	2.0E-06	9.7E-06	4.6E-01	9.4E-02	1.4E-04	3.6E-05	5.3E-05	3.8E-05	3.4E-05	3.5E-05	5.2E-05
Th-228	6.3E+00	1.91E+00	6.1E-01	5.2E-03	7.1E-02	2.4E-02	6.0E-01	3.2E+00	6.3E-02	5.1E-01	1.1E-01	1.4E-01	9.0E-02	8.6E-01
Th-230	1.2E+01	7.69E+04	5.2E-05	2.4E-05	2.0E-04	9.8E+00	2.0E+00	5.0E-03	1.3E-03	1.8E-03	1.4E-03	1.2E-03	1.3E-03	2.1E-03
Th-232	6.6E+00	1.40E+10	6.3E-01	5.3E-03	7.3E-02	2.5E-02	6.2E-01	3.4E+00	6.6E-02	5.4E-01	1.2E-01	1.5E-01	9.7E-02	9.2E-01
Pa-231	5.6E-01	3.27E+04	7.9E-06	4.9E-06	2.5E-05	4.6E-01	9.4E-02	3.9E-04	1.0E-04	1.5E-04	1.1E-04	1.0E-04	1.1E-04	1.6E-04
U-233	2.5E+00	1.59E+05	5.9E-10	1.1E-09	1.5E-06	5.3E-05	4.6E-05	6.7E-05	2.5E+00	1.7E-03	7.1E-04	3.7E-04	9.4E-05	1.1E-04
U-234	9.7E+01	2.44E+05	1.6E-01	7.5E-02	6.3E-01	3.4E+01	5.5E+00	1.8E+01	5.2E+00	7.8E+00	5.7E+00	5.0E+00	5.8E+00	9.1E+00
U-235	3.5E+00	7.03E+08	1.1E-02	6.5E-03	3.3E-02	1.4E+00	2.2E-01	6.2E-01	1.7E-01	2.3E-01	1.8E-01	1.8E-01	2.0E-01	3.0E-01
U-238	1.9E+02	4.46E+09	2.1E-02	7.6E-02	5.1E-01	5.9E+01	9.4E+00	4.0E+01	1.1E+01	1.4E+01	1.2E+01	1.1E+01	1.3E+01	2.1E+01
Pu-238	2.7E+04	8.77E+01	4.4E-01	9.2E-01	2.3E+00	3.2E+01	1.7E+02	4.2E+03	4.3E+03	1.2E+04	5.5E+03	2.1E+01	4.2E+00	4.3E-01
Pu-239	1.8E+02	2.41E+04	4.0E-01	1.8E+00	1.0E+01	3.1E+01	2.0E+01	2.1E+01	5.8E+01	2.8E+00	4.8E-01	2.7E+01	1.1E+01	3.5E-01
Pu-240	1.1E+02	6.56E+03	6.6E-04	1.6E-03	9.3E-01	9.3E+00	5.5E+00	1.8E+01	5.5E+01	5.6E-02	5.4E-02	1.7E+01	3.4E+00	4.0E-03
Pu-241	3.9E+03	1.44E+01	3.2E+00	6.0E+00	3.2E+01	4.0E+02	1.8E+02	5.8E+02	1.9E+03	3.3E+00	8.2E+00	6.5E+02	1.3E+02	4.9E+00
Am-241	4.4E+02	4.32E+02	8.6E-01	1.6E+00	5.4E+00	6.9E+01	2.3E+01	6.3E+01	1.9E+02	1.1E+01	9.7E+00	5.4E+01	1.1E+01	7.9E-01
Cm-242	4.1E-04	4.47E-01	0	0	1.9E-07	6.6E-06	5.7E-06	8.5E-06	1.4E-06	2.2E-04	9.1E-05	4.7E-05	1.2E-05	1.4E-05
TOTAL	9.2E+04													

From Section 4, primary nuclides only.

Table 9.2-2. Summary of Trench Water Concentration Measurement Results, pCi/L

	Jun-87		84-93 Tr 14		10-11/87		89-90		MAX ALL	PRUDIC	
	LOW	HIGH	LOW	HIGH	LOW	HIGH	LOW	HIGH		LOW	HIGH
Gross a	2.0E+02	5.0E+04	4.5E+01	4.2E+04	4.1E+01	3.3E+05	1.1E+02	2.0E+05	3.3E+05	2.0E+02	7.1E+04
Gross b	3.0E+04	1.0E+07	3.8E+05	8.8E+05	2.0E+04	8.1E+06	9.1E+04	9.8E+06	1.0E+07	2.7E+04	3.8E+07
H-3	2.0E+05	2.0E+09	2.1E+08	5.7E+08	3.2E+05	1.0E+10			1.0E+10	7.9E+07	3.7E+09
C-14			1.2E+05	6.7E+06			6.6E+03	2.2E+05	6.7E+06	2.1E+03	5.2E+05
Tc-99			8.8E+04	8.8E+04					8.8E+04		
Cs-137	6.0E+03	6.0E+04	2.2E+05	3.3E+05			3.4E+03	5.2E+05	5.2E+05	4.9E+03	1.0E+06
Sr-90	1.0E+04	5.0E+06	5.5E+04	1.8E+05			1.6E+04	5.2E+06	5.2E+06	4.5E+03	8.6E+06
Pu-tot							2.0E+02	1.2E+05	1.2E+05	2.0E+01	2.8E+05
I-129			1.8E+02	2.9E+04					2.9E+04		
Ra-226			1.1E+03	1.1E+03	2.1E+01	1.5E+03			1.5E+03		
U-238			8.7E-01	8.7E-01					8.7E-01		

APP A Document Table A-3, Prudic values for comparison

Table 9.2-3. Kd Values for Trench Water Nuclide Concentration

Nuclide	Kd silt, mL/g	Kd clay, mL/g	Kd org, mL/g	Kd min, mL/g	Kd select, mL/g
H-3	20	30	75	20	1.2
C-14	20	1	70	1	1
Fe-55	800	165	600	165	165
Co-60	1300	550	1000	550	550
Ni-59	300	650	1100	300	300
Ni-63	300	650	1100	300	300
Sr-90	20	110	150	20	9
Zr-93	2200	3300	7300	2200	2200
Nb-94	550	900	2000	550	550
Tc-99	0.1	1	1	0.1	0.1
I-129	5	1	25	1	1
Cs-135	4600	1900	270	270	270
Cs-137	4600	1900	270	270	900
Pm-147	270	270	270	270	270
Pb-210	16000	550	22000	550	550
Po-210	400	3000	7300	400	400
Ra-226	36000	9100	2400	2400	2400
Ra-228	36000	9100	2400	2400	2400
Ac-227	1500	2400	5400	1500	1500
Th-228	3300	5800	89000	3300	3300
Th-230	3300	5800	89000	3300	3300
Th-232	3300	5800	89000	3300	3300
Pa-231	1800	2700	6600	1800	1800
U-233	15	1600	410	15	15
U-234	15	1600	410	15	15
U-235	15	1600	410	15	15
U-238	15	1600	410	15	15
Pu-238	1200	5100	1900	1200	1200
Pu-239	1200	5100	1900	1200	1200
Pu-240	1200	5100	1900	1200	1200
Pu-241	1200	5100	1900	1200	1200
Am-241	9600	8400	112000	8400	8400
Cm-242	18000	6000	6000	6000	6000
Kd, mL/g, for silt, clay, and organic are median values from Sheppard and Thibault, AECL-10125, Table 8, except for Pm from Kennedy and Strenge, NUREG/CR-5512. Pm not included in AECL-10125.					
Kd min, mL/g, is the minimum median value for silt, clay, and organic materials					
Kd select values taken as Kd min, except italicized values, median values calculated from site data					

Table 9.2-4. Trench Water Nuclide Concentration Calculation

Nuclide	Trench Inv (Total-6-7) Ci	T(1/2) y	Kd select mL/g	Concentration pCi/L	Release Rate Ci/y per 0.1 FVTO/y
H-3	3.86E+04	1.23E+01	1.2	1.91E+08	1.32E+02
C-14	2.98E+02	5.73E+03	1	1.77E+06	1.23E+00
Fe-55	1.84E+01	2.70E+00	165	6.62E+02	4.59E-04
Co-60	1.03E+03	5.27E+00	550	1.12E+04	7.73E-03
Ni-59	1.89E+02	7.49E+04	300	3.74E+03	2.59E-03
Ni-63	5.28E+03	1.00E+02	300	1.05E+05	7.24E-02
Sr-90	1.74E+02	2.86E+01	9	1.15E+05	7.94E-02
Zr-93	1.42E-01	1.53E+06	2200	3.84E-01	2.66E-07
Nb-94	4.66E-01	2.03E+04	550	5.03E+00	3.49E-06
Tc-99	1.23E+00	2.13E+05	0.1	7.29E+04	5.05E-02
I-129	3.29E+00	1.57E+07	1	1.96E+04	1.35E-02
Cs-135	7.17E+00	2.30E+06	270	1.58E+02	1.09E-04
Cs-137	1.45E+04	3.01E+01	900	9.58E+04	6.64E-02
Pm-147	1.05E+00	2.62E+00	270	2.31E+01	1.60E-05
Pb-210	2.09E+01	2.22E+01	550	2.25E+02	1.56E-04
Po-210	2.08E+01	3.79E-01	400	3.08E+02	2.13E-04
Ra-226	2.73E+01	1.60E+03	2400	6.76E+01	4.68E-05
Ra-228	6.42E+00	5.75E+00	2400	1.59E+01	1.10E-05
Ac-227	5.54E-01	2.18E+01	1500	2.19E+00	1.52E-06
Th-228	6.32E+00	1.91E+00	3300	1.14E+01	7.88E-06
Th-230	1.19E+01	7.69E+04	3300	2.13E+01	1.48E-05
Th-232	6.62E+00	1.40E+10	3300	1.19E+01	8.25E-06
Pa-231	5.55E-01	3.27E+04	1800	1.83E+00	1.27E-06
U-233	2.46E+00	1.59E+05	15	9.75E+02	6.76E-04
U-234	9.75E+01	2.44E+05	15	3.86E+04	2.67E-02
U-235	3.53E+00	7.03E+08	15	1.40E+03	9.67E-04
U-238	1.92E+02	4.46E+09	15	7.59E+04	5.26E-02
Pu-238	2.65E+04	8.77E+01	1200	1.31E+05	9.10E-02
Pu-239	1.84E+02	2.41E+04	1200	9.10E+02	6.31E-04
Pu-240	1.09E+02	6.56E+03	1200	5.42E+02	3.75E-04
Pu-241	3.89E+03	1.44E+01	1200	1.92E+04	1.33E-02
Am-241	4.38E+02	4.32E+02	8400	3.10E+02	2.15E-04
Cm-242	4.10E-04	4.47E-01	6000	4.06E-04	2.81E-10
TOTAL	9.17E+04			1.94E+08	1.34E+02
Conc (pCi/L)=Trench Inv (Ci)*1E12 (pCi/Ci)/Trench solids mass (g)/Kd (mL/g)*1000 (mL/L)					
Kd select values from Table 9.2-3					
1.68E+11	Trench solids mass, g				
6.93E+09	Trench fluid volume, mL, for trenches at current fluid level				
6.93E+08	0.1 FVTO/y= 0.1 trench fluid volume (current level) turnover per year, mL/y				

9.3 RELEASE CATEGORY QUANTIFICATION

The key components of a radionuclide release that substantially affect the radiation dose that could result from the release are restated below:

- The material matrix within which the radioactive material is contained (water, soil, etc.)
- The forms, distributions, and concentrations of radionuclides within the non-radioactive material matrix
- The release mechanism and associated physical characteristics of the release
- The time characteristics rate of release—rate and duration

The first two items have been addressed above in a generic sense.

The quantities of interest for dose assessment have been identified for all types of releases:

- Water releases—the quantity (activity) of radioactive material introduced into Buttermilk Creek over the duration of release or 1 year, whichever is shorter
- Solids releases to water—radionuclide concentration in trench solids
- Solids releases to air—the quantity (activity) of radioactive material ejected into air and the energy of the explosion

In this section release mechanisms and associated information are analyzed to compile specific lists of parameters and parameter values sufficient to characterize individual releases and release categories. These are addressed first at the release mechanism level and then, as necessary, at the individual scenario level.

9.3.1 Release Mechanisms 1 and 2—Groundwater Releases

Release Mechanism 1 accounts for vertical and lateral groundwater flows through the Unweathered Lavery Till and Kent Recessional Sequence soil layers. These flows occur due to existing natural processes at the SDA site. They result in liquid releases into the adjacent streams or Buttermilk Creek. The analyses of this release mechanism account for the current status of the site, its possible conditions during the next 30 years, and the effects from developing conditions during the 30 years since the wastes were initially buried.

Release Mechanism 2 accounts for lateral groundwater flows through the Weathered Lavery Till soil layer near the surface of the SDA. These flows occur due to natural processes at the SDA site, if water levels in the trenches rise above the WLT / ULT interface. They result in liquid releases into Erdman Brook or Frank's Creek. The trench water levels are currently below the WLT / ULT interface. The analyses of this release mechanism account for possible conditions that could cause levels to increase during the next 30 years.

Releases consist of trench water, characterized above. Trench water concentration uncertainty is incorporated by application of a multiplier distribution CSDIKD, also discussed above.

Release flow rates—in terms of trench water-equivalent flow rates determined in the Neuman models (methods and results described in Section 6.5):

- 1-1 ULTLAT1
- 1-2 ULTLAT2
- 1-3 ULTLAT3
- 1-4 KRS
- 2-1 WTLAT, as fed by ULTVERT

In considering only non-sorbing contaminants in the groundwater flow/transport models described in Section 6.5 (a conservative approach), R (retardation) was set equal to the deterministic value of 1. This is considered appropriate for the models WTLAT, ULTLAT1, and ULTLAT2. In those cases, substantial portions of the flow pass through fractured media, limiting potential for retardation. For models ULTLAT3, ULTVERT, and KRS, however, flow is assumed to pass predominantly through unfractured media. Furthermore, sensitivity studies using the Neuman models show that values of K_d , (distribution coefficient, the equilibrium ratio of concentration of constituent in solids to the concentration in water in contact with the solids, units of mL/g) as low as 10 mg/L result in no constituent release over a very broad part of the range of variability in the other model parameter values. As shown in Table 9.2-3, K_d values for all but the essentially non-retarded nuclides (H3, I129, Tc99, and C14) are all greater than 10 mL/g. Most are far greater. This finding suggests that, while the full spectrum of nuclides should be considered released unretarded in the first three models, only poorly retarded nuclides should be considered released (with no retardation) in the others. For these cases, other nuclides can be considered entirely confined to the groundwater system, if not to the trenches, for the period of interest. Consequently, the set of all nuclides is used for scenarios 1-1, 1-2, and 2-1, but only non-retarded nuclides (H3, I129, Tc99, and C14) are considered released for scenarios 1-3 and 1-4.

Release durations for the groundwater scenarios are considered to be limited by potential mitigative action. A probability distribution for groundwater scenarios, designated TDETM1, is described in Section 8.2.2.3.

Summary

Trench water, discussed above

Nuclide set—all for scenarios 1-1, 1-2, 2-1, non-retarded for 1-3, 1-4, discussed here

Trench water concentration uncertainty—multiplier distribution CSDIKD, discussed above

Release flow rate—trench water-equivalent flow rate determined in Neuman models—methods and results in Section 6.5:

- 1-1 ULTLAT1
- 1-2 ULTLAT2
- 1-3 ULTLAT3
- 1-4 KRS
- 2-1 WTLAT

Release durations—limited by response times

1-4 TNDEMI—Section 8.2.2.3 (may exceed 1 year)
Others TDEMI, Section 8.2.2.2

9.3.2 Release Mechanism 3—Trench Overflow

This release mechanism involves liquid overflows from the tops of the waste trenches due to rapid water intrusion. All scenarios for Release Mechanism 3 are initiated by precipitation or severe storms. Significant water intrusion into the waste trenches can occur only if the geomembrane covers are removed from a large portion of the SDA surface area. The compacted clay caps also provide an effective secondary barrier against water intrusion, if they are intact. These scenarios result in liquid releases into Erdman Brook or Frank's Creek via surface water runoff.

Releases consist of trench water, characterized above. Trench water concentration uncertainty is incorporated by application of a multiplier distribution CSDIKD, also discussed above. The entire set of radionuclides is considered available for release in all of these scenarios.

Release flow rate—determined by release volume and release duration

Overflow release volumes were selected for each scenario, based on the range of precipitation rates associated with the dominant initiating events for the scenario, and calculations of overflow volumes as a function of initial trench water levels and precipitation totals.

A release duration of 14 days, considered to be the maximum threat exposure period, was chosen for most of these scenarios, but durations of 1-2 days were selected for several. Release volumes, durations, and flowrates are discussed in detail in Section 8.4.

Summary

Trench water, discussed above

Nuclide set—all for all scenarios, discussed here

Trench water concentration uncertainty— multiplier distribution CSDIKD, discussed above

Release flow rate—determined by release volume and release duration

Release volumes—determined by initial trench water level and precipitation rates for dominant initiating events, per scenario

Release durations—maximum threat exposure period of 14 days for most scenarios (see Section 8.4)

9.3.3 Release Mechanism 4—Trench Wall Breach-Solids Releases

This release mechanism involves physical breaches of the waste trenches. The scenarios for Release Mechanism 4 are initiated by disruptive events and natural processes that destabilize the slopes on the North end of the site, adjacent to Erdman Brook, and at the East side of the

site, along Frank's Creek. Releases occur if the slope damage extends far enough into the SDA site area to physically breach the trench walls and mobilize the waste materials. These scenarios result in liquid releases into the adjacent streams and disruption of solid materials that may be dispersed throughout the drainage basin by subsequent precipitation and storms.

This release mechanism involves physical breaches of the waste trenches and releases of liquid and solid radioactive materials. Four different release conditions are identified to account for the amount of waste material affected and potential impacts on its distribution after release.

- **Release Condition 4a:** This release involves the material in Trenches 1/2, Trench 8, and 125 feet of the North ends of Trenches 3, 4, and 5. These releases are caused by seismic-induced slope failures and localized landslides that are not directly correlated to precipitation events.
- **Release Condition 4b:** This release involves the material in Trenches 1/2, Trench 8, and 125 feet of the North ends of Trenches 3, 4, and 5. These releases are caused by gully erosion. They occur as a direct consequence of precipitation that exceeds 16 inches during a 24-hour or 48-hour severe storm event.
- **Release Condition 4c:** This release involves the material in Trenches 1/2, Trench 3, Trench 8, Trench 9, and 250 feet of the North ends of Trenches 4 and 5. These releases are caused by seismic-induced slope failures that are not directly correlated to precipitation events.
- **Release Condition 4d:** This release involves the material in all trenches. These releases are caused by regionally disruptive "global" landslides that are not directly correlated to precipitation events.

For the scenarios under consideration here, releases consist of trench solids, characterized above. (See below for consideration of releases of trench water from these events.) Trench solid concentration uncertainty is incorporated by application of a multiplier distribution CS, also discussed above. The entire set of radionuclides is considered available for release in all of these scenarios. However, because different portions of the trench system are involved in three of these scenarios, three sets of scenario-specific average concentrations of radionuclides in trench solids were calculated based on inventories in the trenches and segments of trenches involved in the wall breaches. One set was calculated for Release Scenarios 4-1 and 4-2 (same release for both), one for Scenario 4-3, and one for Scenario 4-4. These release scenarios correspond to Release Conditions 4a through 4d in the description above. Concentrations of primary nuclides are listed in Table 9.3-1.

Summary

Trench solids, discussed above

Nuclide set—all for all scenarios—three sets of concentrations reflecting different trench volumes affected; one for 4-1 and 4-2 (same release for both), one for 4-3, and one for 4-4, discussed here

Trench solid concentration uncertainty— multiplier distribution CS, discussed above

9.3.4 Release Mechanism 4—Trench Wall Breach-Water Releases

See scenario description above.

Releases consist of trench water, characterized above. Trench system average water concentrations were used in the analysis. Trench water concentration uncertainty is incorporated by application of a multiplier distribution CSDIKD, also discussed above. The entire set of radionuclides is considered available for release in all of these scenarios.

No detailed analyses were performed to evaluate the amount of time during which leachate from the breached trenches will drain into the adjacent streams. Two nominal durations are used for the analyses of liquid releases during these scenarios.

- For scenarios that affect up to two rows of trenches, it is assumed that the leachate will drain completely within 48 hours after the initial breach.
- For extremely severe scenarios that affect the entire site, it is assumed that the leachate will drain completely within 24 hours after the initial breach.

These durations are judged to provide conservative bounds for the integrated release rates that would occur during a particular breach scenario, with an initial release of fluid that accompanies the trench wastes and soils, followed by more gradual releases of the remaining liquid through the new slope geometry and debris field.

The volumes of water released vary by trench water level status and by the size of the portion of the trench system affected by the event. Release water volumes were computed for each of the damage states and three water level states (see Section 6.6). Implicit flow rates were computed from the water volumes and the assumed release durations described above. As in the case of solids releases, Scenarios 4-1a, b, and c are identical to 4-2a, b, and c. Affected trench areas, computed water release volumes, the release durations described above, and the implicit resulting flow rates for these nine scenarios are tabulated below. It should be noted that the water release volume is the only fundamental difference between these scenarios.

Liquid Releases	QRA Scenario	Liquids - Level 1 (Full) (cubic feet)	Liquids - Level 2 (WLT/ULT Contact) (cubic feet)	Liquids - Level 3 (2008 Level) (cubic feet)	Duration, (days)	Liquids - Level 1 (Full) (cfs)	Liquids - Level 2 (WLT/ULT Contact) (cfs)	Liquids - Level 3 (2008 Level) (cfs)
All fluids from Trenches 1/2, 3, 4, 5, 8, and 9	4-3	5.24E+05	2.67E+05	1.10E+05	2.0	3.03	1.54	0.64

All fluids from Trenches 1/2, 3, 4, 5, and 8	4-1, 4-2	4.47E+05	2.13E+05	1.01E+05	2.0	2.59	1.23	0.59
All fluids from all trenches	4-4	9.29E+05	5.69E+05	2.45E+05	1.0	10.75	6.58	2.83
Data from Trench Volumes - AAT.xls								

Summary

Trench water, discussed above

Nuclide set—all for all scenarios, discussed above

Trench water concentration uncertainty— multiplier distribution CSDIKD, discussed above

Release flow rate—determined by release volume and release duration

Release volumes differ for three water level states and three trench damage states. The 4-1a,b,c scenarios are the same as the 4-2a,b,c scenarios. Release volumes and bases tabulated above and discussed here

Release durations—estimated 1 day for all scenarios, reflects likely short release duration precluding mitigation response, discussed here

9.3.5 Release Mechanism 5—Trench Cap Breach-Airborne Release

This release mechanism involves severe physical disruption of the SDA site surface to the extent that waste materials are exposed to the environment. All scenarios for Release Mechanism 5 are initiated by high energy impacts on the SDA. These events cause an immediate release of airborne activity from the trenches. They also cause substantial damage to the geomembrane covers and physically disturb the site surface. Release Mechanism 3 accounts for subsequent releases that may be caused by precipitation that occurs before the site is restored to its normal configuration.

The representative release for this scenario is the explosion of a large quantity of aircraft fuel in an airplane crash on the trenches. It is assumed that the crash strips the cap off of an area of the trenches and that the subsequent explosion of fuel results in ejection of trench solids into the air. Development of release characteristics for this scenario is described below.

Fuel Load and Explosive Energy Equivalence

Usable fuel capacities for various commercial aircraft are available online at http://www.boeing.com/commercial/airports/plan_manuals.html. Values (pounds, assuming 6.7 pounds per gallon) for a range of aircraft are listed below:

DC-9-15:	24,743
DC-9-51:	24,649
DC-10-10:	145,202
DC-10-30:	245,568
707-320B:	159,828
727-200,	54,846 & 65,700
737-200:	23,182 to 34,572
737-300:	35,584
747-200:	351,150 (with CF6-50E2: 348,635)
747-300:	327,000 (with CF6-50E2: 324,480)
747-400:	360,226 (382,336-GE/383,810-RR&PW with tail fuel)
747-400ER:	425,182 (423,708-GE)
747SP:	326,622 (with CF6-45A2/B2: 334,870; with RB211-524C2: 337,410)
757-200:	75,550
757-300:	76,980
767-200/-400ER:	161,738
767-300ER:	161,740

A value of 100,000 lbs was selected as the best point estimate of fuel load, based on capacities above, the likelihood of load being some fraction of capacity, and relatively infrequent operation of 747-class aircraft. Sensitivity analysis indicates that higher fuel loads would lead to lower consequences because of higher plume rise and greater atmospheric dispersion.

The energy of the fuel load explosion, in terms of kg TNT equivalent, was calculated as shown below:

Heat of detonation of TNT, J/g	4184
Heat of combustion of jet fuel, J/g	43600
Heat of combustion of jet fuel, kcal/g	10.41567
TNT equivalence, kg TNT per kg jet fuel at 10.4 kcal/g	9.5
TNT equivalence of fuel load, kg TNT	4.31E+05

TNT equivalence from http://www.ime.org/dynamic.php?page_id=9

Crater Dimensions

The dimensions of the crater in trench solids created by the explosion were calculated using a submodel of the SCM (Source Characterization Model) (Reference 9.3-1). The submodel uses functions fit to experimental data. Important parameters include energy release, soil type, and distance above the ground to the blast. Parameters for soil type VI (wet sand, moist, cohesive soils, and ice) were selected as most representative for this analysis. The calculation is shown in the table below:

Crater Dimensions	
10	db, distance above ground of blast, m
4.31E+05	W, energy release, kg TNT equiv, from FUEL-TNT
1.32E-01	lam, scaling factor, $db/W^{(.33333)}$
4.93E-01	Rs, scaled crater radius, m, $=a_0+a_1*lam+a_2*lam^2+a_3*lam^3$
0.629	a0
-1.08	a1
0.264	a2
1.12	a3
Coefficients above based on soil type VI	
1.56E-01	Ds, scaled crater depth, m, $=b_0+b_1*lam+b_2*lam^2+b_3*lam^3+b_4*lam^4$
0.331	b0
-1.49	b1
0.579	b2
4.92	b3
3.13	b4
Coefficients above based on soil type VI	
3.73E+01	R, crater radius, m, $=Rs*W^{0.33333}$
1.18E+01	D, crater depth, m, $=Ds*W^{0.33333}$
3.44E+04	V, crater volume, m ³ , $=0.5*4/3*PI*D*R^2$
4.36E+03	A, source area, m ² , $=PI*R^2$

The mass of trench solids ejected into the air can be calculated from the crater volume, the fraction of the crater material that is trench material, material density, and relationships from another SCM submode, as shown below:

Trench Solids Ejection Mass	
Total Aerosol Mass	
3.44E+04	V, crater volume, m ³ , from above
1.6	rhos-soil density, kg/m ³
1	effcase, ejection efficiency due to casing of explosive
1	ejection efficiency due to cover sod
0.3	effsilt, ejection efficiency due to arrest of small particles
0.5	Effpartition
0.12	effsoil, ejection efficiency of soil, =effcompact*efflip*effagglom
0.6	effcompact, ejection efficiency due to compaction by explosion
0.4	efflip, ejection efficiency due to crater lip deposition
0.5	effagglom, ejection efficiency due to explosive dynamic loading of particles
9.89E+02	M, aerosol mass, kg, =rho*V*effcase*effsod*effsilt*effpartition*effsoil
Trench Solid Fraction	
0.5	FT, fraction of aerosol mass from trench solids, remainder being non-trench solids
Trench Solid Mass Ejected	
4.95E+02	Mtr, mass of trench solids ejected, kg, =M*FT

The key results from this analysis are Mtr, the mass of trench solids ejected and the TNT equivalence of the fuel load, a factor important in the transport analysis.

Summary

Trench solids, discussed above

Nuclide set—all for all scenarios, discussed above

Trench solid concentration uncertainty— multiplier distribution CS, discussed above

Mass ejected and energy release, discussed here

9.3.6 Release Summary

Release data are summarized scenario-by-scenario in Table 9.3-2. The release data tabulated there are directly transferrable to the remaining stages of the risk quantification process.

9.3.7 References

- 9.3-1 "Source Characterization Model (SCM), A Predictive Capability for the Source Terms of Residual Energetic Materials from Burning and/or Detonation Activities", Brown, R.C., et al., Final Report, ARI-RR-1384, Aerodyne Research, Inc., 2004

Nuclide	Cs1-Scenarios 4-1, 4-2	Cs2-Scenario 4-3	Cs3-Scenario 4-4
H-3	1.89E-07	1.72E-07	2.29E-07
C-14	1.63E-09	1.81E-09	1.77E-09
Fe-55	7.76E-11	5.74E-11	1.09E-10
Co-60	4.90E-09	4.25E-09	6.14E-09
Ni-59	9.80E-10	6.04E-10	1.12E-09
Ni-63	3.00E-08	2.11E-08	3.14E-08
Sr-90	9.50E-10	1.01E-09	1.03E-09
Zr-93	1.81E-16	1.26E-16	8.44E-13
Nb-94	3.24E-12	4.04E-12	2.77E-12
Tc-99	1.07E-11	1.18E-11	7.29E-12
I-129	2.98E-11	3.32E-11	1.96E-11
Cs-135	1.04E-11	9.12E-11	4.26E-11
Cs-137	1.26E-07	1.44E-07	8.62E-08
Pm-147	6.82E-15	1.43E-14	6.24E-12
Pb-210	5.79E-11	5.21E-11	1.24E-10
Po-210	5.76E-11	5.18E-11	1.23E-10
Ra-226	7.43E-11	6.73E-11	1.62E-10
Ra-228	9.57E-11	5.40E-11	3.81E-11
Ac-227	1.41E-12	1.25E-12	3.29E-12
Th-228	9.44E-11	5.33E-11	3.76E-11
Th-230	3.03E-11	2.67E-11	7.04E-11
Th-232	9.82E-11	5.54E-11	3.93E-11
Th-234	1.07E-09	7.84E-10	1.14E-09
U-233	1.85E-15	3.25E-11	1.46E-11
U-234	5.26E-10	3.92E-10	5.79E-10
U-235	1.90E-11	1.43E-11	2.09E-11
U-238	1.07E-09	7.84E-10	1.14E-09
Pu-238	1.06E-07	1.15E-07	1.58E-07
Pu-239	9.13E-10	1.54E-09	1.09E-09
Pu-240	5.64E-10	1.07E-09	6.50E-10
Pu-241	1.88E-08	3.73E-08	2.31E-08
Am-241	2.32E-09	4.11E-09	2.60E-09
Cm-242	2.33E-16	1.62E-16	2.44E-15
Primary nuclides only			

Table 9.3-2. Summary of Release Category Data (Page 1 of 5)

Scenarios	Release Type	Parameters	Distributions
1 – 1	Liquid	$C_w(\text{all}) = C_s / K_d$	Point estimate
		M1 / M2	CSDIKD
		FR	ULTLAT1
		T	TDETM1
1 – 2	Liquid	$C_w(\text{all}) = C_s / K_d$	Point estimate
		M1 / M2	CSDIKD
		FR	ULTLAT2
		T	TDETM1
1 – 3	Liquid	$C_w(\text{nret}) = C_s / K_d$	Point estimate
		M1 / M2	CSDIKD
		FR	ULTLAT3
		T	TDETM1
1 – 4	Liquid	$C_w(\text{nret}) = C_s / K_d$	Point estimate
		M1 / M2	CSDIKD
		FR	ULTKRS
		T	TDETM1
2 – 1	Liquid	$C_w(\text{all}) = C_s / K_d$	Point estimate
		M1 / M2	CSDIKD
		FR	WLTLAT
		T	TDETM1
3 – 1	Liquid	$C_w(\text{all}) = C_s / K_d$	Point estimate
		M1 / M2	CSDIKD
		FR	See text
		T	See text
3 – 2	Liquid	$C_w(\text{all}) = C_s / K_d$	Point estimate
		M1 / M2	CSDIKD
		FR	See text
		T	See text

Table 9.3-2. Summary of Release Category Data (Page 2 of 5)

3 – 3	Liquid	$C_w(\text{all}) = C_s / K_d$	Point estimate
		M1 / M2	CSDIKD
		FR	See text
		T	See text
3 – 4	Liquid	$C_w(\text{all}) = C_s / K_d$	Point estimate
		M1 / M2	CSDIKD
		FR	See text
		T	See text
3 – 5	Liquid	$C_w(\text{all}) = C_s / K_d$	Point estimate
		M1 / M2	CSDIKD
		FR	See text
		T	See text
3 – 6	Liquid	$C_w(\text{all}) = C_s / K_d$	Point estimate
		M1 / M2	CSDIKD
		FR	0.10 cfs
		T	14 d
3 – 7	Liquid	$C_w(\text{all}) = C_s / K_d$	Point estimate
		M1 / M2	CSDIKD
		FR	See text
		T	See text
3 – 8	Liquid	$C_w(\text{all}) = C_s / K_d$	Point estimate
		M1 / M2	CSDIKD
		FR	See text
		T	See text
3 – 9	Liquid	$C_w(\text{all}) = C_s / K_d$	Point estimate
		M1 / M2	CSDIKD
		FR	See text
		T	See text

Table 9.3-2. Summary of Release Category Data (Page 3 of 5)

4 – 1	Solid	Cs1	Point estimate
		M1	CS
4 – 1a	Liquid	$C_w(\text{all}) = C_s / K_d$	Point estimate
		M1 / M2	CSDIKD
		FR	2.6 cfs
		T	2 days
4 – 1b	Liquid	$C_w(\text{all}) = C_s / K_d$	Point estimate
		M1 / M2	CSDIKD
		FR	1.25 cfs
		T	2 days
4 – 1c	Liquid	$C_w(\text{all}) = C_s / K_d$	Point estimate
		M1 / M2	CSDIKD
		FR	0.60 cfs
		T	2 days
4 – 2	Solid	Cs1	Point estimate
		M1	CS
4 – 2a	Liquid	$C_w(\text{all}) = C_s / K_d$	Point estimate
		M1 / M2	CSDIKD
		FR	2.6 cfs
		T	2 days
4 – 2b	Liquid	$C_w(\text{all}) = C_s / K_d$	Point estimate
		M1 / M2	CSDIKD
		FR	1.25 cfs
		T	2 days
4 – 2c	Liquid	$C_w(\text{all}) = C_s / K_d$	Point estimate
		M1 / M2	CSDIKD
		FR	0.60 cfs
		T	2 days

Table 9.3-2. Summary of Release Category Data (Page 4 of 5)

4 – 3	Solid	Cs2	Point estimate
		M1	CS
4 – 3a	Liquid	$C_w(\text{all}) = C_s / K_d$	Point estimate
		M1 / M2	CSDIKD
		FR	3.1 cfs
		T	2 days
4 – 3b	Liquid	$C_w = C_s / K_d$	Point estimate
		M1 / M2	CSDIKD
		FR	1.5 cfs
		T	2 days
4 – 3c	Liquid	$C_w(\text{all}) = C_s / K_d$	Point estimate
		M1 / M2	CSDIKD
		FR	0.65 cfs
		T	2 days
4 – 4	Solid	Cs3	Point estimate
		M1	CS
4 – 4a	Liquid	$C_w(\text{all}) = C_s / K_d$	Point estimate
		M1 / M2	CSDIKD
		FR	10.7 cfs
		T	1 day
4 – 4b	Liquid	$C_w(\text{all}) = C_s / K_d$	Point estimate
		M1 / M2	CSDIKD
		FR	6.6 cfs
		T	1 day
4 – 4c	Liquid	$C_w(\text{all}) = C_s / K_d$	Point estimate
		M1 / M2	CSDIKD
		FR	2.8 cfs
		T	1 day

Table 9.3-2. Summary of Release Category Data (Page 5 of 5)

5 – 1	Airborne	Cs	Point estimate
		M1	CS
		Mtr	495 kg

SECTION 10

TRANSPORT ANALYSES

Transport analyses considered two general mechanisms by which a human receptor could experience exposure as a result of releases to the environment attributed to the presence of SDA trenches. For these analyses, the "environment" was considered to be the stream channel areas in the valleys of Erdman Brook and Frank's Creek adjacent to the SDA, and the stream channel area in the valley of Buttermilk Creek at a location northeast of the SDA. In these three areas, SDA releases in the form of trench solids or trench liquids could reach the surface-water bodies. The specific mechanisms considered by which the released solids or liquids might be transported from the release point to a possible exposure point were:

- Transport of impacted liquids (containing dissolved radionuclides) as a portion of surface-water flow moving downstream under various flow conditions, and
- Transport of impacted solids (containing radionuclides) as suspended sediment or bed load by surface-water flow moving downstream under various flow conditions.

The transport of liquids or solids originating at SDA release points was analyzed using surface-water modeling methods to determine the surface-water flow rates (volume over time) under flow conditions resulting from normal precipitation events and under flow conditions resulting from precipitation events with different frequencies of occurrence. The computer program Hydrologic Modeling System (HEC-HMS), Version 3.2 (Reference 10-1) was utilized to determine stream hydrographs for selected precipitation events. The computer program River Analysis System (HEC-RAS), Version 4.0 (Reference 10-2) was used to model the stream flooding potential resulting from precipitation events and quantify potential solids (sediment) mobilization and transport.

HEC-HMS is a graphical user interface (GUI) model that conducts hydrologic simulations of watersheds, calculating inputs from upstream to downstream. The user inputs watershed physical attributes, meteorology data, and the time span over which the simulation is made. For the watershed physical attributes, the user can consider infiltration losses, surface runoff, base flow contributions, routing methods, and the presence of water impoundments. The meteorology capabilities of HEC-HMS include consideration of actual precipitation history or producing synthetic precipitation history including snow accumulation or snowmelt, and computing potential evapotranspiration.

HEC-RAS is GUI model that is capable of one-dimensional hydraulic calculations for a full watershed of natural and engineered channels, including steady and unsteady flow calculations, sediment transport and mobile bed computations, and water-quality analysis. The user inputs the geometry of the watershed using stream cross sections, reach lengths, Manning's roughness coefficients, storage areas, stream junction lengths, and bridge and culvert specifications. The user considers various flow conditions by model inputs that consider normal flow depth for the streams, stream hydrographs from the output of HEC-HMS for normal or storm conditions, and setting a stage series or rating curve for the stream. The user also specifies sediment size and density data. The HEC-RAS transport simulation function includes a sorting method and fall velocity method.

10.1 WATERSHED PARAMETERS

Both HEC-HMS and HEC-RAS require detailed information about the physical characteristics of the watershed. For the SDA analyses, stream segment lengths, cross sections and slopes were taken from the USGS National Hydrography Dataset and from USGS topographic maps contained in the TOPO!™ software created by National Geographic. Manning's Roughness Coefficients for the stream and the overbank areas were estimated using USGS Water-Supply Paper 2339, "Guide for Selecting Manning's Roughness Coefficients for Natural Channels and Flood Plains" (1989). Stream basin areas were determined by importing topographic maps from TOPO!™ and stream locations from the National Hydrography Dataset into Arc-GIS 9.1™.

Drainage divides were created manually for each stream basin, and Arc-GIS was used to calculate the basin areas. Since no water temperature data were available for the Buttermilk Creek watershed, average water temperature was determined using USGS temperature data for a steam gaging station on Allen Creek near Rochester, NY. Allen Creek is similar to Buttermilk Creek.

Surface-water bodies in the Buttermilk Creek basin (Figure 10.1-1) that were considered in the HEC-HMS and HEC-RAS modeling included: Buttermilk Creek (main channel), Frank's Creek, Quarry Creek, Erdman Brook, and several unnamed Buttermilk Creek tributaries.

10.2 STREAM MODELING

To model the open-channel flow and develop the stream hydrographs that would be the input to HEC-RAS, the Muskingum-Cunge routing method was selected in HEC-HMS to calculate the channel flow for each of the streams. The Muskingum-Cunge routing method was selected because it did not require hydrograph data for the system, and it could model flow and flood events for low stream gradients. According to the HEC-HMS Technical Reference Manual, the Muskingum-Cunge model is based upon solution of the following form of the continuity equation, with lateral inflow, q_L , included:

$$\frac{\partial A}{\partial t} + \frac{\partial Q}{\partial x} = q_L$$

where q_L is the lateral inflow, t is time, x is the distance along the flow path, A is cross sectional area, and Q is flow, and the diffusion form of the momentum equation:

$$S_f = S_o - \frac{\partial y}{\partial x}$$

where S_f is the energy gradient or friction slope, S_o is the bottom slope, y is the hydraulic depth, and x is the distance along the flow path.

Combining these and using a linear approximation yields the convective diffusion equation (Miller and Cunge, 1975):

$$\frac{\partial Q}{\partial t} + c \frac{\partial Q}{\partial x} = \frac{\partial^2 Q}{\partial x^2} + cq_L$$

where c = wave celerity (speed); and μ = hydraulic diffusivity. The wave celerity and the hydraulic diffusivity are expressed as follows:

$$c = \frac{dQ}{dA}$$

and

$$= \frac{Q}{2BS_o}$$

where B = top width of the water surface.

A finite difference approximation of the partial derivatives, combined with the solution of the Muskingum model, is as follows:

$$O_t = \left(\frac{t - 2KX}{2K(1-X) + t} \right) I_t + \left(\frac{t + 2KX}{2K(1-X) + t} \right) I_{t-1} + \left(\frac{2K(1-X) - t}{2K(1-X) + t} \right) O_{t-1}$$

where O_t is the outflow hydrograph ordinate at time t , O_{t-1} is the outflow hydrograph ordinate at time $t-1$, K is the travel time of the flood wave through routing reach, I_t is the inflow hydrograph ordinate at time t , I_{t-1} is the inflow hydrograph at time $t-1$, and X is the dimensionless weight.

Solving yields:

$$O_t = C_1 I_{t-1} + C_2 I_t + C_3 O_{t-1} + C_4 (q_L \ x)$$

The coefficients are:

$$C_1 = \frac{\frac{t}{K} + 2X}{\frac{t}{K} + 2(1-X)}$$

$$C_2 = \frac{\frac{t}{K} - 2X}{\frac{t}{K} + 2(1-X)}$$

$$C_3 = \frac{2(1-X) - \frac{t}{K}}{\frac{t}{K} + 2(1-X)}$$

$$C_4 = \frac{2^{\left(\frac{t}{K}\right)}}{\frac{t}{K} + 2(1 - X)}$$

The parameters K (the travel time of the flood wave through routing reach) and X (dimensionless weight) are (Cunge, 1969; Ponce, 1978, as cited in HEC-HMS Technical Reference Manual):

$$K = \frac{x}{c}$$

$$X = \frac{1}{2} \left(1 - \frac{Q}{BS_o c x} \right)$$

But c , Q , and B change over time, so the coefficients C_1 , C_2 , C_3 , and C_4 must also change. The program recomputes them at each time and distance step, Δt and Δx , using the algorithm proposed by Ponce (1986), as cited in the HEC-HMS Technical Reference Manual.

The choice of the time and distance steps in the model is critical. The steps are selected to ensure accuracy and stability. The Δt is selected as the minimum of the following: user time step from the control specifications; the travel time through the reach; or $1/20^{\text{th}}$ the time to rise of the peak inflow with the steepest rising limb, rounded to the nearest multiple or divisor of the user time step. Once Δt is chosen, Δx is computed as:

$$x = c \ t$$

The value is constrained so that:

$$x < \frac{1}{2} \left(c \ t + \frac{Q_o}{BS_o c} \right)$$

Here Q_o is reference flow, computed from the inflow hydrograph as:

$$Q_o = Q_B + \frac{1}{2} (Q_{peak} - Q_B)$$

where Q_B is base flow and Q_{peak} is the inflow peak.

Base flow data was estimated using USGS data for New York streams since no field data were collected. Average stream discharges were calculated for streams with drainage basins from 0.10 to 30 square miles and 200 square miles to 600 square miles. The linear relationship between basin area and average stream discharge for New York State streams was determined using Microsoft Excel™. Using the relationship developed, the basin sizes for the Buttermilk Creek stream were used to determine average (base flow) discharge. This calculated base flow was input the HEC-HMS model as a constant monthly base flow.

Hydrographs determined by HEC-HMS were the input to HEC-RAS for each Buttermilk Creek base stream for each storm event. These became the boundary condition for the sediment transport modeling by HEC-RAS. At the final cross section at the confluence of Buttermilk and Cattaraugus Creeks, a stage series boundary condition was input as the boundary condition. The stage series was created by running the model with a normal depth boundary condition (setting the friction slope equal to the stream slope), and then extracting the HEC-RAS output water stage at different times during the simulation.

Some of the functions of HEC-HMS and HEC-RAS models were not considered in the flow or sediment transport modeling. No data were available for stream flow constraints, such as dams, weirs, culverts or bridges. Also, ice cover within the basin or stream was not considered. Infiltration was not considered for local soils; therefore, the no Loss Method was selected for HEC-HMS, and all precipitation was considered to become runoff.

10.3 PRECIPITATION EVENTS

Six hypothetical precipitation conditions were considered in the models to determine the range of stream flows within the watershed that could transport liquids or sediment. These precipitation conditions included:

- No precipitation
- 2 inches over 24 hours
- 4 inches over 24 hours
- 8 inches over 24 hours
- 12 inches over 24 hours
- 16 inches over 24 hours
- 24.9 inches over 24 hours

These storm amounts were input to HEC-HMS as Frequency-Based Hypothetical Storms. The intensity position for each storm was set at 50% and the intensity position was set at 5 minutes. The storm coverage area was set to be equal to the area of each sub-basin within the Buttermilk Creek watershed. Since all of the sub-basins within the Buttermilk Creek watershed were smaller than 9.6 square miles, HEC-HMS did not apply an area correction for the storm events. This approach is consistent with recommendations of the World Meteorological Organization. A storm probability of 0.002 was assumed for each storm; however the probability was not used in the HEC-HMS calculations. HEC-HMS uses the alternating block method by Chow, Maidment, and Mays, 1988, to develop a hyetograph for the storm.

10.4 SOLIDS TRANSPORT

For modeling of sediment mobilization and transport, the particle-size distribution for SDA trench contents were assumed as follows: 50% of the solids were assumed to be evenly distributed over the range between 0.0625 mm and 1.0 mm in diameter, and 50% of the solids were assumed to be evenly distributed between 1.0 mm diameter and 64.0 mm in diameter. It was assumed that no solids smaller than 0.0625mm were present because HEC-RAS cannot accurately model deposition of silt- and clay sized sediment. Typically, these material sizes are assumed to be transported without deposition to a downstream reservoir where deposition in still water would occur. The specific gravity of waste solids was set at 2.0 gm/cc. The shape factor of the sediment was set at the HEC-RAS default setting of 0.6.

HEC-RAS uses the Ackers-White sediment transport function used, which is a total load function developed under the assumption that fine sediment transport is best related to the turbulent fluctuations in the water column and coarse sediment transport is best related to the net grain shear with the mean velocity used as the representative variable. The general transport equation for the Ackers-White function for a single grain size is represented by:

$$X = \frac{G_{gr} s d_s}{D \left(\frac{u_*}{V} \right)^n} \quad \text{and} \quad G_{gr} = C \left(\frac{F_{gr}}{A} - 1 \right)$$

where X is the sediment concentration, in parts per part, G_{gr} is the sediment transport parameter, s is the specific gravity of sediments, d_s is the mean particle diameter, D is effective depth, u_* is the shear velocity, V is the average channel velocity, n is the transition exponent, C is the coefficient, F_{gr} is the sediment mobility parameter, and A is the critical sediment mobility parameter.

The sorting method for the sediment transport model is Exner 5, a three-layer bed-mixing algorithm, which was designed to account for the influences of static armoring. The maximum amount of scour mass is the amount of material that is above the equilibrium depth. The equilibrium depth is defined as the smallest depth at which all particle sizes in the bed surface mixture will resist erosion for the given hydraulic forces imposed on the bed. Equilibrium depth (D_e) is computed by combining Manning's equation for flow velocity, Strickler's equation for grain roughness, and Einstein's Transport Intensity equation:

Manning's Equation

$$V = \frac{1.49}{n} R^{\frac{2}{3}} S_f^{\frac{1}{2}}$$

Strickler's Roughness Equation

$$n = \frac{d^{\frac{1}{6}}}{29.3}$$

Einstein's Transport Intensity Equation

$$\phi = \frac{\rho_s - \rho_w}{\rho_w}$$

where V is velocity, R is hydraulic radius, S_f is friction slope, n is Manning's n value, d is representative particle size, ρ_s is grain density, ρ_w is water density, and D is depth.

Particle erosion, in the Einstein Equation, is assumed for $\psi \geq 30$. The sediment particles are treated as quartz sand, for which the specific gravity is 2.65. The value of the submerged particle density term in the equation ($\rho_s - \rho_w / \rho_w$) is 1.65. Substitution allows Einstein's Transport Intensity equation to be reduced to:

$$S_f = \frac{d}{18.18D}$$

These three equations can be solved for unit water discharge by replacing the sub-sectional hydraulic radius in the Manning equation with the panel depth, D , and the n -value with Strickler's equation.

$$q = \frac{1.49}{\left(\frac{1}{d^6}\right)} \cdot D^{\frac{5}{3}} \cdot \left(\frac{d}{18.18D}\right)^{\frac{1}{2}}$$

$$\frac{29.3}{29.3}$$

or

$$q = 10.21 \cdot D^{\frac{7}{6}} \cdot d^{\frac{1}{3}}$$

where: q is the water discharge in cubic feet per second per foot of width.

If all sediment particles in the bed were the same size, the equilibrium depth would be

$$D_e = \left(\frac{q}{10.21 \cdot d_i^{\frac{1}{3}}}\right)$$

where D_e is the equilibrium depth for particle size, i .

The fall velocity method used in the sediment transport simulation is the Rubey method. The Rubey method is an analytical relationship between the fluid, sediment properties, and the fall velocity based on the combination of Stoke's law for fine particles subject only to viscous resistance and an impact formula for large particles outside the Stoke's region. The Rubey method is as follows:

$$\omega = F_1 \sqrt{(s-1)gd_s}$$

in which

$$F_1 = \sqrt{\frac{2}{3} + \frac{36}{gd^3(s-1)}} - \sqrt{\frac{36}{gd^3(s-1)}}$$

where s is the specific gravity of particles, ν is the kinematic viscosity, ω is the particle fall velocity, d is the particle diameter, and g is the gravitational acceleration.

HEC-RAS was developed to model sediment transportation as it erodes and deposits within a stream. To model a release scenario, the sediment was set to either erode or not erode. For all stream reaches except where there was contamination, the streams could erode up to 10 feet of sediment to estimate natural stream loading. At contamination points where the release might occur, sediment could erode up to 20 feet. To compare release scenarios with non-release scenarios, the model was run with contamination erosion and with no contamination erosion.

10.5 MODELING RESULTS

10.5.1 Stream Flows

Stream-flow rates were determined by HEC-HMS at various points in the Buttermilk Creek basin stream, including a series of locations between the SDA and the confluence of Buttermilk and Cattaraugus Creeks. The points considered most important to the results of the transport analyses were those adjacent to the SDA, near the confluence of Frank's Creek and Buttermilk Creek, and near the confluence of Buttermilk and Cattaraugus Creeks. The flow rates at these points for the series of storm events considered are shown in Table 10.5-1.

In these modeling results, stream flow at rates above the normal flow condition typically began between 1 and 2 hours after the beginning of the 24-hour storm event and continued for several days. During the period, flows steadily increased to the peak flows in Table 10.5-1, remained at near the peak flows for a short period, and then steadily decreased to normal flow levels. The modeled duration of flow rates above normal is indicated below.

Precipitation Condition	Duration of Peak Flow (hours)
2-in / 24-hr Storm	162
4-in / 24-hr Storm	158
8-in / 24-hr Storm	160
12-in / 24-hr Storm	161
16-in / 24-hr Storm	158
24.9-in / 24-hr Storm	150

10.5.2 Liquid Transport

Fluid transport analyses considered introduction of various SDA trench fluids volumes into the surface-water body, with the release volume dependent upon the nature of the release under consideration. The releases considered ranged from the continuous, but low volume, discharge of groundwater mixed with trench fluids directly into the surface-water body, to one-time rapid release of the entire fluid contents of one or more SDA trenches directly into the surface-water body as a result of a catastrophic trench failure. The release volume and timing were considered together with stream flow (under differing flow conditions) to estimate the dilution of trench fluids at the potential points of exposure.

10.5.3 Solids Transport

Solids transport analyses also considered introduction of various SDA trench solids volumes into a location proximal to surface-water body, with the release volume dependent upon the nature of the release. All of the mechanisms considered that would result in solids releases were catastrophic, but highly unlikely, events (e.g., slope failure resulting from earthquakes). These failures potentially would cause the movement (slumping or sliding) of large volumes of trench contents solids into the surface-water bodies adjoining the SDA. Then, surface-water flow (by the mechanisms discussed above) would cause the mobilization (erosion) of the trench solids and the transport of the mobilized solids to new positions along stream segments downstream from the source. The re-deposition of the mobilized solids would depend on stream-flow conditions (e.g., stream gradient, flow volume, flow velocity, water depth, etc., as discussed above).

Under the solids transport analyses, the released trench solids also were subject to various types of dilution (mixing of trench solids with native solids). Causes of solids dilution considered included the following.

- Mixing of disposed wastes with native soil used as trench fill material. Considering the entire SDA, the approximate ratio of wastes to non-waste native soil fill placed in disposal trenches is 7:4, or about 63.5% waste material.
- Mixing of released trench solids with native soil as a result of the release mechanism. For slope failures, the ratio of the volumes of native soil that could become mixed with trench solids to the volume of trench solids released was determined to range from 2:1 to more than 9:1 (33% to less than 10% of trench solids).

Table 10.5-2 summarizes the possible mixing (dilution) of SDA wastes with non-waste soil materials as a result of the release scenarios considered by the QRA. Notations such as "250 feet of trench" and "all of trench" indicate the portion of the SDA trench contents solids that are released under the scenario considered.

In these release and transport analyses, the waste and non-waste solids considered as "trench solids" are assumed to have identical characteristics with regard to radionuclide content. That is, all materials in the SDA trenches are considered to be "waste". Waste dilution caused by the release is the released waste volume divided by the combined volume of released waste and non-waste soil that becomes mixed with waste as a result of the release. The dilution occurring under the first scenario listed in Table 10-5-2, "North 250 feet of Trenches 4 and 5", is $(10,887 + 2,879 \text{ tons}) \div (10,887 + 2,879 + 27,533 \text{ tons})$ or a three times dilution. Thus, if the radionuclide content in the waste before release was C_0 , the average radionuclide content in the material mass moved into the creek valley by the release would be $C_0 \div 3.0$ or $0.33C_0$.

Further dilution of trench solids with non-trench solids occurred as the source solids (i.e., the solids released at the SDA) would become mixed with solids (sediment) eroded from other parts of the Buttermilk Creek basin. The contribution of the SDA area, as a source of erodible solids, becomes less significant with increasing distance downstream from the SDA. For example, the SDA surface area is about 15 acres and the combined Erdman Brook and Frank's Creek basins upstream from the SDA comprise about 1,200 acres. The SDA area comprises about 1.3% of the contributing drainage basin upstream of the confluence of Erdman Brook and Frank's Creek.

The fraction of the upstream drainage basin made up of the 15-acre SDA becomes much smaller with distance downstream from the SDA. At the confluence of Buttermilk and Cattaraugus Creeks, the upstream Buttermilk Creek drainage basin includes about 31.4 square miles. At that point, the fraction of the basin made up of the 15-acre SDA is only about 0.075%.

At re-deposition points downstream from the SDA, the mixing of solids mobilized and transported from the SDA area with native soil solids (transported as stream sediment) will further dilute the materials released at the SDA. The HEC-RAS model determined that this mixing of stream-carried sediment was different for each stream segment considered and for each stream-flow condition considered, and ranged from ratios of native soil sediment to sediment originating at the SDA source from 0:1 (i.e., no dilution of sediment from SDA source, no native soil sediment present) to 1:0 (i.e., infinite dilution, no sediment from the SDA source present).

Table 10.5-3 represents typical sediment erosion/deposition results for the HEC-RAS model. As these results indicate, the model determinations of sediment deposition vary significantly between stream segments for the different flow conditions considered.

Consideration of the stream flow and sediment deposition results allows differentiation of two distinct stream segments in the surface-water pathway between the SDA and the confluence of Buttermilk Creek with Cattaraugus Creek. These are Frank's Creek between the SDA and Buttermilk Creek, and Buttermilk Creek below the confluence with Frank's Creek.

Considering Stream Flow

Stream flows increase slowly, but steadily, along Frank's Creek between the SDA and Buttermilk Creek as the size of the upstream drainage basin increases. Then, at the confluence with Buttermilk Creek, the stream flow immediately increases by a factor of more than 10.0 under essentially all flow conditions. That is, downstream from the confluence with Frank's Creek, more than 90% of the Buttermilk Creek flow originates in portions of the upstream basin other than the Frank's Creek segment.

Considering Sediment Deposition

In general, deposition of sediment originating at the SDA occurs under all stream flow conditions considered. Stream flow volume does influence where SDA-originated sediment is deposited, but sediment from this source is deposited along some stream segments under each flow condition. Also, the relative amounts of deposition (as percentage of total deposition) in segments where deposition occurs seems to be somewhat independent of stream flow. For example, in Frank's Creek segments, SDA-originated sediment comprises 20 to 40% of the deposited sediment under five of the seven flow conditions considered. Similarly, along the Buttermilk Creek segments, SDA-originated sediment comprises between 1 and 5% of the deposited sediment under six of the seven flow conditions considered.

Based on these observations for modeled sediment deposition estimates for the two main stream segments considered, conservative assumptions were made with regard to the deposition of "diluted sediment" originating at the SDA source that could be deposited along various stream segments. These assumptions are summarized below.

- For dose assessment purposes, all stream reaches, including those showing scour (erosion) rather than deposition, were assumed to be subject to a uniform deposition.

- Human receptors in the Frank's Creek stream segments were assumed to encounter sediment consisting of 50% SDA source solids and 50% sediment not originating at the SDA.
- Human receptors in the Buttermilk Creek stream segments were assumed to encounter sediment consisting of 10% SDA source solids and 90% sediment not originating at the SDA.

10.6 REFERENCES

- 10-1. Hydrologic Modeling System (HEC-HMS), Version 3.2, Hydrologic Engineering Center, U.S. Army Corps of Engineers, 2008
- 10-2. River Analysis System (HEC-RAS), Version 4.0, Hydrologic Engineering Center, U.S. Army Corps of Engineers, 2008

Table 10.5-1. Stream Flow Determined by HEC-HMS

Precipitation Condition	Stream Flow Rate (cubic feet / second)			
	Erdman Brook at SDA	Frank's Creek at Confluence with Buttermilk Creek	Buttermilk Creek at Confluence with Frank's Creek	Buttermilk Creek at Cattaraugus Creek
Normal Flow	0.4	7.3	50.9	57.3
2-in / 24-hour Storm	12.0	137.8	1,472.5	1,577.8
4-in / 24-hour Storm	23.7	268.2	2,894.6	3,101.8
8-in / 24-hour Storm	46.9	528.9	5,738.7	6,150.0
12-in / 24-hour Storm	70.1	789.7	8,583.1	9,198.4
16-in / 24-hour Storm	93.4	1050.5	11,426.8	12,246.9
24.9-in / 24-hour Storm	145.1	1630.8	17,756.3	19,029.7

Table 10.5-2. Solids Combined by Releases from Direct Trench Wall Breach

Release by Slope Failure or Erosion	Trench Solids Released (tons)		Non-Trench (Dilution) Solids (tons)
	Waste	Non-Waste	
Case 1 Solids			
* North 250 feet of Trenches 4 and 5	10,887	2,879	27,533
* All of Trenches 1/2, 3, 8, and 9	39,807	29,749	891,733
Case 2 Solids			
* North 125 feet of Trenches 3, 4, and 5	7,243	3,082	20,650
* All of Trenches 1/2 and 8	21,082	13,785	281,193
Case 3 Solids			
* North 25 feet of Trenches 1/2, 3, 4, and 5	1,867	886	5,507
Case 4 Solids			
* All trenches	117,787	67,663	--
Note: All volumes are in tons at assumed waste and soil density = 1.6			

Table 10.5-3. Typical HEC-RAS Model Result – Sediment Deposition

Stream Segment	Distance from SDA (feet)	Computed 12-Day Sediment Deposition Total from SDA Source Following a Single Storm													
		Normal flow		2-inch, 24-hour Storm		4-inch, 24-hour Storm		8-inch, 24-hour Storm		12-inch, 24-hour Storm		16-inch, 24-hour Storm		24.9-inch, 24-hour Storm	
		SDA (ton)	SDA (%)	SDA (ton)	SDA (%)	SDA (ton)	SDA (%)	SDA (ton)	SDA (%)	SDA (ton)	SDA (%)	SDA (ton)	SDA (%)	SDA (ton)	SDA (%)
EU2	0	21.6	87.6%	230.0	85.3%	21.8	69.5%	204.7	94.5%	375.7	96.2%	295.6	92.8%	117.3	89.5%
EU1	422	0.0	0.0%	0.0	0.0%	0.0	0.0%	0.0	0.0%	0.0	0.0%	0.0	0.0%	0.0	0.0%
F9_2	1,267	0.0	0.0%	0.0	0.0%	0.0	0.0%	0.0	0.0%	0.0	0.0%	0.0	0.0%	0.0	0.0%
F9_1	2,323	37.6	1.6%	15.9	0.7%	111.7	5.5%	191.8	9.2%	38.7	2.0%	211.4	20.8%	595.6	39.6%
F8_2	3,115	0.0	0.0%	0.0	0.0%	0.0	0.0%	0.0	0.0%	0.0	0.0%	0.0	0.0%	0.0	0.0%
F8_1	3,696	0.0	0.0%	52.7	23.2%	3.7	3.5%	23.8	9.1%	62.2	49.7%	42.9	24.8%	0.0	0.0%
F7_2	5,016	655.0	27.9%	0.0	0.0%	249.7	9.1%	0.0	0.0%	0.0	0.0%	19.3	1.4%	62.2	2.8%
F7_1	5,702	17.1	20.5%	0.0	0.0%	0.0	0.0%	0.0	0.0%	0.0	0.0%	0.0	0.0%	0.0	0.0%
CS9	7,128	0.0	0.0%	0.0	0.0%	0.0	0.0%	0.0	0.0%	0.0	0.0%	0.0	0.0%	0.0	0.0%
CS8	8,290	0.0	0.0%	0.0	0.0%	0.0	0.0%	0.0	0.0%	45.2	3.3%	31.2	1.7%	0.0	0.0%
CS6	11,616	0.0	0.0%	0.0	0.0%	0.0	0.0%	0.0	0.0%	0.0	0.0%	0.0	0.0%	0.0	0.0%
CS5	14,150	0.0	0.0%	601.8	3.6%	269.6	0.9%	0.0	0.0%	0.0	0.0%	699.3	1.1%	2,255.3	2.2%
CS3	16,368	0.0	0.0%	0.0	0.0%	0.0	0.0%	0.0	0.0%	0.0	0.0%	0.0	0.0%	0.0	0.0%
CS2	17,371	5.4	1.2%	0.0	0.0%	0.0	0.0%	0.0	0.0%	0.0	0.0%	0.0	0.0%	0.0	0.0%
CS1	20,011	0.0	0.0%	24.2	1.5%	652.0	5.8%	2,450.9	12.1%	0.0	0.0%	0.0	0.0%	0.0	0.0%

Notes:

SDA (ton) = Tons deposited sediment originating at SDA "source"
 SDA (%) = Percent of deposited sediment originating at SDA "source"
 EU = Erdman Brook F = Frank's Creek CS = Buttermilk Creek

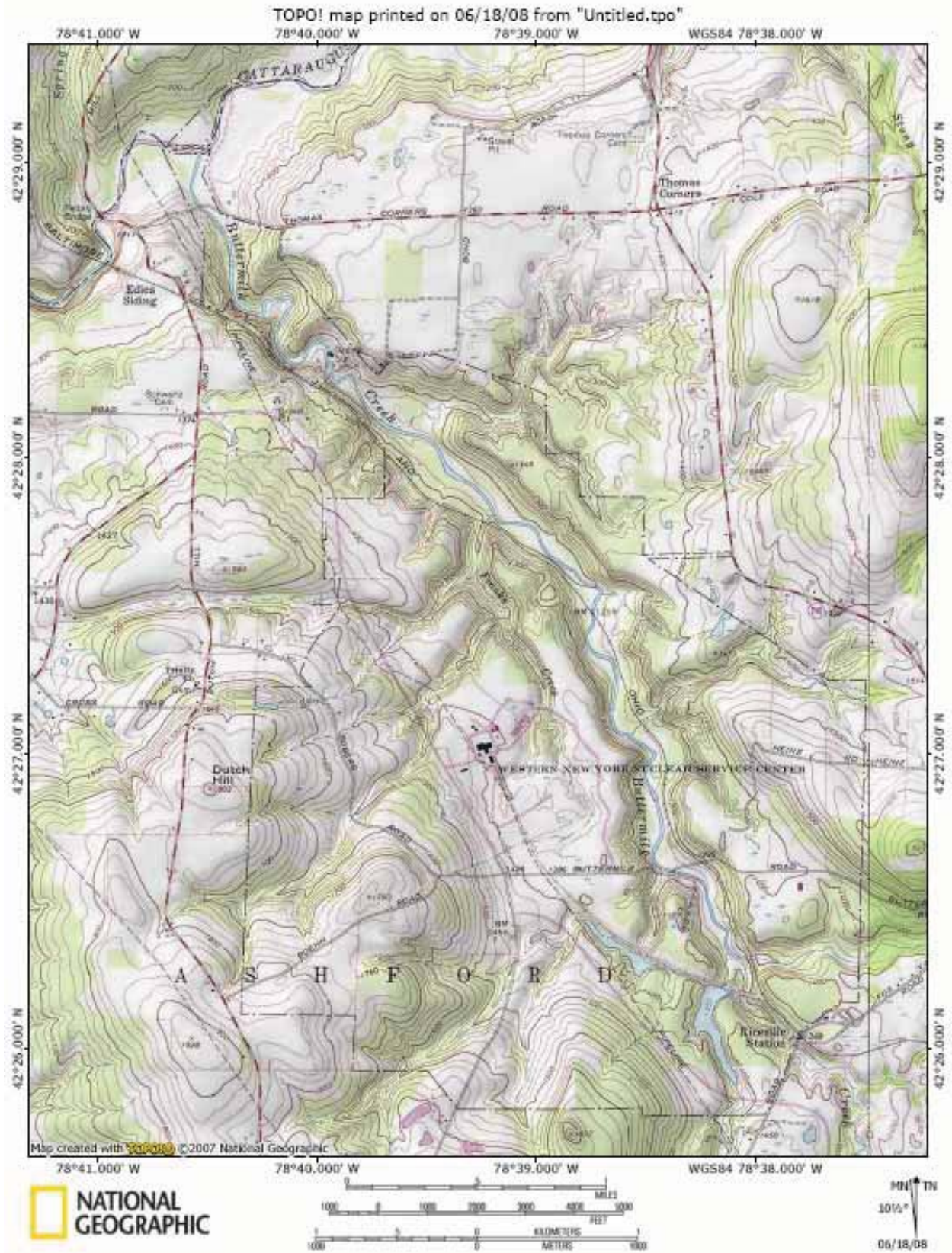

Figure 10.1-1. Buttermilk Creek Basin Topographic Map

SECTION 11

DOSE ANALYSIS

This section describes the analyses conducted to quantify radiation doses to members of the public who may be exposed to the radionuclides that could be released from the SDA. In this QRA, radiation dose is the consequence end point, the X, in the risk definition triplet described in Section 2:

$$R = \{ \langle S_i, L_i, X_i \rangle \}_c,$$

As stated in Section 3, the scope of this risk assessment is limited to quantification of the radiation dose received by a member of the public.

11.1 INTRODUCTION

The scope of this QRA, as defined in Section 3, has defined certain aspects of the environmental radiation dose assessment as discussed below. Some of these definitions would normally be based on evaluations conducted as a part of the dose assessment process, but past studies have largely accomplished that, and need not be reproduced, except to the extent that analysis reveals the need.

11.1.1 Consequence Endpoint

The radiation dose to be calculated is the maximum 1-year total effective dose equivalent from all exposure pathways related to releases from the SDA. For purposes of assessing doses to members of the public, TEDE means the sum of the effective dose equivalent (for external exposures) and the committed effective dose equivalent (for internal exposures). The effective dose equivalent is the sum of the products of the dose equivalent to the organ or tissue and the weighting factors applicable to each of the body organs or tissues that are irradiated. The committed effective dose equivalent is the sum of the products of the weighting factors applicable to each of the body organs or tissues that are irradiated and the committed dose equivalent to these organs or tissues. The committed dose equivalent is the dose equivalent that is committed to specific organs or tissues that will be received from an intake of radioactive material by an individual during the 50 years following the intake. Definition of dose in these terms implies adoption of ICRP 30 methodology (References 11.1-1 through 11.1-8) for definition and quantification of radiation dose. Although a newer ICRP methodology has been developed and is being used in some applications, the ICRP 30 methodology is currently the basis for all generally applicable U.S. radiation protection standards.

The maximum 1-year TEDE, for which the term "dose" is used elsewhere in the report, was chosen as the consequence endpoint because radiation protection standards controlling dose apply to dose over a 1-year period. For example, the U.S. Nuclear Regulatory Commission limit for dose for members of the public, expressed in 10 CFR Part 20, is 100 millirem per year.

11.1.2 Site Administrative Controls and Operations

Site operating processes, procedures, and technologies are assumed to be the same as those of today. Inspection, maintenance, monitoring, mitigation, and security activities in effect as of

June 2008 will continue for the duration of the 30-year study period. Effectiveness of these activities is based on their present and past effectiveness. Evaluations of future planned activities that may affect the SDA during the next 30 years are based on the best available current information about the specific types of activities, their scopes, and schedules.

11.1.3 Transport Pathways

This study evaluates potential releases of liquid, solid, and gaseous radioactive materials from the SDA site. The analyses account for distribution, dilution, and deposition of liquid and solid contaminants throughout the interconnected watershed formed by Erdman Brook, Frank's Creek, and Buttermilk Creek. Water flows through the stream systems during the next 30 years are based on the current configurations of the creek channels and valley walls, including downstream flows through Cattaraugus Creek and upstream tributaries. Stream flow rates are based on historically measured values and regional weather data.

11.1.4 Locations and Characteristics of Receptors

This study evaluates potential radiation doses to two receptors.

One receptor is a permanent resident farmer, located near the confluence of Buttermilk Creek and Cattaraugus Creek. Potential doses to this receptor accrue from direct exposure to contaminated creek water and sediments. It is also assumed that creek water is used exclusively for crop irrigation and livestock water supplies, resulting in additional potential doses through these food chain pathways. It is assumed that the farm does not use creek water as its domestic potable water supply. A farmer currently residing at this location does not use the creek for drinking water. He draws water from an underground spring. People who live in rural areas (especially in the northeastern US) do not typically use creek water for drinking or any other domestic purposes. Creek water is well known to contain numerous harmful bacteria, fertilizer residues, and industrial contaminants (in addition to silt and other particulates). Efforts to purify creek water sufficiently for domestic consumption are typically prohibitively expensive, compared to other readily available sources of good water, such as wells and springs.

The second receptor is a transient recreational hiker / hunter who traverses areas along Buttermilk Creek and the lower reaches of Frank's Creek. The range of this receptor extends within the West Valley site property boundaries, but does not enter the fenced portion of the site. Potential radiation doses to this receptor accrue from exposure to contaminated creek water and sediments.

Since the duration of this study is within the period of continued SDA institutional controls, public intrusion within the fenced area of the site and alternate uses of the SDA land area are not included in the assessment.

11.2 SITE MODEL

In the context of this QRA, environmental radiation dose assessment is essentially a mathematical simulation of the potential behavior of radioactive materials at the SDA site. Development of a site conceptual model is the first step in this process. The conceptual model includes characterization of the trenches, their contents, radioactive material release mechanisms and threats, and response actions. The conceptual model also includes characterization of the environmental setting in which the trenches are located, potential

transport paths, actual and potential land and water uses, and controls on those uses. Much of this has been done and is described in earlier sections of this report.

Selection or development of a set of mathematical models that collectively represent the site conceptual model is the next step, followed by selection of data required for implementation of the models, and, finally, implementation.

Evaluation of trench contents and potential release mechanisms in earlier sections identified a limited number of release types:

- Flow of trench water through groundwater
- Flow of trench water overflow over land surfaces
- Flow of trench solids and trench water through trench wall breaches
- Ejection of trench solids into air through explosive cap breach

Coordinated consideration of the release types, the environmental setting of the SDA, and the likely radiation exposure scenarios that could occur is necessary to determine information and modeling requirements for dose assessment.

In the environmental setting of the SDA, the first three types of release would introduce radioactive material into nearby small surface streams feeding Buttermilk Creek (Frank's Creek or Erdman Brook) or into Buttermilk Creek directly. NYSERDA controls the property along the small streams and along Buttermilk Creek downstream of any likely points of entry of releases from the SDA to point just a short distance above its confluence with Cattaraugus Creek. It is assumed that NYSERDA control will continue through the 30-year period of interest. Consequently, there would be no permanent inhabitants along the small streams feeding Buttermilk Creek or along Buttermilk upstream of a short reach at its end.

NYSERDA property controls would probably not prevent infrequent and short-duration access by recreational hikers along the streambeds of Buttermilk Creek and the lower reaches of Frank's Creek. As recognized in defining the scope of the QRA (see above), the dose assessment needs to consider that such a hiker would likely receive the highest radiation dose in 1 year from direct radiation from radioactive materials in solids released to the streams. As explained in Section 10, trench solids dilution factors would vary in a reasonably predictable way along these streams, regardless of the quantity of trench solids released. Assuming uniform distributions of trench radionuclides over areas as small as about 300 m², or a 10-meter radius circle (Reference 11.2-1, Figure 7.2), the radioactive material in sediment can be considered to be a semi-infinite slab. In this case, the dose rate from direct radiation would be proportional to the radionuclide concentration in trench solids divided by the dilution factor at the point of interest in the streambed. The dose to a hiker would be the dose rate over the time he spends walking along each section of the stream. Assuming he spends an equal amount of time in each fixed-length interval along his path, his total dose in 1 year would be directly proportional to his total annual hiking time spent in those streambeds, the radionuclide concentration in trench solids, and the inverse of the occupation time-weighted dilution factor along his path. The only source and transport information required for dose assessment is radionuclide concentration in trench solids, the occupation time-weighted dilution factor along the hiker's path.

Water from these small streams near the trenches, from Buttermilk Creek, and from Cattaraugus Creek (which carries Buttermilk Creek outflow to Lake Erie) is not used and is not

likely to be used for drinking water. But there is a small farm occupying land on both sides of Buttermilk Creek near its confluence with Cattaraugus Creek. Also as recognized in defining the scope of the QRA (see above), the receptor likely to receive the highest radiation dose in 1 year from dissolved radioactive materials in stream waters (i.e., from trench water releases) would be a farmer on Buttermilk Creek who could use creek water for crop irrigation and livestock watering. As explained further below, the radiation dose received by such a receptor would be proportional to the time-integrated radionuclide concentration in Buttermilk Creek at the point of water withdrawal. As noted in Section 9, examination of release mechanisms and the flow characteristics of the nearby small streams shows that water flow rates through these paths are small relative to the flow rate of Buttermilk Creek, and need not be considered in determining the ultimate concentration of dissolved radionuclides in Buttermilk Creek, and, therefore, need not be considered in dose assessment. Consequently, the source and transport information required for dose assessment is the quantity of radioactive material introduced into Buttermilk Creek over the duration of release or 1 year, whichever is shorter, and the average flow rate of Buttermilk Creek during the period of release.

Consideration of the last release type, ejection of trench solids into air through explosive breach, led to specification of an additional receptor, because the two previously identified receptors would not likely be the receptors receiving the maximum doses from this scenario. Because the location of this receptor could not be identified without analysis, it was specified somewhat vaguely as a farmer anywhere beyond 0.5 miles from the SDA. It was decided further to integrate the transport and dose assessment for this scenario, because this was a common capability in dose assessment software packages. The information required for atmospheric transport and dose assessment for this case is meteorological data suitable for atmospheric transport analysis and the quantity of radioactive material introduced into the air. The latter is a function of the energy of the explosion, which is also an important determinant of plume rise and atmospheric dispersion.

11.3 DOSE ASSESSMENT METHODOLOGY

Environmental radiation dose assessment is complex primarily because of the need to evaluate mixes of substantial numbers of radionuclides and the need to manage and use large databases associated with them. For most situations, including the one under consideration in this study, this complexity requires the use of computer programs to perform the assessments.

After evaluations of computer model options for calculation of environmental radiation dose, the GENII-V2 package, actually a collection of models, was chosen as the most suitable and most flexible candidate for the requirements of this study. This model package can calculate doses for short-duration and long-duration releases from radioactive materials in soils, radioactive materials released in dissolved form into water bodies, and radioactive materials released to air. Some general understanding how GENII-V2 works is necessary to understand fully how it was applied in this study. A short description of the package's major characteristics follows.

The GENII-V2 software package was developed for the Environmental Protection Agency, Office of Radiation and Indoor Air (References 11.2-1 and 11.2-2). The purpose of the GENII-V2 software package is to provide the capability to perform dose and risk assessments of environmental releases of radionuclides. The software also has the capability of calculating environmental accumulation and radiation doses from surface water, groundwater, and soil media when an input concentration of radionuclide in these media is provided. The components of GENII-V2 have been developed to operate within the Framework for Risk Analysis in Multimedia Environmental Systems (FRAMES), a software platform for construction conceptual

site models and linking software to perform environmental transport and health risk assessments. FRAMES allows the user to choose the most appropriate models to solve a particular simulation problem. The components of GENIIV2 are among available models implemented through FRAMES.

The GENII-V2 software package in the FRAMES environment includes at least one model for each of the following components:

- Source Term Definition
- Atmospheric Transport
- Surface Water Transport
- Exposure Pathways
- Receptor Intake
- Health Impact Estimation
- Selected Report Generation

To perform an analysis, the user selects the components to be included in an analysis, selects models from within those components, provides necessary input data (via the user interfaces), and runs each component module in sequence. Output from upstream modules serves as input to downstream modules. Brief descriptions of GENII models for each of these components follow.

Source Term Definition Module

The radionuclide source term is defined using the source term module provided with the GENII-V2 software package. This module allows the user to define the initial soil concentration (for the near-field exposure module), release rates to the atmosphere (for the atmospheric transport modules), and release rates to surface water (for the surface water modules). The output from the source term modules is written to files designed to couple with downstream components—transport models, exposure models, etc.

Surface Water Transport Module

Radionuclide transport in surface water is evaluated using the GENII-V2 surface water transport module. This module allows the user to define characteristics of the surface water body, and the location of the usage location at which individual may be exposed. Input release rates are used to compute nuclide concentrations in water at the exposure location, averaged over the input period of release.

Atmospheric Transport Modules

The GENII-V2 software package contains five calculational programs for the atmospheric transport component. There are puff- and plume-based programs for both acute and chronic releases. The suite of codes accounts for the transport, diffusion, deposition, depletion, and decay of radionuclides while in the atmosphere. Input to the models is the air release rate from the source term definition module. Meteorological data is accessed through auxiliary data files that include meteorological data from a large number of U.S. weather stations, including Buffalo, NY, used in this analysis for evaluation of the atmospheric transport of release of trench solids to air. The model used in this analysis is the chronic plume module, which uses the sector-averaged, straightline Gaussian plume model.

Exposure Pathways Modules

Three exposure pathway modules are provided in the GENII-V2 software package. The near-field module allows estimation of exposures to an individual in proximity to a contaminated soil source area. The acute exposure component allows evaluation of exposures over a short time period from acute airborne or waterborne releases. The chronic exposure component allows evaluation of exposure from routine releases to air or water. These components are described in more detail below. The near-field module was used in this analysis to calculate the dose to a hiker exposed to radioactive material in trench solids in stream sediments. For reasons discussed below, the chronic exposure module was used to calculate doses from radionuclides released in trench water and radionuclides released in trench solids ejected into the air.

Near-Field Exposure Module

The near-field exposure module may be used to simulate exposure scenarios where the exposed individual comes in direct contact with (e.g., up to the point of living on) the contaminated source. This source may be represented as a contaminated surface layer, a buried layer of waste (deep soil), or a package of buried waste. These compartments are represented by a three-compartment soil model to simulate transfer and loss of radioactive contaminants over time. The user may define initial contamination in one or more of the three compartments. Exposure pathways linked to the near-field model are those associated with contact with soil, suspension of surface soil, and agricultural pathways resulting from crop production in the contaminated layers (surface or deep soil). Input to the near-field module is initial soil concentration (surface soil or deep soil), and/or the initial total activity in the waste package input through the source term definition module. Output from the module is the average exposure media concentrations for each exposure pathway, averaged over the user-defined exposure duration.

Acute Exposure Module (not used in this analysis, but is discussed below as rejected option)

The acute exposure model is used to evaluate exposures following accidental or short-term releases with transport to an exposure location. Transport may be via the atmosphere or surface water; groundwater transport is not considered for acute releases because of the long time periods generally required for transport of contaminants through aquifers. Exposure pathways linked to the acute exposure model are those associated with air exposure (inhalation and external exposure), contact with soil following atmospheric deposition or surface water deposition (irrigation), resuspension of surface soil, agricultural pathways contaminated by airborne or irrigation water deposition, domestic water use (drinking and showering), and recreational water pathways (swimming, boating, and shoreline activities). Exposure to agricultural products is evaluated assuming the deposition to occur at the time of crop harvest. The input to the acute exposure module is air concentrations or water concentrations from the transport modules. Output from the module is the average exposure media concentration for each exposure pathway, averaged over the user-defined exposure duration.

Chronic Exposure Module

The chronic exposure model is used to evaluate exposures over extended periods of media contamination. Transport may be via the atmosphere, surface water, or groundwater media. Exposure pathways linked to the chronic exposure model are those associated with air exposure (inhalation and external exposure), contact with soil following atmospheric deposition

or water deposition (irrigation), resuspension of surface soil, agricultural pathways contaminated by airborne or irrigation water deposition, domestic water use (drinking and showering), and recreational water pathways (swimming, boating, and shoreline activities). Exposure to agricultural products is evaluated assuming that deposition occurs uniformly over annual periods, with deposition rates defined as a function of time from air concentrations from the transport modules. Output from the module is the annual average exposure media concentration for each exposure pathway for the user-defined exposure duration.

Receptor Intake Module

The receptor intake module uses the exposure media concentration values from the exposure pathway module to estimate the intake by the exposed individual(s). The intake is represented as the total activity taken in (via inhalation or ingestion). For external exposure pathways, the result is expressed as the average concentration in the exposure media over the exposure duration, corrected for any appropriate modification factors (e.g., occupancy fraction by the exposed individual). Several user-defined age groups may be used.

Health Impact Module

The health impacts from the receptor intake module are converted to estimates of radiation dose or health impacts by the health impacts module. The user may choose the method for evaluation of health impacts and the endpoint of interest (e.g. radiation dose, cancer incidence, cancer fatality, etc). Results may be calculated and reported by organ or cancer site.

The GENII-V2 options for calculating radiation dose are quite complex and a large amount of radionuclide/pathway/age specific data is required. Options include the calculation of dose and risk using ICRP Publication 26 and 30, calculation of risk using EPA slope factors, and calculation of dose and risk using ICRP Publication 60 and 72, and Federal Guidance Report 13. These data files are included in the GENII-V2 software package, and each is used by the health impacts calculational component. The GENII-V2 health impact component accounts for the decay energies of the implicit progeny in the dose rate factor assigned for the explicit parent radionuclides.

Detailed Model Descriptions

Detailed descriptions of calculations in all of these modules are included in the Software Design Document (Reference 11.2-1) and are not reproduced here. Selection of models and implementation of the methodology is described below.

11.4 METHODOLOGY IMPLEMENTATION

The first step after software package selection was specification of exposure pathways to be evaluated for the various receptor scenarios.

Two exposure pathways were evaluated for the hiker receptor scenario, in which exposure occurs through release of radionuclides in trench solids to streams (Scenarios 4-1 through 4-4):

- Direct exposure to soils (sediments) containing radionuclides
- Incidental ingestion of small quantities of stream sediments

Receptors for the other scenarios were assumed to be resident farmers. Evaluations for release of trench solid materials to air included the following exposure pathways:

- Inhalation
- Direct exposure to soils containing deposited radionuclides
- Consumption of crops containing directly deposited radionuclides and grown in soils containing deposited radionuclides
- Consumption of food products from animals fed crops containing directly deposited radionuclides and grown in soils containing deposited radionuclides

Evaluations for release of trench water to streams included the following exposure pathways:

- Inhalation
- Direct exposure to irrigated soils containing deposited radionuclides
- Incidental direct exposure to radionuclides sorbed onto streambed sediments from water releases
- Consumption of crops containing directly deposited radionuclides and grown in soils containing deposited radionuclides
- Consumption of food products from animals fed crops containing directly deposited radionuclides and grown in soils containing deposited radionuclides

Selection of appropriate exposure models was the next consideration. For the evaluation of dose to a hiker, the near-field model, with concentrations in soils (sediments) specified on input, was the obvious choice. For the other receptor scenarios, some analysis was required. GENII V2 includes both acute and chronic exposure models to calculate doses from both acute and chronic releases, defined as follows:

- **Acute Release:** The release of material to the air or surface water over a brief period, assumed in the models to be on the order of a few hours
- **Chronic Release:** A release of material to the air or surface water that continues essentially uniformly over a long period, taken in the models to be a year

It initially appeared that different models could be needed for different releases. However, sensitivity studies and theoretical considerations demonstrated that the chronic model would be a preferred choice for all scenarios. In the acute model,

$$D = K1(t) * A / Fdil * Fdraw * U * DCF \quad (11.4.1)$$

where

D = Dose, millirem

A = Activity released, Ci

Fdil = Dilution flow in Buttermilk Creek, cfs

Fdraw = Water withdrawal rate from Buttermilk Creek, cfs

U = Receptor media consumption rate (kg/y) or occupation time (h/y)

DCF = Dose conversion factor, millirem/Ci for ingestion and inhalation or millirem/h per Ci/kg for direct exposure to radioactive material in soil

K1(t) = a transfer function from concentration in water withdrawn to concentration in media consumed or concentration in soil, incorporating appropriate units conversion factors

For air inhalation and water ingestion, K1 is not time-dependent, but for other pathways, including direct radiation from radionuclides deposited on soils, it is typically the integral of an exponential removal function.

In the chronic model,

$$D' = K2(t) * A' / Fdil * Fdraw * U * DCF \quad (11.4.2)$$

where

D' = Dose rate, millirem per year

A' = Activity release rate, Ci/y

K2(t) = a transfer function from concentration in water withdrawn to concentration in media consumed or concentration in soil, incorporating appropriate units conversion factors

For air inhalation and water ingestion, K2 is not time-dependent, in which case, K1 = K2 and D and D' are numerically equivalent. For other pathways, K2(t) is typically the solution of a first order- constant rate buildup-exponential removal differential equation, which has the same form as K1(t), above. For processes with short time constants, (either short half-lives or short removal half-times, as in deposition directly on plant material), K1 and K2 are identical and D and D' are numerically equivalent. For long-lived materials deposited on soils and uptake in plants from materials deposited on soil, for example, the situation is not so clean. But sensitivity studies showed that those pathways would not contribute significantly to dose, given the SDA nuclide mix. Consequently, the chronic exposure model was selected for evaluation of all scenarios involving release of trench water and release of trench solids to air.

Buildup and removal dynamics were not a factor in the near-field exposure model used for evaluation of doses from releases of trench solids to streams.

The selection of an atmospheric transport model needed to consider that the receptor location could not be specified. Accordingly, a straightline Gaussian, sector-average dispersion model

was used, but the activity release rate input was multiplied by 16 (the number of sectors) to more closely represent, if only approximately, wind blowing constantly into each sector. Errors introduced by sector-averaging are probably unimportant in routine applications of this model—chronic, long duration releases at a near-constant rate. But they needed more consideration in the application considered here. Sector averaging probably did not introduce much error for mid-range stability classes, because lateral dispersion would be reasonably close to sector widths for these classes. The approach probably overestimated doses for unstable conditions somewhat by confining a plume within a sector when it would actually disperse more widely into other sectors. This approach probably underestimated doses for stable conditions by forcing plume spreading to sector boundaries when actual dispersion would result in less spreading. However, the very large thermal effects from the explosion causing the release also would result in very high plume rises, very slow subsequent downward dispersion in the ambient stable conditions, and, consequently, very low doses, the underestimation of which would be inconsequential for purposes of this QRA. In view of these considerations, the straightline Gaussian, sector-averaged dispersion model was selected for evaluation of atmospheric transport.

Specification of model input parameter values was next in the sequence. For the farmer scenarios, the GENII V2 default set of parameter values was used for dose evaluation. Values are listed in the Software Design Document (Reference 11.2-1). For the hiker scenario, an occupation time of 100 hours per year with no shielding was assumed for the direct exposure pathway, the only important pathway evaluated.

Dose assessment evaluation was structured to produce best point estimate doses normalized as necessary to certain parameter values in a way that permitted using a single GENII V2 case to represent all scenarios within each of the three release/receptor types—trench water releases to streams/Buttermilk Creek farmer, trench solids releases to streams/streambed hiker, and trench solid releases to air/local farmer, location unspecified. For the last situation, there is only one scenario, and the source term information developed in Section 9 was used directly as input to GENII V2, and the calculated dose was not normalized. For the middle case, the dose to the hiker was computed normalized to a dilution factor of 1 by using the concentrations in Table 9.3-1 directly as the source input to GENII V2. For the first case, the source input was structured to produce a dose normalized to a 1 cfs trench water release flow rate, a 1-day duration of release, and a 1 cfs Buttermilk Creek dilution flow rate. This permits use of the result for any combination of values for those three parameters. Examination of the trench water release scenarios as a group revealed that variations in the values of those three parameters constituted the full variation between scenarios. Results are presented and discussed below.

11.5 RESULTS

Results assessment of radiation doses from releases of trench water, releases of trench solids to streams, and releases of trench solids to air are presented and discussed in turn below.

11.5.1 Releases of Trench Water

11.5.1.1 Introduction

The results of the calculation of maximum 1-year dose from radionuclide-bearing trench water are provided below. The receptor assumed for releases of radionuclide-bearing trench water to streams is a farmer on Buttermilk Creek near the confluence with Cattaraugus Creek. Exposure

pathways evaluated include occasional direct exposure to stream sediments containing adsorbed nuclides, consumption of crops irrigated with Buttermilk Creek water, and consumption of food products from animals watered with Buttermilk Creek water and fed crops irrigated with Buttermilk Creek water. Results are presented as maximum 1-year dose normalized to the ratio of trench fluid release rate to Buttermilk Creek dilution flow rate of 1 over the course of the release, and normalized to a release duration of 1 day. Results are normalized to a release period of 1 day and are calculated on the basis that the release period is short relative to 1 year, and that the exposure period—the period of time the receptor is exposed to the release, is 1 year following the release.

11.5.1.2 Point Estimate

Results are provided for two nuclide spectra, as described below.

Poorly Retarded Nuclide Spectrum—Point Estimate

The first nuclide spectrum includes only those trench fluid nuclides not adsorbed or otherwise retarded in transit along groundwater flow paths. These nuclides are H3, C14, I129, and Tc99. The best point estimate dose result is:

$$D = 2.4E2 * FTrFI / FBC * Trel, \text{ where}$$

D is the maximum 1-year dose, millirem

FTrFI is the release flow rate, normally the flow rate of water leaving the trenches. For groundwater, however, it is the flow rate entering surface streams of water containing radionuclide concentrations equivalent, in terms of radionuclide activity release rate, to the flow rate of undiluted trench water. So, for example, FTrFI would be 0.25 cfs for a situation in which a 1 cfs groundwater flow rate into a stream contains radionuclide concentrations only 25% of concentrations in trench fluids. The mass rate output of the groundwater flow / transport model spreadsheets described in Section 6.5 represents FTrFI in cfs.

FTrFI / FBC is the ratio of FTrFI to Buttermilk Creek flow rate (both in the same units) during the course of the release.

Trel is the release time in days.

This nuclide spectrum is used only for groundwater flow / transport models ULTLAT3, ULTVERT, and KRS.

The major nuclide contributor to dose is I-129 through direct consumption of irrigated crops.

All Nuclide Spectrum—Point Estimate

The second nuclide spectrum includes all trench fluid nuclides. The best point estimate dose is:

$$D = 4.8E3 * FTrFI / FBC * Trel,$$

where terms are as defined above.

This nuclide spectrum is used for all other trench fluid releases, including the remaining groundwater flow/transport models and trench overflows. The major nuclide contributors to dose are actinide nuclides through direct consumption of irrigated crops. Direct deposition of radionuclides on vegetation accounted for almost all the calculated dose.

Point estimates of all quantities necessary to compute doses from all trench fluid release scenarios, the expression (FTrFI / FBC*Trel), or its components, are described in Sections 9 and 10.

11.5.1.3 Uncertainties

Significant uncertainties are associated with these normalized dose estimates. The uncertainty distributions recommended for these normalized dose estimates are lognormal, defined as follows:

Poorly-Retarded-Nuclide Spectrum (Distribution designation—DOMRPR)

Median—2.4E2 normalized millirem

2.5%-97.5% range (no truncation)—1.2E2 to 4.8E2

All-Nuclide Spectrum (Distribution designation—DOLRAN)

Median—4.8E3 normalized millirem

2.5%-97.5% range (no truncation)—1.6E3 to 1.4E4

These distributions are based to a considerable extent on judgment in that the major contribution to the distribution is uncertainty in the ICRP dose factors relating activity intake to dose. These distributions do not include uncertainties associated with nuclide concentrations in trench fluid (discussed in Section 9), or uncertainties in time-integrated concentration at the receptor location--uncertainties in dilution during transport, release duration, etc.

11.5.2 Releases of Trench Solids to Streams

11.5.2.1 Introduction

The results of the calculation of maximum 1-year dose from release of radionuclide-bearing trench solids to streams are provided below. The receptor assumed for this release is a hiker in the streambeds of Buttermilk Creek between its confluence with Cattaraugus Creek and the Frank's Creek with Buttermilk Creek, and in the lower reaches of Frank's Creek. Exposure pathways evaluated include direct exposure to stream sediments containing trench solids and inadvertent ingestion of small quantities of stream sediments. Results were calculated for a total exposure time of 100 hours per year to undiluted trench solids as released from the trenches prior to any dilution from uncontaminated soils released to the streams or any dilution from other sediments transported through the streams to Cattaraugus Creek.

11.5.2.2 Point Estimate

Results are provided for three nuclide spectra, each representing one release scenario, as described below.

Local Landslide, Seismic Slope Failure 1, Gully Erosion—Scenarios 4-1 and 4-2

The first nuclide spectrum represents solids releases from Trenches 1/2, Trench 8, and 125 feet of the North ends of Trenches 3, 4, and 5 (Scenarios 4-1 and 4-2). The best point estimate dose result is:

$$D = 2.49E4 / DF$$

D is the maximum 1-year dose, millirem, and DF is the hiking-path-time-weighted average dilution factor for solids released from the trenches (DF>1).

The major nuclide contributor to dose is Cs-137 through direct radiation.

Seismic Slope Failure 2—Scenario 4-3

The second nuclide spectrum represents solids releases from Trenches 1/2, Trench 3, Trench 8, Trench 9, and 250 feet of the North ends of Trenches 4 and 5 (Scenario 4-3). The best point estimate dose result is:

$$D = 2.76E4 / DF$$

D is the maximum 1-year dose, millirem, and DF is the hiking-path-time-weighted average dilution factor for solids released from the trenches (DF>1).

The major nuclide contributor to dose is Cs-137 through direct radiation.

Global Landslide—Scenario 4-4

The third nuclide spectrum represents solids releases from all trenches except Trench 6 and Trench 7 (Scenario 4-4). The best point estimate dose result is:

$$D = 1.95E4 / DF$$

D is the maximum 1-year dose, millirem, and DF is the hiking-path-time-weighted average dilution factor for solids released from the trenches (DF>1).

The major nuclide contributor to dose is Cs-137 through direct radiation.

Point estimates of all dilution factors necessary to compute doses from all trench solid release scenarios are provided in Section 10.

11.5.2.3 Uncertainties

Significant uncertainties are associated with these normalized dose estimates. The uncertainty distributions selected for these normalized dose estimates are uniform, defined as follows:

Local Landslide, Seismic Slope Failure 1, Gully Erosion (Distribution designation—DOSED1)

Mean—2.49E4 normalized millirem

2.5%-97.5% range (no truncation)—1.25E4 to 3.74E4

Seismic Slope Failure 2 (Distribution designation—DOSED2)

Mean—2.76E4 normalized millirem

2.5%-97.5% range (no truncation)—1.38E4 to 4.13E4

Global Landslide (Distribution designation—DOSEDG)

Mean—1.95E4 normalized millirem

2.5%-97.5% range (no truncation)—9.75E3 to 2.93E4

These distributions are based on an assessment that, given the distribution of nuclides in sediments, the major contribution to uncertainty is time of exposure. The range represents exposure time from 50 to 150 hours over the course of a year following release. These distributions do not include uncertainties associated with nuclide concentrations in trench solids (discussed in Section 9).

11.5.3 Releases of Trench Solids to Air

11.5.3.1 Introduction

The results of the calculation of maximum 1-year dose from radionuclide-bearing air releases are provided below. The receptor assumed for releases of radionuclide-bearing trench water to air is a farmer anywhere beyond 0.5 miles from the SDA in any direction.

Results are presented as maximum 1-year dose from the radioactive material release associated with the explosion of 100,000 lbs of aviation fuel directly over exposed SDA trench materials. Results are calculated for the best point estimate for the inventory of radionuclides in trench solids.

Results are not linear with quantity of fuel exploded. The results specifically evaluated for 100,000 lbs conservatively represent results for any smaller quantity of fuel exploded. The quantity of 100,000 lbs of aviation fuel is considered to be at the higher end of the range of likelihood of explosion capacity from the range of potential threats.

11.5.3.2 Point Estimate

The best point estimate dose result is:

$D = 12.2$, where

D is the maximum 1-year dose, millirem

The major contributor to dose is inhalation of Pu-238.

11.5.3.3 Uncertainties

Significant uncertainties are associated with this dose estimate. The uncertainty distribution selected for this dose estimate (Distribution designation—DOSEA) is lognormal, defined as follows:

Median—12.2 millirem

2.5%-97.5% range (no truncation)—4.1 to 36.5

This distribution is based to a considerable extent on judgment in that the major contribution to the distribution is uncertainty in the ICRP dose factors relating activity inhalation intake to dose. This distribution does not include uncertainties associated with nuclide concentrations in trench solids (discussed in Section 9).

11.6 ADDITIONAL PARAMETERS

In describing the calculation of normalized doses during the dose assessment process, consideration of appropriate values for the excluded parameters was not addressed. Those parameters related to release characteristics are discussed in Section 9. The two not yet described are dilution flows for trench water released to streams and dilution factors for trench solids released to streams.

With respect to dilution factors for trench solids, Table 10.5-2 contains data necessary to compute dilution factors for dilution processes operating during the destabilization of the trenches prior to introduction of any trench materials into streams. Table 10.5-3 contains data necessary to calculated dilution factors for dilution processes within streams.

The first dilution factor can be computed by dividing the total non-trench (dilution) solid mass for the affected trenches by the total affected mass of trench solids (waste and non-waste). (Tabulations of radionuclide concentrations in trench solids already account for the dilution by non-waste solids in the trenches.) The dilution factor computed in this way for Case 2 in Table 10.5-2, which corresponds to Release Scenarios 4-1 and 4-2, is 6.7. The corresponding dilution factor computed in this way for Case 1 in Table 10.5-2, which corresponds to Release Scenario 4-3, is 11.0. No dilution factor is tabulated for Case 4 in Table 10.5-2, which corresponds to Release Scenario 4-4, but it can be presumed to be very large.

The second dilution factor, the within-stream dilution, can be calculated from data in Table 10.5-3. Examination of table entries for "SDA (%)," the percent of SDA trench solids in deposited solids in a given reach for a variety of precipitation events, reveals a dilution pattern. Relatively little dilution occurs with some likelihood in the small streams. But fairly substantial dilution, almost always more than a factor of 10, and usually closer to a value of 100, occurs in Buttermilk Creek. That table also allows computation of hiker path lengths in Buttermilk Creek and Frank's Creek. Assuming the path includes the lower two reaches of Frank's Creek, and all of the tabulated reaches of Buttermilk Creek, the total path is 15,200 feet, of which 2,100 is in Frank's Creek and 13,100 feet is in Buttermilk Creek. If one assumes a dilution factor of 2 for Frank's Creek and 20 for Buttermilk Creek, both conservative representations, the path length-weighted dilution factor for the creek system as a whole is 8.8 for all Release Mechanism 4 releases.

Combining near-trench and in-stream dilution leads to a total dilution factor of 59 for Release Scenarios 4-1 and 4-2 and 97 for Release Scenario 4-3. An overall dilution factor for Release Scenario 4-4 would be difficult to derive. But it would probably exceed 1,000, which was selected as a reasonable value for this study.

With respect to dilution flows for release of trench water to streams, for all but the Release Mechanism 3 (trench overflow) scenarios, Buttermilk Creek can be assumed to be flowing at its base flow condition, 52.6 cfs (see Section 10). The trench overflow scenarios, however, all are related to precipitation events of various intensities, which would increase flows in Buttermilk Creek to levels far above the base flow rate, as discussed in Section 8.4.

11.7 REFERENCES

- 11.1-1 "ICRP Publication 30, Part 1, Limits for Intakes of Radionuclides by Workers", International Commission on Radiological Protection (ICRP), *Annals of the ICRP*, Vol. 2, No. 3/4, Pergamon Press, New York, New York 1979
- 11.1-2 "ICRP Publication 30, Supplement to Part 1, Limits for Intakes of Radionuclides by Workers", International Commission on Radiological Protection (ICRP), *Annals of the ICRP*, Vol. 3, No. 1-4. Pergamon Press, New York, New York 1979
- 11.1-3 "ICRP Publication 30, Supplement to Part 1, Limits for Intakes of Radionuclides by Workers", International Commission on Radiological Protection (ICRP), *Annals of the ICRP*, Vol. 3, No. 1-4. Pergamon Press, New York, New York, 1979
- 11.1-4 "ICRP Publication 30, Part 2, Limits for Intakes of Radionuclides by Workers", International Commission on Radiological Protection (ICRP), *Annals of the ICRP*, Vol. 4, No. 3/4, Pergamon Press, New York, New York, 1980
- 11.1-5 "ICRP Publication 30, Supplement to Part 2, Limits for Intakes of Radionuclides by Workers", International Commission on Radiological Protection (ICRP), *Annals of the ICRP*, Vol. 5, No. 1-6, Pergamon Press, New York, New York, 1981
- 11.1-6 "ICRP Publication 30, Part 3 Including Addendum to Parts 1 and 2, Limits for Intakes of Radionuclides by Workers", International Commission on Radiological Protection (ICRP), *Annals of the ICRP*, Vol. 6, No. 2/3, Pergamon Press, New York, New York, 1981
- 11.1-7 "ICRP Publication 30, Supplement A to Part 3, Limits for Intakes of Radionuclides by Workers", International Commission on Radiological Protection (ICRP), *Annals of the ICRP*, Vol. 7, No. 1-3, Pergamon Press, New York, New York, 1982
- 11.1-8 "ICRP Publication 30, Supplement B to Part 3 Including Addendum to Supplements to Parts 1 and 2, Limits for Intakes of Radionuclides by Workers", International Commission on Radiological Protection (ICRP), *Annals of the ICRP*, Vol. 8, No. 1-3, Pergamon Press, New York, New York, 1982
- 11.2-1 "GENII Version 2 Software Design Document", Napier, B.A., Strenge, D.L., Ramsdell, J.V. Jr., Eslinger, P.W., Fosmire, C., Pacific Northwest National Laboratory, PNNL-14584, Rev. 2b, 2008

- 11.2-2 "GENII Version 2 Users' Guide", Napier, B.A., Pacific Northwest National Laboratory, PNNL-14583, Rev. 2b, 2008
- 11.2-3 "Concepts of a Framework for Risk Analysis In Multimedia Environmental Systems (FRAMES)", Whelan, G., Castleton, K. J., Buck, J. W., Gelston, G. M., Hoopes, B. L., Pelton, M. A., Strenge, D. L., and Kickert, R. N., PNNL-11748. Pacific Northwest National Laboratory, Richland WA, 1997

SECTION 12

SCENARIO QUANTIFICATION

Section 8 describes the event scenarios that define the logical framework for analysis and quantification of the SDA risk. The risk from each scenario is determined by the following functional elements.

- The frequency of disruptive events or natural processes that cause a release of radioactive materials from the SDA trenches
- The physical form, quantity, and radionuclide content of the material that is released during each scenario
- Distribution, dilution, and deposition of the released materials throughout the environment surrounding the SDA site
- Public exposure to the distributed material, and the accumulated radiation dose from that exposure

Of course, our understanding of the risk must also account for the available information, technical knowledge, and associated uncertainties about each of these elements.

Sections 8 through 11 summarize the analyses that were performed to evaluate each functional risk element. This section describes the computational format for assembling and quantifying the frequency of each scenario and its consequences.

Probability distributions for each major input parameter were developed in Excel spreadsheets. The Crystal Ball software (Reference 12-1) was used to quantify the risk equations. Probability distributions for the frequency of each scenario and its corresponding dose were derived from analyses that used 10,000 Monte Carlo samples.

12.1 RISK FROM LIQUID RELEASES

Release Mechanisms 1, 2, 3, and 4 involve liquid releases from the waste trenches into the adjacent streams. The risk from each liquid release scenario is quantified by the frequency of that scenario and the dose from the radioactive liquid in the stream water.

$$R(X) = \text{Frequency of Release Scenario X (release event / year)}$$

and

$$\text{Dose}(X) = CW_x * (FR_x / FD_x) * T_x * K1 * K2 * K3 \quad (12.1.1)$$

where

$$\text{Dose}(X) = \text{Maximum dose in any 1-year period following Release Scenario X, summed over all radionuclides (mrem)}$$

- CW_x = Concentration of radionuclide in trench liquid for Release Scenario X (Curies / cubic foot)
 FR_x = Trench water release flow rate, averaged over the release duration for Scenario X (cubic feet / second)
 FD_x = Dilution flow rate for Scenario X at receptor location (cubic feet / second)
 T_x = Release duration for Scenario X (days)
 $K1$ = Dose conversion factor, per radionuclide (mrem / Curie intake)
 $K2$ = Water withdrawal rate at receptor location (cubic feet / day)
 $K3$ = Curie intake in 1 year per Curie withdrawn (dimensionless)

and

$$CW_x = (CS_x / KD) * K4$$

where

- CS_x = Concentration of radionuclide in trench solids for Release Scenario X (Curies / gram)
 KD = Trench solid / liquid equilibrium distribution ratio [(Curies / gram in solids) / (Curies/ mL in liquid)]
 $K4$ = Units conversion, 28300 mL / cubic foot

So, in terms of the trench solid waste radionuclide concentration:

$$\text{Dose}(X) = (CS_x / KD) * K4 * (FR_x / FD_x) * T_x * K1 * K2 * K3 \quad (12.1.2)$$

For computational efficiency, summations over the released radionuclide spectrum of the quantity $[(CS_x / KD) * K1 * K2 * K3 * K4]$ were calculated using best-estimate values for CS_x , KD , $K1$, $K2$, $K3$, and $K4$. Uncertainties in CS_x , KD , and $(K1 * K2 * K3 * K4)$ were quantified by applying normalized probability distributions $M1$ for CS_x , $M2$ for KD , and $M3$ for $(K1 * K2 * K3 * K4)$. This approach is justified because the quantities CS_x , KD , and $(K1 * K2 * K3 * K4)$ are probabilistically independent, and dose is a linear function of each. Incorporating these efficiencies leads to the following equation for dose:

$$\text{Dose}(X) = (M1 / M2) * (FR_x / FD_x) * T_x * [M3 * (CS_x / KD) * K1 * K2 * K3 * K4] \quad (12.1.3)$$

where

- $M1$ = Normalized probability distribution for the uncertainty in the average concentration of radionuclide in trench solids, CS (dimensionless)

M2 = Normalized probability distribution for nuclide-concentration-independent uncertainty in the value of KD (dimensionless)

M3 = Normalized probability distribution for nuclide-concentration-independent uncertainty in the value of (K1 * K2 * K3 * K4) (dimensionless)

The uncertainty distribution $[M3 * (CS_x / KD) * K1 * K2 * K3 * K4]$ was computed prior to final integration, as was the distribution (M1 / M2).

Table 12-1 lists the input parameters, uncertainty distributions, and scalar quantities that were used to quantify the frequency of each liquid release scenario in Release Mechanisms 1, 2, 3, and 4, and its corresponding dose according to Equation (12.1.3).

The scenario numbers in Table 12-1 correspond to the successive release scenarios that are described in Section 8. For example, Scenario 1–1 is the first scenario for Release Mechanism 1, and it is described in Section 8.2.3.1 (i.e., releases via lateral groundwater flow through the Unweathered Lavery Till, with initially high water levels in the trenches).

- The frequency (R) of Scenario 1–1 is the product of the following factors:
 - One release through this pathway during the 30-year period of this risk assessment
 - 0.12% probability that the trench levels are high
- The dose from the releases during Scenario 1–1 is the product of the following factors:
 - Normalized uncertainty for trench solids and liquid radionuclide concentrations (M1 / M2, probability distribution CSDIKD)
 - Release flow rate (FR, probability distribution ULTLAT1), divided by the stream dilution flow rate (FD, Buttermilk Creek baseline flow)
 - Release duration (T, probability distribution TDETM1)
 - Integrated dose from all released trench liquid radionuclides $[M3 * (CS_x / KD) * K1 * K2 * K3 * K4]$, probability distribution DOLRAN]

12.2 RISK FROM SOLIDS RELEASES

Release Mechanism 4 involves direct relocation of solid waste materials and soil from the breached trenches into the adjacent streams. The risk from each solids release scenario is quantified by the frequency of that scenario and the dose from the radioactive sediments that are deposited along the stream beds.

$R(X)$ = Frequency of Release Scenario X (release event / year)

and

$Dose(X) = (CS_x / F_x) * D * K$ (12.2.1)

where

Dose(X) = Maximum dose in any 1-year period following Release Scenario X, summed over all radionuclides (mrem)

CS_x = Concentration of radionuclide in trench solids for Release Scenario X (Curies / gram)

F_x = Occupation time-weighted dilution factor (F_x > 1) from mixing with nuclide-free solids during release, and mixing with other nuclide-free solids during distribution of solids mixture through the stream system, over the length of the receptor's stream bed hiking path, for Release Scenario X (dimensionless)

D = Hours over the course of 1 year a receptor spends in stream bed, hiking in the vicinity of contaminated sediments (exposure time) (hours / year)

K = One-year dose conversion factor, per radionuclide [(mrem in year) per (hours / year) per (Curies / gram)]

For computational efficiency, summations over the released radionuclide spectrum of the quantity (CS_x * D * K) were calculated using best-estimate values for CS_x, D, and K. Uncertainties in CS_x and D were quantified by applying normalized probability distributions M1 for CS_x and M4 for D. This approach is justified because the quantities CS_x and D are probabilistically independent, and dose is a linear function of each. Uncertainty associated with K is negligibly small relative to uncertainties in the other parameters. Incorporating these efficiencies leads to the following equation for dose:

$$\text{Dose}(X) = (M1 / F_x) * (M4 * CS_x * D * K) \quad (12.2.2)$$

where

M1 = Normalized probability distribution for the uncertainty in the average concentration of radionuclide in trench solids, CS (dimensionless)

M4 = Normalized probability distribution for nuclide-concentration-independent uncertainty in the value of D (dimensionless)

The uncertainty distribution (M4 * CS_x * D * K) was computed prior to final integration.

Table 12-1 lists the input parameters, uncertainty distributions, and scalar quantities that were used to quantify the frequency of each solids release scenario in Release Mechanism 4, and its corresponding dose according to Equation (12.2.2).

For example, Scenario 4-1 is the first solids release scenario for Release Mechanism 4. The threat conditions for this scenario are described in Section 8.5.3.1 (i.e., seismic-induced slope failures) and Section 8.5.3.2 (i.e., localized landslides). Both slope failure conditions result in the same solid material releases from the waste trenches (i.e., from Trenches 1/2, Trench 8, and 125 feet of the north ends of Trenches 3, 4, and 5). Therefore, the threat frequencies are combined for quantification of the risk from these slope failures.

- The frequency (R) of Scenario 4–1 is the sum of the following contributors:
 - Seismic-induced slope damage condition 1 (probability distribution SSLOD1)
 - Localized landslides (probability distribution LOCALS)
- The dose from the releases during Scenario 4–1 is the product of the following factors:
 - Normalized uncertainty for trench solids radionuclide concentrations (M1, probability distribution CS)
 - Reciprocal of the trench soils and stream sediment dilution factor (1 / F, composite factor for amount of material in these trenches, solids transport in streams, and sediment deposition along stream beds)
 - Integrated dose from exposure to deposited sediments (M4 * CS_x * D * K, probability distribution DOSED1)

12.3 RISK FROM AIRBORNE RELEASES

Release Mechanism 5 involves extensive physical disruption of the SDA site and airborne releases from the waste trenches. The risk from each airborne activity release scenario is quantified by the frequency of that scenario and the dose from the radioactive materials that are released into the atmosphere.

R(X) = Frequency of Release Scenario X (release event / year)

and

$$\text{Dose}(X) = \text{CS}_x * K \quad (12.3.1)$$

where

Dose(X) = Maximum dose in any 1-year period following Release Scenario X, summed over all radionuclides (mrem)

CS_x = Concentration of radionuclide in trench solids for Release Scenario X (Curies / gram)

K = One-year dose conversion factor, per radionuclide [(mrem in year) per (Curies / gram in trench solids)]

For computational efficiency, summations over the released radionuclide spectrum of the quantity (CS_x * K) were calculated using best-estimate values for CS_x and K. Uncertainties in CS_x and K were quantified by applying normalized probability distributions M1 for CS_x and M3 for K. This approach is justified because the quantities CS_x and K are probabilistically independent, and dose is a linear function of each. Incorporating these efficiencies leads to the following equation for dose:

$$\text{Dose}(X) = M1 * (M3 * \text{CS}_x * K) \quad (12.3.2)$$

where

M1 = Normalized probability distribution for the uncertainty in the average concentration of radionuclide in trench solids, CS (dimensionless)

M3 = Normalized probability distribution for nuclide-concentration-independent uncertainty in the value of K (dimensionless)

The uncertainty distribution ($M3 * CS_x * K$) was computed prior to final integration.

Table 12-1 lists the input uncertainty distributions that were used to quantify the frequency of airborne activity release Scenario 5–1 in Release Mechanism 5, and its corresponding dose according to Equation (12.3.2). The threat conditions for this scenario are described in Section 8.6.3. Quantification of the risk from these threats is simplified by assuming that aircraft crashes and meteorite impacts result in the same airborne material releases from the waste trenches. Therefore, the threat frequencies are combined for the risk quantification process.

- The frequency (R) of Scenario 5–1 is the sum of the following contributors:
 - Commercial aircraft crashes (probability distribution COMMAC)
 - Military aircraft crashes (probability distribution MILIAC)
 - Meteorite impacts (probability distribution METEOR)

- The dose from the releases during Scenario 5–1 is the product of the following factors:
 - Normalized uncertainty for trench solids radionuclide concentrations (M1, probability distribution CS)
 - Integrated dose from exposure to airborne activity ($M3 * CS_x * K$, probability distribution DOSEA)

12.4 REFERENCES

12-1. Crystal Ball 7 Professional, Oracle USA, Denver, Colorado, 2008

Table 12-1. SDA Risk Scenario Quantification Parameters				
Scenario	Report Section	Release	General Model Parameter	Derivation / Detailed Parameter
1 – 1	8.2.3.1	Liquid	R	$(0.0012) * (1 / 30)$
			M1 / M2	CSDIKD
			FR	ULTLAT1
			FD	52.6 cfs
			T	TDEMI
			$M3 * (CS_x / KD) * K1 * K2 * K3 * K4$	DOLRAN
1 – 2	8.2.3.2	Liquid	R	$(0.0137) * (1 / 30)$
			M1 / M2	CSDIKD
			FR	ULTLAT2
			FD	52.6 cfs
			T	TDEMI
			$M3 * (CS_x / KD) * K1 * K2 * K3 * K4$	DOLRAN
1 – 3	8.2.3.3	Liquid	R	$(0.9351) * (1 / 30)$
			M1 / M2	CSDIKD
			FR	ULTLAT3
			FD	52.6 cfs
			T	TDEMI
			$M3 * (CS_x / KD) * K1 * K2 * K3 * K4$	DOLRPR
1 – 4	8.2.3.4	Liquid	R	$(1 / 30)$
			M1 / M2	CSDIKD
			FR	ULTKRS
			FD	52.6 cfs
			T	TDEMI
			$M3 * (CS_x / KD) * K1 * K2 * K3 * K4$	DOLRPR

Table 12-1. SDA Risk Scenario Quantification Parameters				
Scenario	Report Section	Release	General Model Parameter	Derivation / Detailed Parameter
2 – 1	8.3.3	Liquid	R	$(0.0012) * (1 / 30)$
			M1 / M2	CSDIKD
			FR	WLTLAT
			FD	52.6 cfs
			T	TDEMI
			$M3 * (CS_x / KD) * K1 * K2 * K3 * K4$	DOLRAN
3 – 1	8.4.3.1	Liquid	R	$0.0012 * GEOMUI * IPRECF$
			M1 / M2	CSDIKD
			FR / FD	FRFD31
			T	2 days
			$M3 * (CS_x / KD) * K1 * K2 * K3 * K4$	DOLRAN
3 – 2	8.4.3.1	Liquid	R	$0.0012 * IWITOR$
			M1 / M2	CSDIKD
			FR / FD	FRFD32
			T	1 day
			$M3 * (CS_x / KD) * K1 * K2 * K3 * K4$	DOLRAN
3 – 3	8.4.3.1	Liquid	R	$0.0012 * GEOMUD * IPRE1$
			M1 / M2	CSDIKD
			FR / FD	FRFD33
			T	14 days
			$M3 * (CS_x / KD) * K1 * K2 * K3 * K4$	DOLRAN

Table 12-1. SDA Risk Scenario Quantification Parameters				
Scenario	Report Section	Release	General Model Parameter	Derivation / Detailed Parameter
3 – 4	8.4.3.2	Liquid	R	0.0137 * GEOMUI * IPRE9
			M1 / M2	CSDIKD
			FR / FD	FRFD34
			T	14 days
			M3 * (CS _x / KD) * K1 * K2 * K3 * K4	DOLRAN
3 – 5	8.4.3.2	Liquid	R	0.0137 * IWITOR * WSPR9
			M1 / M2	CSDIKD
			FR / FD	FRFD35
			T	14 days
			M3 * (CS _x / KD) * K1 * K2 * K3 * K4	DOLRAN
3 – 6	8.4.3.2	Liquid	R	0.0137 * GEOMUD * IPRE9
			M1 / M2	CSDIKD
			FR / FD	FRFD36
			T	14 days
			M3 * (CS _x / KD) * K1 * K2 * K3 * K4	DOLRAN
3 – 7	8.4.3.3	Liquid	R	0.9851 * GEOMUI * IPRE25
			M1 / M2	CSDIKD
			FR / FD	FRFD37
			T	14 days
			M3 * (CS _x / KD) * K1 * K2 * K3 * K4	DOLRAN

Table 12-1. SDA Risk Scenario Quantification Parameters				
Scenario	Report Section	Release	General Model Parameter	Derivation / Detailed Parameter
3 – 8	8.4.3.3	Liquid	R	0.9851 * IWITOR * WSPR25
			M1 / M2	CSDIKD
			FR / FD	FRFD38
			T	14 days
			M3 * (CS _x / KD) * K1 * K2 * K3 * K4	DOLRAN
3 – 9	8.4.3.3	Liquid	R	0.9851 * GEOMUD * IPRE25
			M1 / M2	CSDIKD
			FR / FD	FRFD39
			T	14 days
			M3 * (CS _x / KD) * K1 * K2 * K3 * K4	DOLRAN
4 – 1	8.5.3.1, 8.5.3.2	Solid	R	SSLOD1 + LOCALS
			M1	CS
			F	59
			M4 * CS * D * K	DOSED1
4 – 1a	8.5.3.1, 8.5.3.2	Liquid	R	0.0012 * (SSLOD1 + LOCALS)
			M1 / M2	CSDIKD
			FR	2.6 cfs
			FD	52.6 cfs
			T	2 days
			M3 * (CS _x / KD) * K1 * K2 * K3 * K4	DOLRAN

Table 12-1. SDA Risk Scenario Quantification Parameters				
Scenario	Report Section	Release	General Model Parameter	Derivation / Detailed Parameter
4 – 1b	8.5.3.1, 8.5.3.2	Liquid	R	0.0137 * (SSLOD1 + LOCALS)
			M1 / M2	CSDIKD
			FR	1.25 cfs
			FD	52.6 cfs
			T	2 days
			M3 * (CS _x / KD) * K1 * K2 * K3 * K4	DOLRAN
4 – 1c	8.5.3.1, 8.5.3.2	Liquid	R	0.9851 * (SSLOD1 + LOCALS)
			M1 / M2	CSDIKD
			FR	0.60 cfs
			FD	52.6 cfs
			T	2 days
			M3 * (CS _x / KD) * K1 * K2 * K3 * K4	DOLRAN
4 – 2	8.5.3.3	Solid	R	GULLER * GEOMUA
			M1	CS
			F	59
			M4 * CS * D * K	DOSED1
4 – 2a	8.5.3.3	Liquid	R	0.0012 * GULLER * GEOMUA
			M1 / M2	CSDIKD
			FR	2.6 cfs
			FD	52.6 cfs
			T	2 days
			M3 * (CS _x / KD) * K1 * K2 * K3 * K4	DOLRAN

Table 12-1. SDA Risk Scenario Quantification Parameters				
Scenario	Report Section	Release	General Model Parameter	Derivation / Detailed Parameter
4 – 2b	8.5.3.3	Liquid	R	0.0137 * GULLER * GEOMUA
			M1 / M2	CSDIKD
			FR	1.25 cfs
			FD	52.6 cfs
			T	2 days
			M3 * (CS _x / KD) * K1 * K2 * K3 * K4	DOLRAN
4 – 2c	8.5.3.3	Liquid	R	0.9851 * GULLER * GEOMUA
			M1 / M2	CSDIKD
			FR	0.60 cfs
			FD	52.6 cfs
			T	2 days
			M3 * (CS _x / KD) * K1 * K2 * K3 * K4	DOLRAN
4 – 3	8.5.3.1	Solid	R	SSLOD2
			M1	CS
			F	97
			M4 * CS * D * K	DOSED2
4 – 3a	8.5.3.1	Liquid	R	0.0012 * SSLOD2
			M1 / M2	CSDIKD
			FR	3.1 cfs
			FD	52.6 cfs
			T	2 days
			M3 * (CS _x / KD) * K1 * K2 * K3 * K4	DOLRAN

Table 12-1. SDA Risk Scenario Quantification Parameters				
Scenario	Report Section	Release	General Model Parameter	Derivation / Detailed Parameter
4 – 3b	8.5.3.1	Liquid	R	0.0137 * SSLOD2
			M1 / M2	CSDIKD
			FR	1.5 cfs
			FD	52.6 cfs
			T	2 days
			M3 * (CS _x / KD) * K1 * K2 * K3 * K4	DOLRAN
4 – 3c	8.5.3.1	Liquid	R	0.9851 * SSLOD2
			M1 / M2	CSDIKD
			FR	0.65 cfs
			FD	52.6 cfs
			T	2 days
			M3 * (CS _x / KD) * K1 * K2 * K3 * K4	DOLRAN
4 – 4	8.5.3.2	Solid	R	GLOBLS
			M1	CS
			F	1000
			M4 * CS * D * K	DOSEDG
4 – 4a	8.5.3.2	Liquid	R	0.0012 * GLOBLS
			M1 / M2	CSDIKD
			FR	10.7 cfs
			FD	52.6 cfs
			T	1 day
			M3 * (CS _x / KD) * K1 * K2 * K3 * K4	DOLRAN

Table 12-1. SDA Risk Scenario Quantification Parameters				
Scenario	Report Section	Release	General Model Parameter	Derivation / Detailed Parameter
4 – 4b	8.5.3.2	Liquid	R	0.0137 * GLOBLS
			M1 / M2	CSDIKD
			FR	6.6 cfs
			FD	52.6 cfs
			T	1 day
			$M3 * (CS_x / KD) * K1 * K2 * K3 * K4$	DOLRAN
4 – 4c	8.5.3.2	Liquid	R	0.9851 * GLOBLS
			M1 / M2	CSDIKD
			FR	2.8 cfs
			FD	52.6 cfs
			T	1 day
			$M3 * (CS_x / KD) * K1 * K2 * K3 * K4$	DOLRAN
5 – 1	8.6.3	Airborne	R	COMMAC + MILIAC + METEOR
			M1	CS
			$M3 * CS * K$	DOSEA
<p>Notes:</p> <p>The FD value of 52.6 cubic feet / second is the baseline flow rate in Buttermilk Creek under normal environmental conditions.</p> <p>Values for FR in Release Mechanism 4 are average liquid release rates, derived from the total volume of trench fluid that is released over the scenario duration.</p> <p>Values for F in Release Mechanism 4 are composite dilution factors for the amount of waste material and soil in the breached trenches, solids transport in streams, and sediment deposition along stream beds.</p>				

SECTION 13

SUMMARY OF RESULTS

This section presents the results from the SDA risk assessment and describes the most important contributors to the site risk.

13.1 RISK FROM THE SDA

This study evaluates the risk from continued operation of the SDA for the next 30 years with its current physical and administrative controls. The threat analyses have examined a broad spectrum of disruptive events and nominal processes that could cause a release of radioactive materials from the waste trenches, with the exception of threats posed by intentional acts of destruction, war, terrorism, or sabotage. The radionuclide release and transport analyses account for distribution, dilution, and deposition of solid, liquid, and airborne contaminants throughout the environment surrounding the SDA site. The dose analyses evaluate consequential radiation exposures to a resident farmer near the confluence of Buttermilk Creek and Cattaraugus Creek, and to a transient hiker / hunter who traverses areas along Buttermilk Creek and the lower reaches of Frank's Creek. Consequences for this risk assessment are measured by the total effective dose equivalent to all receptors, quantified in terms of millirem (mrem) dose in 1 year.

13.1.1 SDA Risk Curves and their Interpretation

Figure 13.1-1 shows the integrated risk curves for the SDA site, displayed in the "frequency of exceedance" format described in Section 2. The following examples illustrate how these curves are interpreted.

Frequency of Dose Exceeding 0.1 mrem in 1 Year

This result is obtained by taking a vertical "slice" through Figure 13.1-1 at the dose value of $1.0\text{E}-01$ mrem in 1 year. Figure 13.1-2 shows that "slice", displayed in the "probability density" format described in Section 2.

The mean total frequency of all threats that cause radioactive material releases from the SDA site which result in a total effective dose to all receptors of 0.1 mrem in 1 year, or more, is approximately $6.96\text{E}-03$ event per year (i.e., one event in 144 years). There is equal probability that the release frequency for this dose is greater than, or less than, the median value of approximately $6.59\text{E}-03$ event per year (i.e., one event in 152 years). We are 90% confident that the release frequency is between $6.42\text{E}-03$ event per year and $7.80\text{E}-03$ event per year (i.e., between one event in 156 years and one event in 128 years). Since the mean value is the "expected" frequency of these releases, we do not "expect" to have a release that results in a dose of 0.1 mrem in 1 year, or more, during the next 30 years of SDA operation. However, Figure 13.1-2 shows that the long low-probability "tail" of the uncertainty distribution extends far beyond the 95th probability percentile. The full uncertainty results include approximately 1% probability that the frequency of these releases may exceed $3.20\text{E}-02$ event per year. Thus, a complete accounting for the uncertainty in the risk curves concludes that there is approximately 1% probability that this type of release could occur once in 30 years.

Frequency of Dose Exceeding 100 mrem in 1 Year

This result is similarly obtained by taking a vertical "slice" through Figure 13.1-1 at the dose value of $1.0\text{E}+02$ mrem in 1 year. Figure 13.1-3 shows that "slice".

The mean total frequency of all threats that cause radioactive material releases from the SDA site which result in a total effective dose to all receptors of 100 mrem in 1 year, or more, is approximately $5.09\text{E}-04$ event per year (i.e., one event in 1,965 years). There is equal probability that the release frequency for this dose is greater than, or less than, the median value of approximately $4.75\text{E}-04$ event per year (i.e., one event in 2,105 years). We are 90% confident that the release frequency is between $3.91\text{E}-04$ event per year and $6.38\text{E}-04$ event per year (i.e., between one event in 2,558 years and one event in 1,567 years). The QRA results confirm that a release which results in a dose of 100 mrem in 1 year, or more, is extremely unlikely during the next 30 years of SDA operation.

Dose from Releases Occurring Once in 1,000 Years

This result is obtained by taking a horizontal "slice" through Figure 13.1-1 at the release frequency value of $1.0\text{E}-03$ event per year. Figure 13.1-4 shows that horizontal "slice", displayed in the "probability density" format.

The mean consequence to all receptors from all threats that cause a release of radioactive material from the SDA site at a frequency of one event in 1,000 years is a total effective dose of approximately 19 mrem in 1 year. There is equal probability that the consequences from these releases are greater than, or less than, the median value of approximately 14 mrem in one year. We are 90% confident that these events result in doses between 10 mrem in 1 year and 31 mrem in 1 year. However, Figure 13.1-4 shows that the uncertainty in these doses is very skewed. For example, the 99th probability percentile of the uncertainty distribution corresponds to a dose of approximately 87 mrem in 1 year. This means that we are 99% confident that these events result in doses of less than 87 mrem in 1 year, but there is 1% probability that the doses may exceed 87 mrem. The upper end "tail" of the uncertainty distribution extends to a maximum dose of approximately 200 mrem in 1 year.

Figure 13.1-5 is an excerpt from Figure 13.1-1, with an expanded scale that focuses on the dose range from 10 to 1000 mrem in 1 year.

Figure 13.1-6 displays the risk results in terms of the number of release events that occur during the 30-year operating period that is covered by the scope of this risk assessment. It is obtained by multiplying the frequency scale in Figure 13.1-1 by 30 years. For example, the maximum value of the y-axis scale corresponds to 1 event that results in a release of radioactive material from the SDA during the next 30 years. Figure 13.1-6 shows that it is not likely that a release will occur during the next 30 years which results in a dose that exceeds 0.1 mrem in 1 year. (The 95th percentile of the uncertainty distribution corresponds to approximately 0.23 event in 30 years at the dose level of 0.1 mrem in 1 year.) Figure 13.1-6 also clearly shows that it is very unlikely that a release will occur during the next 30 years that results in a 1-year dose of 100 mrem, or more. (The 95th percentile of the uncertainty distribution corresponds to approximately 0.02 event in 30 years at the dose level of 100 mrem in 1 year.)

Figure 13.1-7 is an excerpt from Figure 13.1-6, with an expanded scale that focuses on the dose range from 10 to 1000 mrem in 1 year.

13.1.2 Conclusions and General Observations

Title 10 of the Code of Federal Regulations, Part 20 (10CFR20), Subpart D, specifies "Radiation Dose Limits for Individual Members of the Public". In particular, Section 20.1301 states:

§ 20.1301 Dose limits for individual members of the public.

(a) Each licensee shall conduct operations so that —

(1) The total effective dose equivalent to individual members of the public from the licensed operation does not exceed 0.1 rem (1 mSv) in a year, exclusive of the dose contributions from background radiation, from any administration the individual has received, from exposure to individuals administered radioactive material and released under § 35.75, from voluntary participation in medical research programs, and from the licensee's disposal of radioactive material into sanitary sewerage in accordance with § 20.2003.

The State of New York Codes, Rules, and Regulations (6 NYCRR), Subpart 380.5, specifies the same requirements and annual dose limits that apply specifically to the SDA.

Thus, operations at the SDA during the next 30 years should be conducted in a manner that ensures that no member of the public receives a total effective dose equivalent of 100 mrem or more in any 1-year period.

The results from this study confirm that NYSERDA will achieve this goal if the SDA continues to be operated with its current physical and administrative controls. Figure 13.1-7 shows that the 90% confidence interval for releases that result in a 1-year dose of 100 mrem, or more, lies well below one release in 30 years. Figure 13.1-8 shows the complete probability distribution for the vertical "slice" through Figure 13.1-7 at the dose of 100 mrem. The full uncertainty distribution shows that there is extremely high confidence that a release with this dose will occur much less often than once in 30 years. There is essentially full confidence that the frequency of releases with this severity is less than approximately one event in 330 years.

Of course, these results should not be interpreted to mean that a release of this magnitude is impossible. They simply indicate that a release with these consequences is extremely unlikely during the next 30 years. If the SDA site could be maintained in its current state in perpetuity (including all geohydrologic and meteorological conditions) we would expect to experience this type of event only once in approximately 1,965 years.

Those familiar with quantitative risk assessments for other types of facilities may note that the uncertainties displayed in Figure 13.1-1 seem rather small. This is primarily due to the fact that the overall risk is the sum of several distinct contributors. Section 13.2 describes those contributors in more detail, including their associated uncertainties. At the "high frequency / low consequence" end of the risk spectrum (i.e., the left edge of Figure 13.1-1), the risk is dominated by natural processes and weather phenomena for which there are relatively small uncertainties in the event occurrence frequencies. This is evidenced by the fact that the uncertainty in the frequency of these events spans much less than one decade on the y-axis.

However, there is relatively large uncertainty in the consequences from these events. This uncertainty is displayed by the fact that the 90% confidence interval for the consequential doses spans almost one decade on the x-axis.

At the "low frequency / high consequence" end of the risk spectrum (i.e., the right edge of Figure 13.1-1), the risk is dominated by extremely severe disruptive events for which there are much larger uncertainties in the event occurrence frequencies. This is evidenced by the fact that the uncertainty in the frequency of these events spans approximately two decades on the y-axis. In fact, there are very large uncertainties in the individual event frequencies. However, the probabilistic sum of these contributors tends to reduce the numerical impacts from the low probability "tails" of their uncertainty distributions, especially within the 90% confidence interval that is shown in Figure 13.1-1. There is less uncertainty in the consequences from these events. This uncertainty is displayed by the fact that the 90% confidence interval for the consequential doses spans much less than one decade on the x-axis.

The SDA QRA results deviate somewhat from the "classic" risk curve format through the transition from the "intermediate frequency / intermediate consequence" range to the "low frequency / high consequence" range of the risk spectrum (i.e., moving from left to right in Figure 13.1-1). The uncertainties in both the frequency of releases (measured on the y-axis) and the doses from those releases (measured on the x-axis) increase visibly over the dose range from approximately 1,000 mrem in one year to approximately 50,000 mrem in one year. As noted above, the results show that there is large uncertainty about the frequency of very large releases. However, at the high end of the dose spectrum, the uncertainty in the doses is reduced, and the curves converge horizontally. This phenomenon is due primarily to the fact that the upper end of dose range is dominated by extremely severe events that cause direct releases from essentially all of the waste trenches (e.g., global landslides in Release Mechanism 4). There is very large uncertainty about the occurrence frequencies of these rare events. However, if such an event were to occur, there is relatively lower uncertainty about its consequences, because they are based on the total inventory of material in the trenches. Thus, the high-dose uncertainties are less than those in the lower dose ranges, which include contributions from a broad variety of release scenarios.

Section 13.3 provides additional information about uncertainties in the risk results and their interpretation.

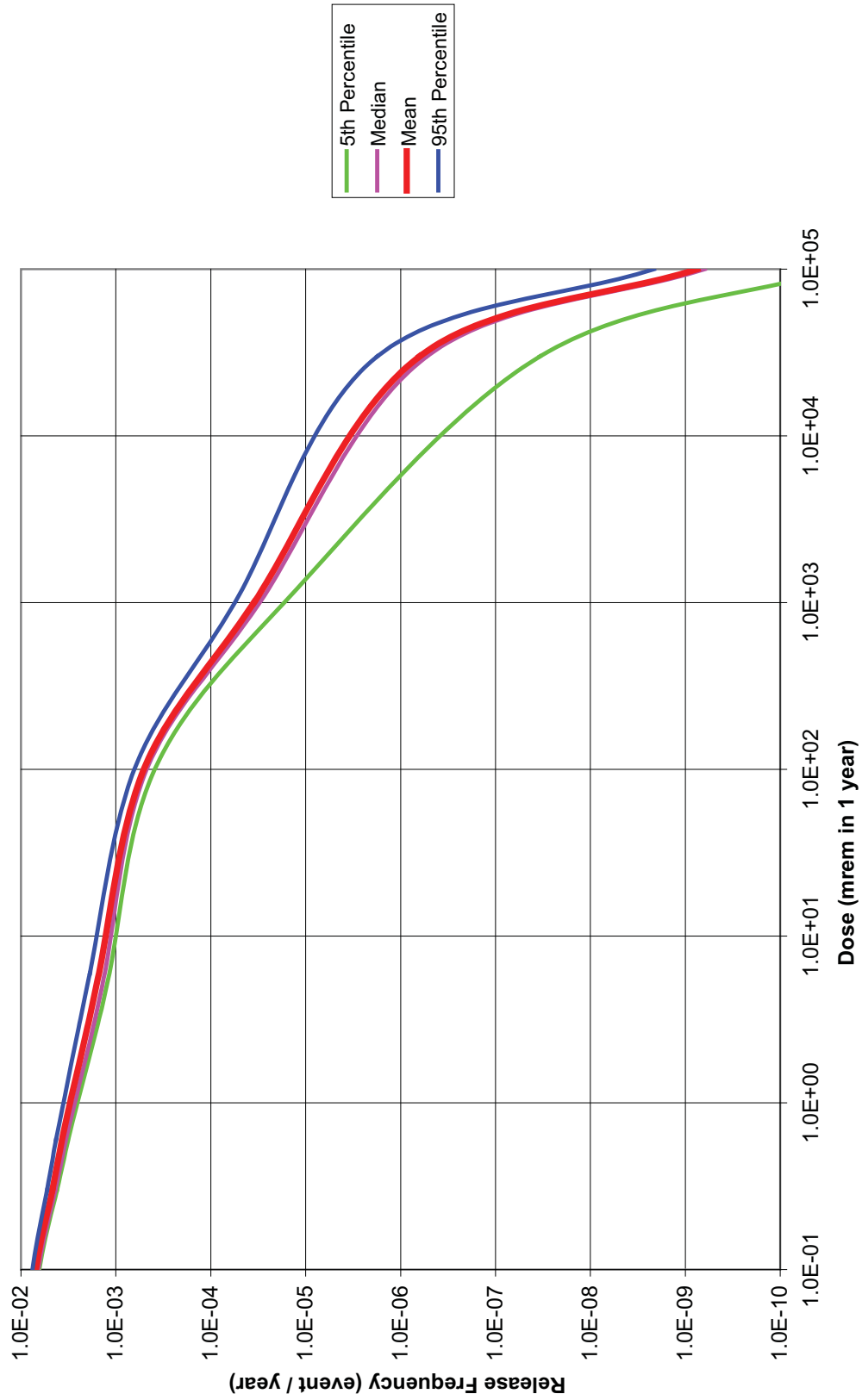

Figure 13.1-1. SDA Risk Curves, Exceedance Frequency Format

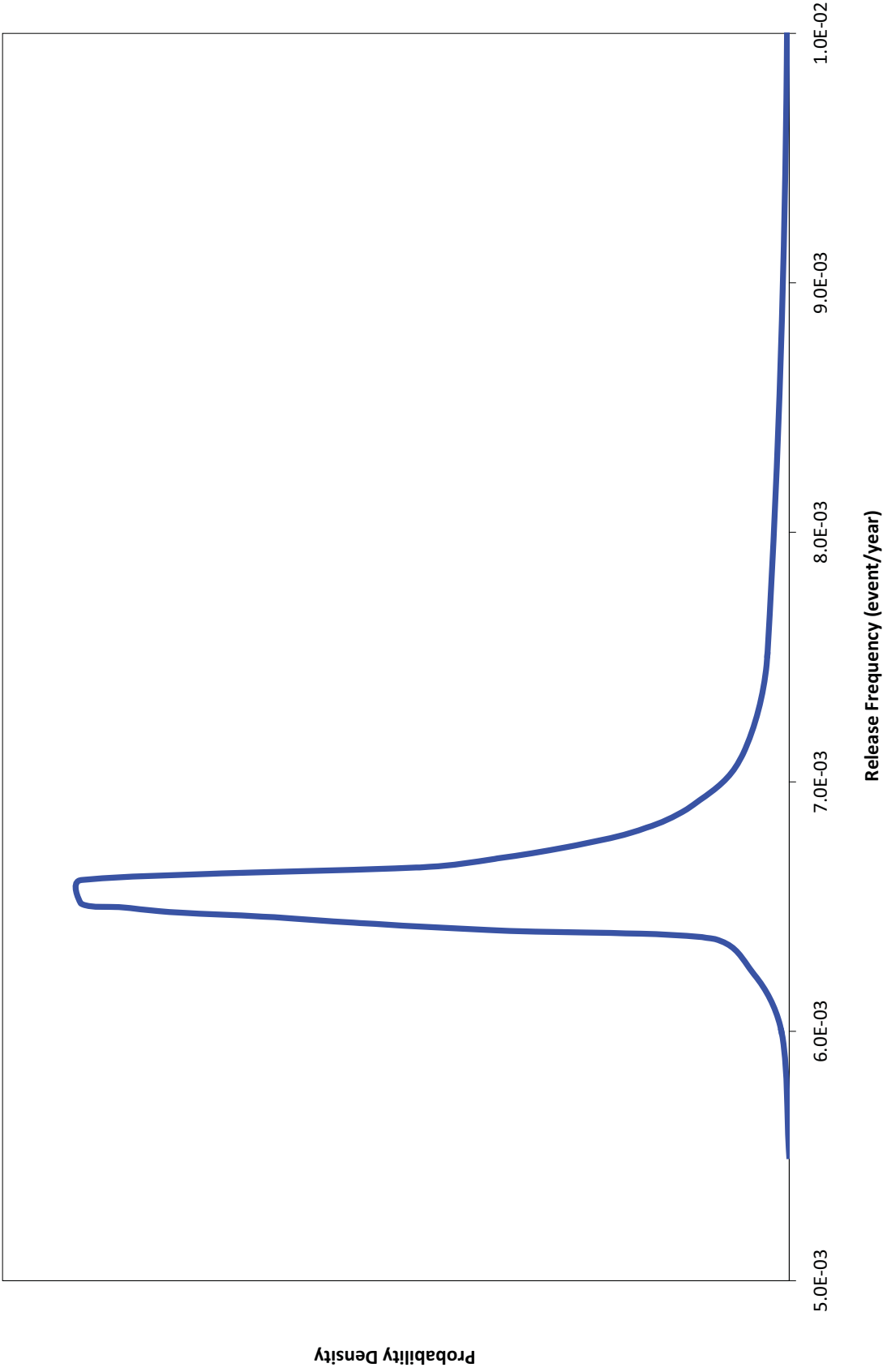

Figure 13.1-2. Release Frequency for Exceeding a Dose of 0.1 mrem in 1 Year, Probability Density Format

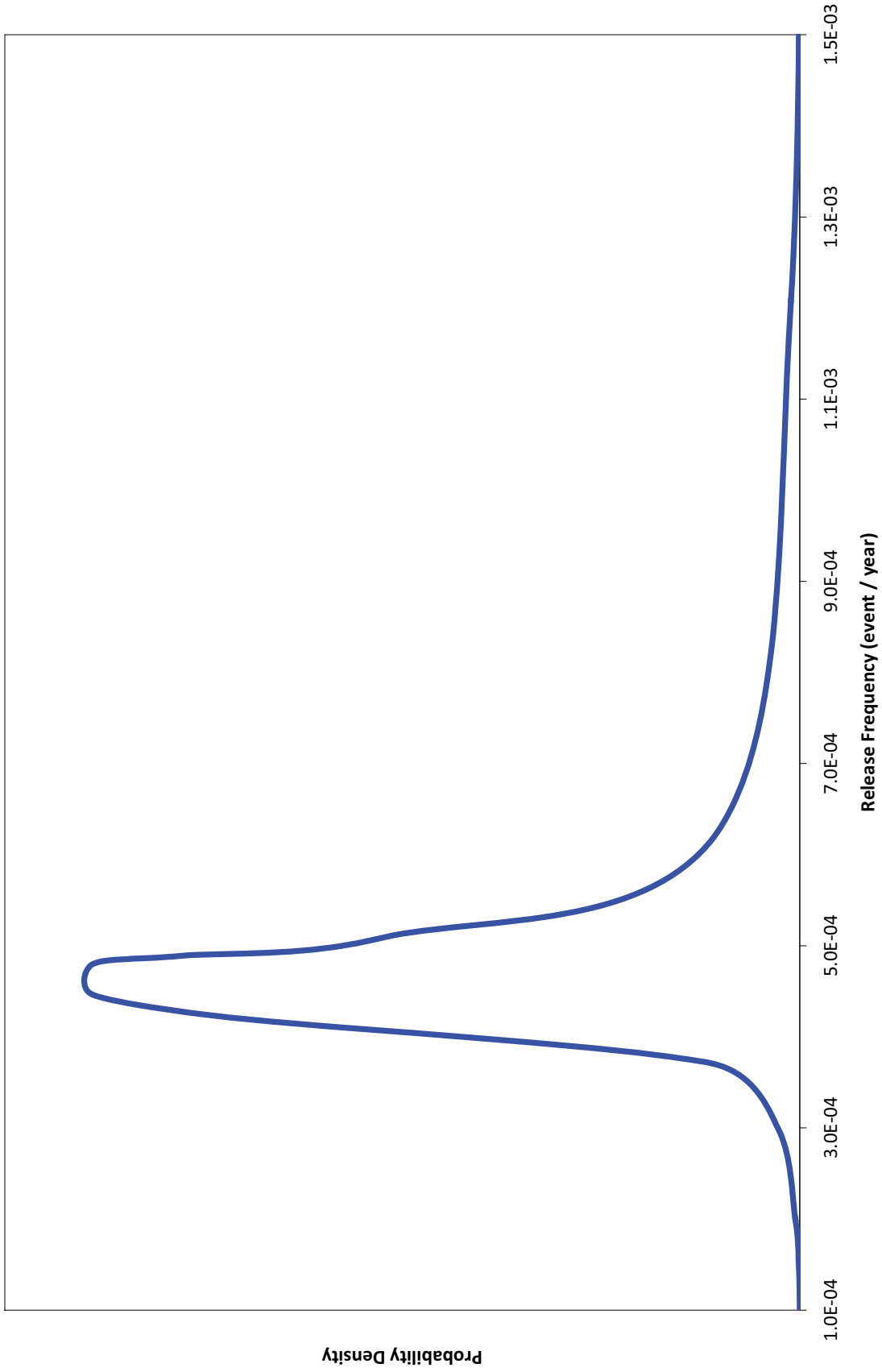

Figure 13.1-3. Release Frequency for Exceeding a Dose of 100 mrem in 1 Year, Probability Density Format

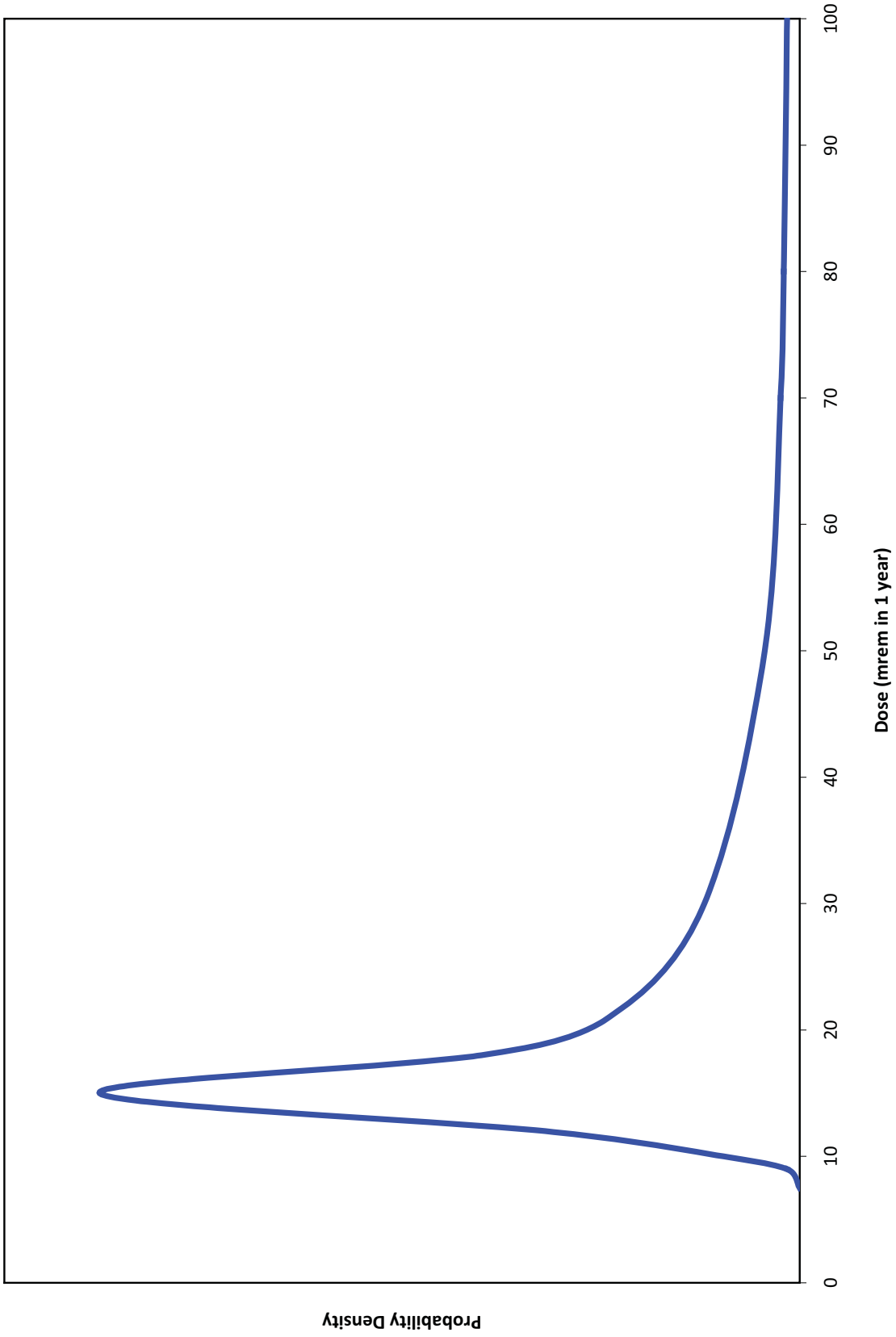

Figure 13.1-4. Uncertainty in Dose for Release Frequency of 1.0E-03 Event per Year, Probability Density Format

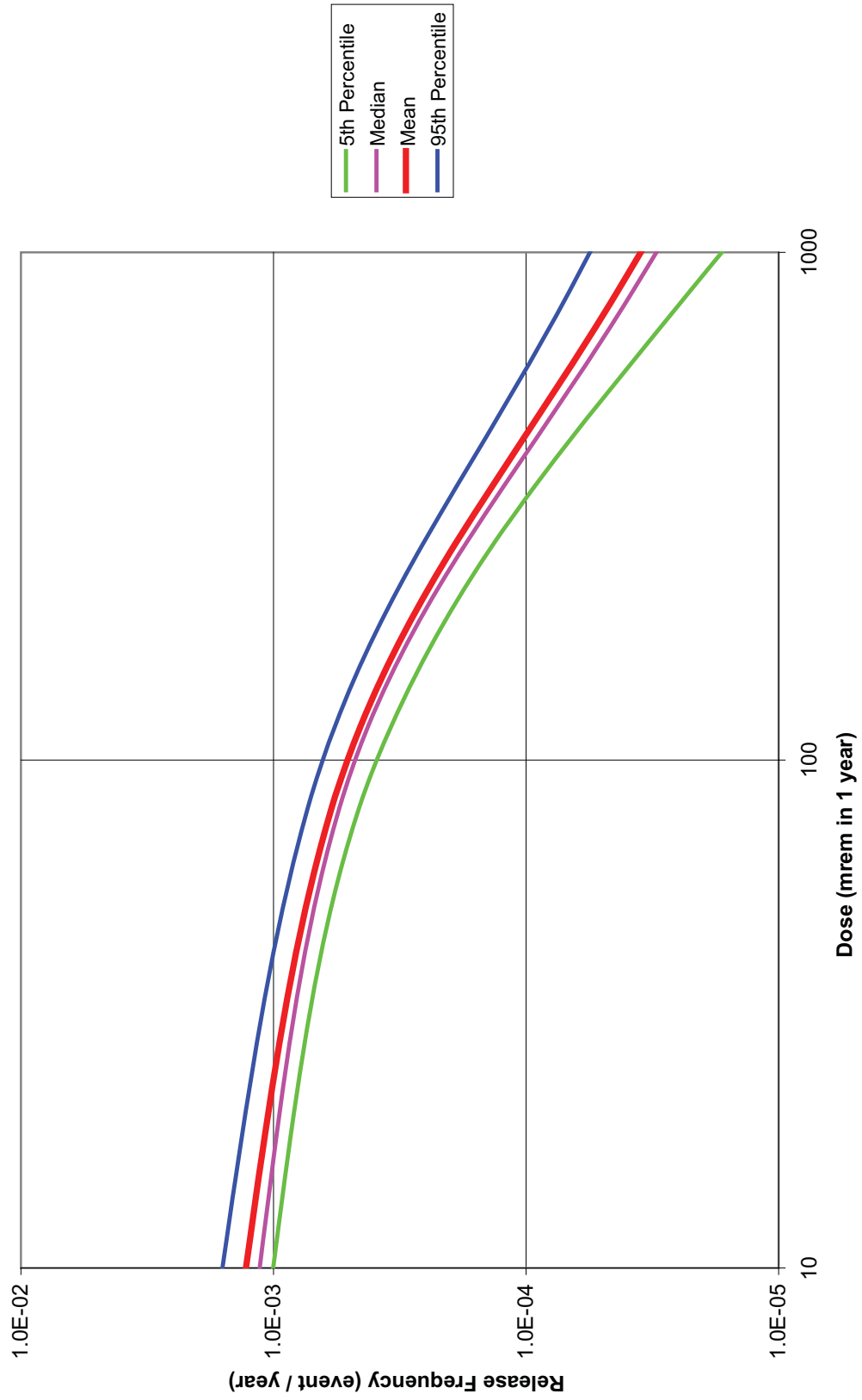

Figure 13.1-5. SDA Risk Curves, Exceedance Frequency Format (Expanded Scale)

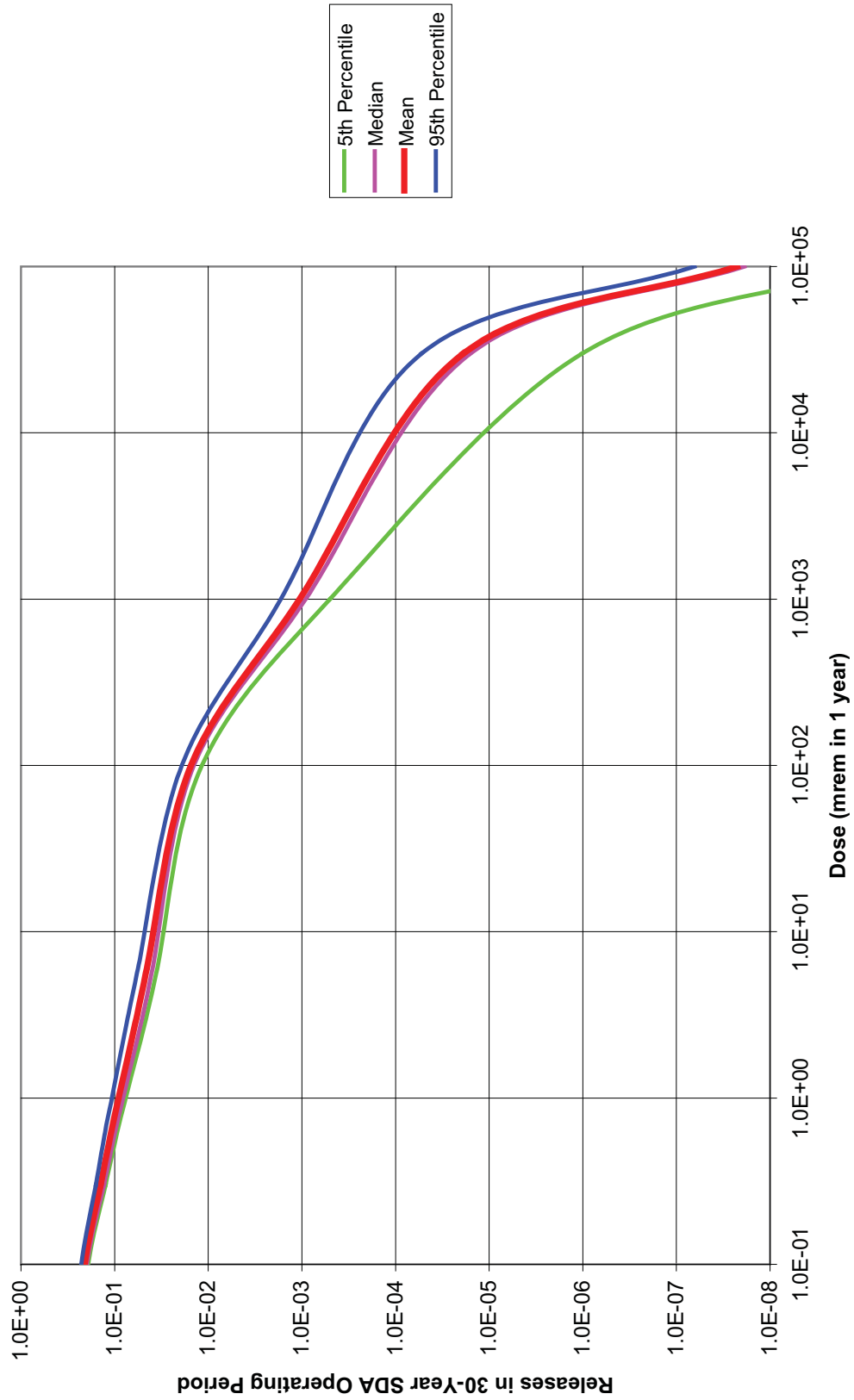

Figure 13.1-6. SDA Risk Curves, 30-Year Operation Period Exceedance Format

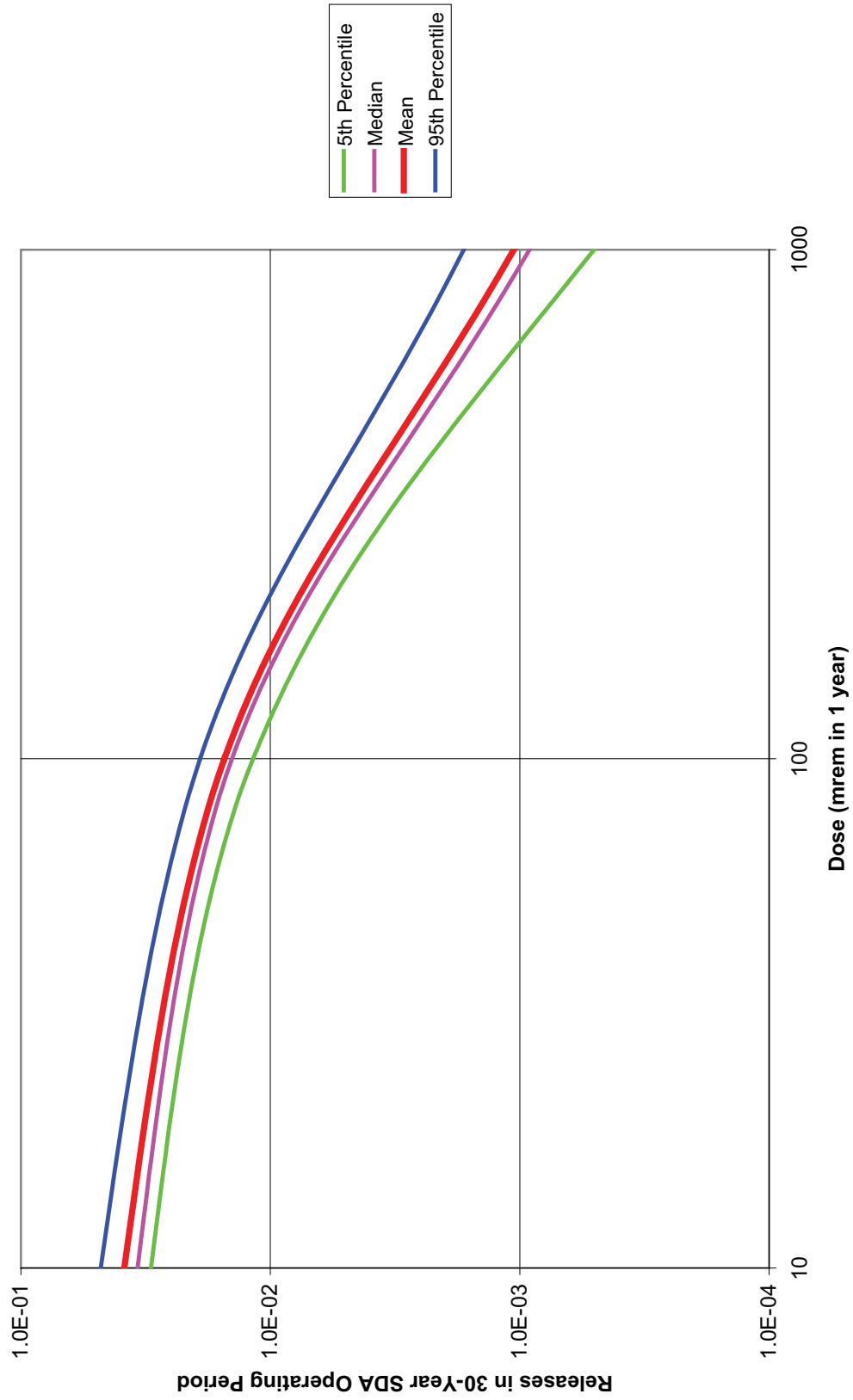

Figure 13.1-7. SDA Risk Curves, 30-Year Operation Period Exceedance Format (Expanded Scale)

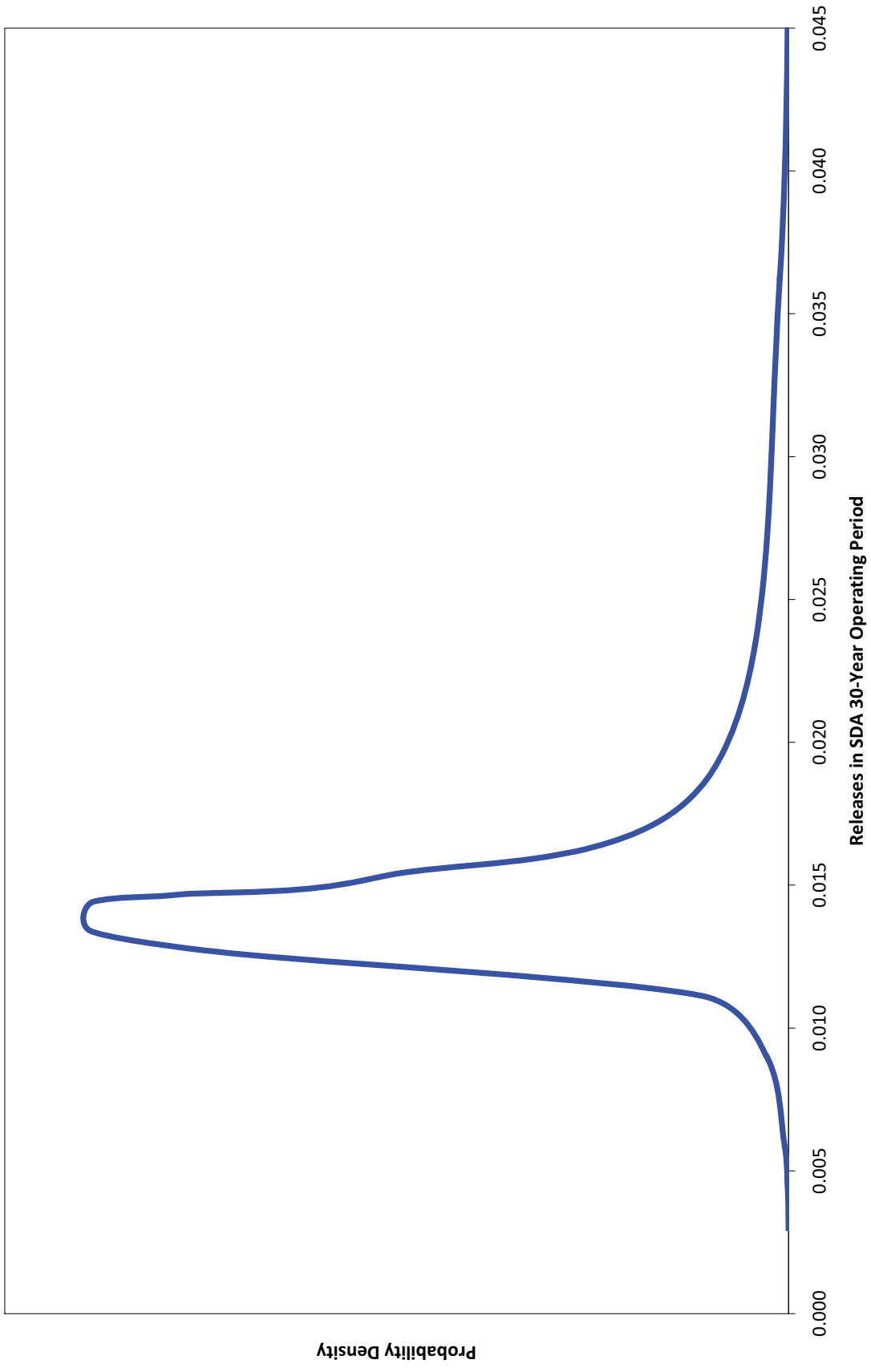

Figure 13.1-8. Releases in SDA 30-Year Operation Period with Doses that Exceed 100 mrem in One Year

13.2 SUMMARY OF RISK CONTRIBUTORS

Section 8 describes the event scenarios that define the logical framework for analysis and quantification of the SDA risk. Section 12 describes the computational format for assembling and quantifying the frequency of each scenario and its consequences. Table 13.2-1 summarizes the results of the scenario quantification process. Three values are listed for each scenario.

- The mean value of the uncertainty distribution for the scenario frequency (i.e., the frequency at which a release of radioactive material occurs from the SDA trenches) (event / year)
- The mean value of the uncertainty distribution for the consequential dose from public exposure to the material that is released during the scenario (mrem in 1 year)
- The mean value of the uncertainty distribution for the product of the scenario frequency and its consequences [(mrem in 1 year) / year]

Each mean value is derived from its underlying uncertainty distribution. The uncertainty distributions are not retroactively approximated by closed-form analytical functions (e.g., normal, lognormal, Weibull, beta, etc.). Therefore, the mean value of the product distribution is not always precisely equal to the product of the mean values of the frequency and dose distributions, due to numerical effects from the Monte Carlo sampling process, and the subsequent accumulation of samples into discrete "bins" for the output distribution.

The relative contribution of each scenario to the overall SDA risk is determined by the product of the scenario frequency and its consequences. This value may be somewhat difficult to understand outside the specific context in which it is used. It accounts for the frequency-normalized dose (measured in units of mrem accumulated in 1 year) from each scenario or, equivalently, the dose per year attributed to that scenario. Comparison of the scenarios on this basis provides a consistent measure of their relative contributions to risk. For example, if Scenario A has frequency X and dose Y , its risk contribution would be the same as Scenario B with frequency $X/2$ and dose $2Y$, and Scenario C with frequency $2X$ and dose $Y/2$.

Only nine scenarios individually account for more than 1% of the total SDA risk, and these nine scenarios collectively account for almost 99% of the total. Each of the remaining 22 scenarios contributes less than 1% of the overall risk, and the 22 scenarios collectively account for just slightly more than 1% of the total. The following sections describe the most important scenarios and the functional conditions that determine their risk contributions. An overview of the remaining 22 scenarios is also provided to describe why they are not important to the overall risk results.

13.2.1 Scenario 1 - 2

Scenario 1 – 2 is the second scenario defined for Release Mechanism 1. It accounts for approximately 29.7% of the total SDA risk. The scenario involves lateral groundwater flows through the Unweathered Lavery Till soil layer. These releases occur when the water levels in the waste trenches are at or near the interface between the ULT and the WLT soil layers, as described in Section 8.2.2.2.

The analyses summarized in Section 6.5 conclude that leachate constituents carried in groundwater will be released into Erdman Brook and Frank's Creek within the 30-year period of this study for most analyzed conditions when the trench levels are at the ULT / WLT interface. The frequency of this scenario in Table 13.2-1 accounts for the 1.37% probability that the ULT / WLT water level condition applies throughout the 30-year SDA operation period. That probability is derived from the analyses that are summarized in Section 6.7. However, if the levels are at this interface, there is relatively small uncertainty that these releases will occur.

The duration of these releases is limited by NYSEDA detection of contamination in the stream water samples, with subsequent efforts to stop the release or divert it from entering the affected stream, as described in Section 8.2.2.3. There is moderate uncertainty about the NYSEDA detection, intervention, and mitigation times, with a 90% confidence interval that varies from approximately 30 days to 77 days.

The radioisotopic mobilization, transport, and dose analyses for this scenario are based on unretarded releases of all radionuclide species in the trench leachate. This assumption conservatively accounts for potential flows through fractures and discontinuities in the shallow segments of the ULT soil layer.

Figure 13.2-1 shows the cumulative probability distribution for the conditional dose from Scenario 1 – 2. The lower bound of the distribution shown in Figure 13.2-1 (i.e., 1.0E-20 mrem in 1 year) is a mathematical surrogate to facilitate plotting of these results. The actual computed value is precisely zero (0). The major parameters of this distribution are summarized below.

Conditional Dose from Scenario 1 – 2 (mrem in 1 year)				
5th Percentile	Median	Mean	95th Percentile	Error Factor
0	0.04	175	251	--

There is extremely large uncertainty in the estimated dose. There is approximately 27% probability that the conditional dose from this scenario is zero (i.e., that there are no measurable consequences). The error factor cannot be computed by traditional methods, because the 5th percentile of this distribution is numerically zero. The mean value of the uncertainty distribution is more than 4000 times higher than the median value, which indicates that the upper end "tail" of Figure 13.2-1 almost completely determines the overall results.

The uncertainty in the conditional dose from Scenario 1 – 2 is determined almost entirely by the uncertainty in the results from the groundwater flow analyses for these hydraulic conditions. Figure 13.2-2 shows the results from those analyses. As above, the lower bound of 1.0E-20 is a plotting surrogate for the actual computed release rate of zero (0). The major parameters of the uncertainty distribution are summarized below.

Concentration-Weighted Groundwater Releases through ULT during Scenario 1 – 2 (cubic feet / second)				
5th Percentile	Median	Mean	95th Percentile	Error Factor
0	1.35E-05	3.84E-03	1.90E-02	--

There is approximately 27% probability that the release rate from this scenario is zero (i.e., that no measurable amounts of leachate are released into the adjacent streams during the 30-year study period). The mean value of the uncertainty distribution is more than 280 times higher than the median value, which indicates that the upper end "tail" of Figure 13.2-2 very strongly influences the overall results.

The uncertainty in the conditional dose from Scenario 1 – 2 is also influenced by the uncertainty in the radionuclide concentrations in the liquid that is released from the trenches. Section 9.2 describes the analyses that account for uncertainties in the concentrations of each radionuclide in the trench solids and uncertainties in the empirical distribution coefficients that are used to derive the liquid concentrations.

The risk contribution from Scenario 1 – 2 accounts for the updated trench water level analyses described in Section 6.7 and the evaluation of NYSERDA stream water sampling and mitigation responses summarized in Section 8.2.2.3. Two potential refinements to the supporting analyses for this scenario may reduce remaining sources of conservatism.

- It may be possible to refine the groundwater flow models, supporting data, and analyses to reduce the uncertainties in the release flow rates for these hydraulic conditions.
- Analyses of leachate samples from each trench or further refinements to the empirical distribution coefficients used in this study may provide improved estimates for the concentrations of specific radionuclides in the trench liquid.

13.2.2 Scenario 4 – 1c

Release Mechanism 4 involves physical breaches of the waste trenches and releases of liquid and solid radioactive materials. Damage condition 1 accounts for localized landslides and seismic events that cause failures of the adjacent slopes, which breach Trenches 1/2 and Trench 8 along the East side of the SDA and approximately 125 feet of the north ends of Trenches 3, 4, and 5. Scenario 4 – 1c evaluates liquid releases from these trenches during conditions when the trench water levels are at their current elevations, or lower. It accounts for approximately 22.7% of the total SDA risk.

The frequency of this scenario in Table 13.2-1 takes into account the 98.51% probability that trench water levels will remain at their current elevations or lower throughout the 30-year SDA operation period. That probability is derived from the analyses that are summarized in Section 6.7. Thus, approximately 98% of all slope failures in damage condition 1 result in liquid releases via Scenario 4 – 1c. Scenarios 4 – 1a and 4 – 1b respectively account for liquid releases during conditions when water levels are near the tops of the trenches or the ULT / WLT interface. Those scenarios are much less likely than Scenario 4 – 1c, due to the small probabilities that those water level conditions apply.

The scenario frequency contains two contributors. Localized landslides that affect the slopes adjacent to the SDA site account for approximately 97% of the initiating threat frequency. These failures are analyzed in Section 8.5.3.2 and Section 6.3. Seismic events that destabilize the slopes account for approximately 3% of the threat frequency. Those failures are analyzed in Section 8.5.3.1. The major parameters of each uncertainty distribution are summarized below.

Localized Landslide (LOCALS) and Seismic-Induced Slope Failure (SSL0D1) Contributors to Frequency of Scenario 4 – 1 (event / year)					
Failure Event	5th Percentile	Median	Mean	95th Percentile	Error Factor
LOCALS	1.21E-07	4.77E-05	5.77E-05	1.71E-04	37.7
SSL0D1	1.76E-07	1.02E-06	1.74E-06	5.49E-06	5.6

Figure 13.2-3 shows the cumulative probability distributions for the landslide and seismic event damage frequencies. The uncertainty distribution for the landslide damage is somewhat oddly shaped because it is derived from a convolution of the discrete probability distributions that are described in Section 6.3.3.1. The long "tail" that extends to low frequencies accounts for the conclusion that a relatively large percentage of the slope failures will not breach the trenches when water levels are at their current elevations, or lower. The error factor that is listed above is also somewhat misleading because it accounts for the full 90% confidence interval between the 95th probability percentile and the very skewed 5th probability percentile. By comparison, the 45% probability range between the median value and the 95th percentile spans only a factor of approximately 3.6 in the damage frequency. The mean frequency is essentially determined by this relatively narrow range. The primary factors which govern this portion of the distribution are the upper range for the estimated likelihood that a slope failure will occur, given low soil strength and current water level conditions, combined with the upper range of the probability distribution for the conditional likelihood of trench intersection, given a slope failure.

Figure 13.2-4 shows the cumulative probability distribution for the conditional dose from Scenario 4 – 1c. The major parameters of this distribution are summarized below.

Conditional Dose from Scenario 4 – 1c (mrem in 1 year)				
5th Percentile	Median	Mean	95th Percentile	Error Factor
3.75	106	1096	3027	28.4

The uncertainty in the conditional dose from Scenario 4 – 1c is determined almost entirely by the uncertainty in the radionuclide concentrations in the liquid that is released from the trenches. Section 9.2 describes the analyses that account for uncertainties in the concentrations of each radionuclide in the trench solids and uncertainties in the empirical distribution coefficients that are used to derive the liquid concentrations.

Three potential refinements to the supporting analyses for this scenario may reduce remaining sources of conservatism.

- It may be possible to refine the SDA slope stability evaluations and reduce the uncertainties in the assessed likelihood of a non-seismic slope failure during the 30-year study period.
- The SDA damage analyses could be refined to account for different trench intersection probabilities for slope failures that occur along the northern portion of the East slope, the southern portion of the East slope, and at the North end of the site.
- Analyses of leachate samples from each trench or further refinements to the empirical distribution coefficients used in this study may provide improved estimates for the concentrations of specific radionuclides in the trench liquid.

13.2.3 Scenario 4 – 1

Scenario 4 – 1 is very similar to Scenario 4 – 1c. It accounts for the doses from released solid materials, rather than trench liquids. The scenario involves localized landslides and seismic events that cause failures of the adjacent slopes, which breach Trenches 1/2 and Trench 8 along the East side of the SDA and approximately 125 feet of the north ends of Trenches 3, 4, and 5. It accounts for approximately 11.8% of the total SDA risk.

The scenario frequency is determined by the same contributors that are described for Scenario 4 – 1c (i.e., localized landslides and seismic events). These contributors are evaluated in Sections 8.5.3.1 and 8.5.3.2. The frequency of Scenario 4 – 1 in Table 13.2-1 is slightly higher than the frequency of Scenario 4 – 1c, because Scenario 4 – 1c also accounts for the probability that trench water levels are at their current elevations, or lower, when the slope failure occurs. The solid waste material releases that contribute to Scenario 4 – 1 are not influenced by the trench water levels.

Figure 13.2-5 shows the cumulative probability distribution for the conditional dose from Scenario 4 – 1. The major parameters of this distribution are summarized below.

Conditional Dose from Scenario 4 – 1 (mrem in 1 year)				
5th Percentile	Median	Mean	95th Percentile	Error Factor
114	405	540	1391	3.5

The uncertainty in the conditional dose from Scenario 4 – 1 is much smaller than that for Scenario 4 – 1c. It is determined almost entirely by the uncertainty in the radionuclide concentrations in the trench solids, and it is not influenced by the additional uncertainties in the trench liquid concentrations.

The first two potential analysis refinements summarized for Scenario 4 – 1c may also reduce remaining sources of conservatism in this scenario.

13.2.4 Scenario 2 - 1

Scenario 2 – 1 is the only scenario for Release Mechanism 2. It accounts for approximately 10.2% of the total SDA risk. The scenario involves lateral groundwater flows through the Weathered Lavery Till soil layer near the surface of the SDA site. These releases can occur only when the water levels in the waste trenches are higher than the ULT / WLT interface, as described in Section 8.3.2.2.

The groundwater flow analyses summarized in Section 6.5 conclude that leachate will be released into Erdman Brook and Frank's Creek within a relatively short period of time if the trench levels are high. The frequency of this scenario in Table 13.2-1 takes into account the 0.12% probability that the high water level condition applies throughout the 30-year SDA operation period. That probability is derived from the analyses that are summarized in Section 6.7. However, if the levels are high, there is little uncertainty that these releases will occur.

The duration of these releases is limited by NYSERDA detection of contamination in the stream water samples, with subsequent efforts to stop the release or divert it from entering the affected stream, as described in Section 8.3.2.3. There is moderate uncertainty about the NYSERDA detection, intervention, and mitigation times, with a 90% confidence interval that varies from approximately 30 days to 77 days.

The radioisotopic mobilization, transport, and dose analyses for this scenario are based on unretarded releases of all radionuclide species in the trench leachate. This assumption conservatively accounts for potential flows through fractures and discontinuities in the WLT soil layer.

Figure 13.2-6 shows the cumulative probability distribution for the conditional dose from Scenario 2 – 1. The major parameters of this distribution are summarized below.

Conditional Dose from Scenario 2 – 1 (mrem in 1 year)				
5th Percentile	Median	Mean	95th Percentile	Error Factor
0.095	15.9	683	1135	109

There is very large uncertainty in the estimated dose. The mean value of the uncertainty distribution is more than 40 times higher than the median value, which indicates that the upper end "tail" of Figure 13.2-6 has a very significant impact on the overall results.

The uncertainty in the conditional dose from Scenario 2 – 1 is influenced very strongly by the uncertainty in the results from the groundwater flow analyses for these hydraulic conditions. Figure 13.2-7 shows the results from those analyses. The major parameters of the uncertainty distribution are summarized below.

Concentration-Weighted Groundwater Releases through WLT during Scenario 2 – 1 (cubic feet / second)				
5th Percentile	Median	Mean	95th Percentile	Error Factor
9.57E-05	3.26E-03	9.83E-03	4.27E-02	21.1

The uncertainty in the conditional dose from Scenario 2 – 1 is also influenced by the uncertainty in the radionuclide concentrations in the liquid that is released from the trenches. Section 9.2 describes the analyses that account for uncertainties in the concentrations of each radionuclide in the trench solids and uncertainties in the empirical distribution coefficients that are used to derive the liquid concentrations.

The risk contribution from Scenario 2 – 1 accounts for the updated trench water level analyses described in Section 6.7 and the evaluation of NYSERDA stream water sampling and mitigation responses summarized in Section 8.3.2.3. Two potential refinements to the supporting analyses for this scenario may reduce remaining sources of conservatism.

- It may be possible to refine the groundwater flow models, supporting data, and analyses to reduce the uncertainties in the release flow rates for these hydraulic conditions.
- Analyses of leachate samples from each trench or further refinements to the empirical distribution coefficients used in this study may provide improved estimates for the concentrations of specific radionuclides in the trench liquid.

13.2.5 Scenario 1 - 3

Scenario 1 – 3 is the third scenario defined for Release Mechanism 1. It accounts for approximately 6.9% of the total SDA risk. The scenario involves lateral groundwater flows through the ULT soil layer. These releases occur when the water levels in the waste trenches are at their current elevations, as described in Section 8.2.2.2.

The supporting analyses and contributing factors for Scenario 1 – 3 are very similar to those described for Scenario 1 – 2. The primary differences are:

- The frequency of Scenario 1 – 3 takes into account the 93.51% probability that the current water level condition applies throughout the 30-year SDA operation period. That probability is derived from the analyses that are summarized in Section 6.7.
- The lower water level affects the hydraulic head for flows through the ULT soil layer.

The analyses of Scenario 1 – 3 account for the same NYSERDA detection and mitigation efforts to limit the duration of these releases. The radioisotopic mobilization, transport, and dose analyses for this scenario also account for unretarded releases of all radionuclide species in the trench leachate.

Figure 13.2-8 shows the cumulative probability distribution for the conditional dose from Scenario 1 – 3. The major parameters of this distribution are summarized below.

Conditional Dose from Scenario 1 – 3 (mrem in 1 year)				
5th Percentile	Median	Mean	95th Percentile	Error Factor
0	9.5E-10	0.59	0.67	--

There is approximately 39% probability that the conditional dose from this scenario is zero (i.e., that there are no measurable consequences). The mean value of the uncertainty distribution is more than eight orders of magnitude higher than the median value. The mean value is also just slightly smaller than the 95th probability percentile, which indicates that the upper end "tail" of Figure 13.2-8 completely determines the overall results.

The uncertainty in the conditional dose from Scenario 1 – 3 is determined almost entirely by the uncertainty in the results from the groundwater flow analyses for these hydraulic conditions. Figure 13.2-9 shows the results from those analyses. The major parameters of the uncertainty distribution are summarized below.

Concentration-Weighted Groundwater Releases through ULT during Scenario 1 – 3 (cubic feet / second)				
5th Percentile	Median	Mean	95th Percentile	Error Factor
0	2.7E-12	1.9E-04	1.0E-03	--

There is approximately 40% probability that the release rate from this scenario is zero (i.e., that no measurable amounts of leachate are released into the adjacent streams during the 30-year study period). The mean value of the uncertainty distribution is almost eight orders of magnitude higher than the median value. The mean value is also approximately a factor of 5 lower than the 95th probability percentile, which indicates that the upper end "tail" of Figure 13.2-9 very strongly influences the overall results.

The uncertainty in the conditional dose from Scenario 1 – 3 is also influenced by the uncertainty in the radionuclide concentrations in the liquid that is released from the trenches. Section 9.2 describes the analyses that account for uncertainties in the concentrations of each radionuclide in the trench solids and uncertainties in the empirical distribution coefficients that are used to derive the liquid concentrations.

The same potential analysis refinements summarized for Scenario 1 – 2 may also reduce remaining sources of conservatism in this scenario.

13.2.6 Scenario 3 - 4

Scenario 3 – 4 is the fourth scenario defined for Release Mechanism 3. It accounts for approximately 6.4% of the total SDA risk. The scenario involves initial site conditions when the geomembranes are not intact, and the trench compacted clay caps are in their normal state. Water levels in the waste trenches are at or near the interface between the ULT and the WLT soil layers, as described in Section 8.4.2.1. Total precipitation during a 14-day exposure period exceeds 9 inches, including at least one storm with rainfall intensity that is severe enough to

erode the trench caps and allow water intrusion to fill the trenches. The risk from Scenario 3 – 4 is the product of four contributors.

Trench Water Levels

Scenario 3 – 4 occurs when trench water levels are at or near the interface between the ULT and WLT soil layers. The frequency of this scenario in Table 13.2-1 takes into account the 1.37% probability that the ULT / WLT water level condition applies throughout the 30-year SDA operation period. That probability is derived from the analyses that are summarized in Section 6.7. The analyses in Section 6.6 conclude that approximately 8.7 inches of precipitation is required to fill the trenches from this level, if the clay caps do not effectively prevent water intrusion.

Geomembrane Unavailability

The analyses in Section 7.2 evaluate several causes for geomembrane unavailability. Table 13.2-2 lists the specific conditions that contribute to geomembrane unavailability prior to the initiating event for this scenario. The following items summarize the most important contributing conditions.

- Damage to the geomembranes from severe erosion and headward migration of gullies in the slopes along the north end of the SDA adjoining Erdman Brook or along the east side of the SDA adjoining Frank's Creek accounts for approximately 60% of the unavailability. The frequency of this erosion damage is quantified in Section 6.4.4.2, and the geomembrane replacement time is quantified in Section 7.2.4.1. The mean frequency of damaging erosion events is $1.64\text{E-}02$ event per year (one event in approximately 61 years), and the mean geomembrane replacement time is 257 days (approximately 0.70 year).
- Planned replacement of the geomembranes collectively accounts for approximately 20% of the unavailability. These contributions are evaluated in Section 7.2.4.2. They are based on current NYSERDA estimates of a 25% probability that the old cover will be substantially removed before each new membrane is installed. The mean replacement time for the VLDPE cover is 57 days (approximately 0.16 year), and the mean replacement time for the XR-5 cover is 114 days (approximately 0.31 year).
- Damage from wildfires in the vicinity of the SDA site accounts for approximately 16.5% of the geomembrane unavailability. The mean frequency of these fires is quantified in Section 5.8.1, and is $4.66\text{E-}03$ event per year (one event in approximately 215 years). The 257-day geomembrane mean replacement time after fire damage is the same as after erosion damage.

Table 13.2-2 shows that moderate to relatively large uncertainties apply to the contributions from erosion and wildfire damage. If the old covers are removed during the planned replacement projects, the uncertainty about those unavailability contributions is quite small.

Precipitation Events

The potential releases during Scenario 3 – 4 depend on both the storm severity (rate of precipitation) and the duration of the storm period (cumulative precipitation). A 14-day interval is used as the maximum threat exposure period in these analyses. This period accounts for

NYSERDA detection of erosive damage to the trench caps and implementation of mitigation measures to reduce the rate of water intrusion, to actively pump water out of the trenches, or to divert runoff away from the adjacent streams, as described in Section 8.4.2.2.

The initiating threat for Scenario 3 – 4 is precipitation that exceeds 9 inches during the 14-day exposure period before NYSERDA intervention. Figure 5.2-15 shows the 14-day precipitation exceedance curves that were derived from the regional weather data. Figure 13.2-10 shows the cumulative probability distribution for the vertical "slice" through Figure 5.2-15 at the 14-day precipitation amount of 9 inches. The major parameters of the uncertainty distribution are summarized below.

Exceedance Frequency for 9 Inches of Precipitation in 14 Days (event / year)				
5th Percentile	Median	Mean	95th Percentile	Error Factor
0.043	0.39	0.98	3.4	8.8

More detailed examination of the supporting data provides the following contributors to these precipitation events.

Precipitation Total (inches in 14 days)	Mean Frequency	Fraction of IPRE9
9 – 13	9.21E-01	9.43E-01
13 – 15	4.02E-02	4.12E-02
15 – 16	4.34E-03	4.44E-03
16 – 18	7.24E-03	7.41E-03
18 – 19	1.20E-03	1.23E-03
19 – 21	1.57E-03	1.61E-03
21 – 22	4.04E-04	4.14E-04
22 – 24	3.86E-04	3.95E-04
24 – 25	1.33E-04	1.36E-04
> 25	2.73E-04	2.79E-04
Total	9.77E-01	1.00

Thus, approximately 94% of the initiating threats for Scenario 3 – 4 involve 14-day precipitation totals in the range of 9 to 13 inches, including at least one severe storm.

Trench Liquid Release and Dose Analyses

Section 8.4.3.2 describes the analyses that were performed to correlate the trench liquid overflow volumes, the corresponding leachate release rates, and the streamwater dilution flows for each range of incident precipitation that exceeds 8.7 inches.

Figure 13.2-11 shows the cumulative probability distribution for the conditional dose from Scenario 3 – 4. The major parameters of this distribution are summarized below.

Conditional Dose from Scenario 3 – 4 (mrem in 1 year)				
5th Percentile	Median	Mean	95th Percentile	Error Factor
0.24	6.8	69.7	196	28.6

There is large uncertainty in the estimated dose from this scenario. The mean value of the uncertainty distribution is slightly more than 10 times higher than the median value, which indicates that the upper end "tail" of Figure 13.2-11 has a significant impact on the overall results.

The uncertainty in the conditional dose from Scenario 3 – 4 is also influenced by the uncertainty in the radionuclide concentrations in the liquid that is released from the trenches. Section 9.2 describes the analyses that account for uncertainties in the concentrations of each radionuclide in the trench solids and uncertainties in the empirical distribution coefficients that are used to derive the liquid concentrations.

Potential Risk Improvements

The risk contribution from Scenario 3 – 4 accounts for the updated trench water level analyses described in Section 6.7 and the correlation between trench release rates and stream flows summarized in Section 8.4.3.2. Two potential improvements may reduce remaining sources of conservatism.

- The risk contribution from this scenario will be greatly reduced if NYSERDA actively minimizes the amount of time that the geomembrane covers are not intact, and the surface of the trench caps is exposed. This includes expedited repairs or replacement of damaged geomembrane sections, and minimizing the time and extent of surface uncovering during planned geomembrane replacements.
- Analyses of leachate samples from each trench or further refinements to the empirical distribution coefficients used in this study may provide improved estimates for the concentrations of specific radionuclides in the trench liquid.

13.2.7 Scenario 1 - 4

Scenario 1 – 4 is the fourth scenario defined for Release Mechanism 1. It accounts for approximately 4.4% of the total SDA risk. The scenario involves vertical flow through the Unweathered Lavery Till soil layer and subsequent lateral flow through the Kent Recessional Sequence soils, with discharges to Buttermilk Creek. The groundwater flow analyses for this

release pathway are performed under conditions that are not sensitive to the initial water level in the trenches. Therefore, the results from those analyses apply for all trench water levels.

The analyses summarized in Section 6.5 conclude that leachate constituents carried in groundwater will be released into Buttermilk Creek within the 30-year period of this study for more than half of the analyzed hydraulic conditions. The frequency of this scenario in Table 13.2-1 accounts for the fact that these releases do not depend strongly on the initial trench water level. If a release occurs, there is relatively small uncertainty that it will occur during the 30-year SDA operation period.

The duration of these releases is limited by NYSERDA detection of contamination in Buttermilk Creek water samples, with subsequent efforts by NYSERDA or other local authorities to limit further exposure of all potential receptors in the affected area, as described in Section 8.2.2.4. There is moderate uncertainty about the NYSERDA detection, intervention, and mitigation times, with a 90% confidence interval that varies from approximately 30 days to 77 days.

The radioisotopic mobilization, transport, and dose analyses for this scenario are based on releases of only unretarded radionuclide species in the trench leachate (e.g., H-3, C-14, I-129, and Tc-99). This assumption accounts for relative homogeneity and compaction of the deep ULT soil layer.

Figure 13.2-12 shows the cumulative probability distribution for the conditional dose from Scenario 1 – 4. The lower bound of the distribution shown in the Figure 13.2-12 (i.e., 1.0E-20 mrem in 1 year) is a mathematical surrogate to facilitate plotting of these results. The actual computed value is precisely zero (0). The major parameters of this distribution are summarized below.

Conditional Dose from Scenario 1 – 4 (mrem in 1 year)				
5th Percentile	Median	Mean	95th Percentile	Error Factor
0	3.2E-15	0.35	0.15	--

There is extremely large uncertainty in the estimated dose. There is approximately 45% probability that the conditional dose from this scenario is zero (i.e., that there are no measurable consequences). The error factor cannot be computed by traditional methods, because the 5th percentile of this distribution is numerically zero. The mean value of the uncertainty distribution is many times higher than the median value, and it is higher than the 95th percentile value. These conditions indicate that the upper end "tail" of Figure 13.2-12 completely determines the overall results.

The uncertainty in the conditional dose from Scenario 1 – 4 is determined almost entirely by the uncertainty in the results from the groundwater flow analyses for these hydraulic conditions. Figure 13.2-13 shows the results from those analyses. As above, the lower bound of 1.0E-20 is a plotting surrogate for the actual computed release rate of zero (0). The major parameters of the uncertainty distribution are summarized below.

Concentration-Weighted Groundwater Releases through ULT and KRS during Scenario 1 – 4 (cubic feet / second)				
5th Percentile	Median	Mean	95th Percentile	Error Factor
0	5.16E-18	1.22E-04	4.45E-04	--

There is approximately 45% probability that the release rate from this scenario is zero (i.e., that no measurable amounts of leachate are released into the adjacent streams during the 30-year study period). The mean value of the uncertainty distribution is many times higher than the median value, although it is lower than the 95th percentile value. The upper end "tail" of Figure 13.2-13 very strongly influences the overall results.

The uncertainty in the conditional dose from Scenario 1 – 4 is also influenced by the uncertainty in the radionuclide concentrations in the liquid that is released from the trenches. Section 9.2 describes the analyses that account for uncertainties in the concentrations of each radionuclide in the trench solids and uncertainties in the empirical distribution coefficients that are used to derive the liquid concentrations.

The same potential analysis refinements summarized for Scenario 1 – 2 may also reduce remaining sources of conservatism in this scenario.

13.2.8 Scenario 1 - 1

Scenario 1 – 1 is the first scenario defined for Release Mechanism 1. It accounts for approximately 4.3% of the total SDA risk. The scenario involves lateral groundwater flows through the ULT soil layer. These releases occur when the water levels in the waste trenches are above the ULT / WLT interface, as described in Section 8.2.2.2.

The supporting analyses and contributing factors for Scenario 1 – 1 are very similar to those described for Scenario 1 – 2. The primary differences are:

- The frequency of Scenario 1 – 1 takes into account the 0.12% probability that the high water level condition applies throughout the 30-year SDA operation period. That probability is derived from the analyses that are summarized in Section 6.7.
- The high water level affects the hydraulic head for flows through the ULT soil layer.

The analyses of Scenario 1 – 1 account for the same NYSERDA detection and mitigation efforts to limit the duration of these releases. The radioisotopic mobilization, transport, and dose analyses for this scenario also account for unretarded releases of all radionuclide species in the trench leachate.

Figure 13.2-14 shows the cumulative probability distribution for the conditional dose from Scenario 1 – 1. The major parameters of this distribution are summarized below.

Conditional Dose from Scenario 1 – 1 (mrem in 1 year)				
5th Percentile	Median	Mean	95th Percentile	Error Factor
0	0.11	291	316	--

There is approximately 24% probability that the conditional dose from this scenario is zero (i.e., that there are no measurable consequences). The mean value of the uncertainty distribution is more than 2600 times higher than the median value, which indicates that the upper end "tail" of Figure 13.2-14 almost completely determines the overall results.

The uncertainty in the conditional dose from Scenario 1 – 1 is determined almost entirely by the uncertainty in the results from the groundwater flow analyses for these hydraulic conditions. Figure 13.2-15 shows the results from those analyses. The major parameters of the uncertainty distribution are summarized below.

Concentration-Weighted Groundwater Releases through ULT during Scenario 1 – 1 (cubic feet / second)				
5th Percentile	Median	Mean	95th Percentile	Error Factor
0	3.76E-05	4.99E-03	2.47E-02	--

There is approximately 25% probability that the release rate from this scenario is zero (i.e., that no measurable amounts of leachate are released into the adjacent streams during the 30-year study period). The mean value of the uncertainty distribution is approximately 133 times higher than the median value, which indicates that the upper end "tail" of Figure 13.2-15 very strongly influences the overall results.

The uncertainty in the conditional dose from Scenario 1 – 1 is also influenced by the uncertainty in the radionuclide concentrations in the liquid that is released from the trenches. Section 9.2 describes the analyses that account for uncertainties in the concentrations of each radionuclide in the trench solids and uncertainties in the empirical distribution coefficients that are used to derive the liquid concentrations.

The same potential analysis refinements summarized for Scenario 1 – 2 may also reduce remaining sources of conservatism in this scenario.

13.2.9 Scenario 3 - 3

Scenario 3 – 3 is the third scenario defined for Release Mechanism 3. It accounts for approximately 2.0% of the total SDA risk. The scenario involves initial site conditions when the geomembranes are not intact, and the trench compacted clay caps are physically disrupted. Water levels in the waste trenches are at or near the trench tops, as described in Section 8.4.2.1. Total precipitation during a 14-day exposure period exceeds 1 inch, which causes the trenches to overflow. The risk from Scenario 3 – 3 is the product of four contributors.

Trench Water Levels

Scenario 3 – 3 occurs when trench water levels are at or near the trench tops. The frequency of this scenario in Table 13.2-1 takes into account the 0.12% probability that the high water level condition applies throughout the 30-year SDA operation period. That probability is derived from the analyses that are summarized in Section 6.7. Since the clay caps are not available as a barrier against water intrusion, the trenches will overflow if at least 1 inch of precipitation occurs during the 14-day exposure period.

Geomembrane Unavailability

The analyses in Section 7.2 evaluate several causes for geomembrane unavailability. Table 13.2-3 lists the specific conditions that contribute to geomembrane unavailability with correlated damage to the trench clay caps prior to the initiating event for this scenario. Impacts by meteorites, commercial aircraft, and military aircraft are likely to cause substantial physical disruption of the SDA site. The analyses assume that the clay caps will be disrupted by seismic events with peak ground accelerations that exceed the site design basis, to account for possible fracturing of the SDA surface. It is also conservatively assumed that impacts by general aviation aircraft will disrupt the clay caps, to account for the largest aircraft that are included in this broad category. Table 13.2-3 shows that moderate to relatively large uncertainties apply to these contributors.

Precipitation Events

Scenario 3 – 3 accounts for conditions when the trench clay caps are not available as a barrier against water intrusion. Therefore, potential releases during this scenario depend only on cumulative precipitation. A 14-day interval is used as the maximum threat exposure period in these analyses. This period accounts for NYSERDA detection of initial water releases from the trenches and implementation of mitigation measures to reduce the rate of water intrusion, to actively pump water out of the trenches, or to divert runoff away from the adjacent streams, as described in Section 8.4.2.2.

The initiating threat for Scenario 3 – 3 is precipitation that exceeds 1 inch during the 14-day exposure period before NYSERDA intervention. Figure 5.2-15 shows the 14-day precipitation exceedance curves that were derived from the regional weather data. Figure 13.2-16 shows the cumulative probability distribution for the vertical "slice" through Figure 5.2-15 at the 14-day precipitation amount of 1 inch. The major parameters of the uncertainty distribution are summarized below.

Exceedance Frequency for 1 Inch of Precipitation in 14 Days (event / year)				
5th Percentile	Median	Mean	95th Percentile	Error Factor
176	220	223	275	1.3

This distribution evaluates the number of randomly-selected 14-consecutive-day periods during a year when the cumulative precipitation exceeds 1 inch. There is relatively small uncertainty in this data, due to the small amount of required precipitation and the extensive historical meteorological records from the regional weather stations.

More detailed examination of the supporting data provides the following contributors to these precipitation events.

Precipitation Total (inches in 14 days)	Mean Frequency	Fraction of IPRE1
1 - 3	1.87E+02	8.40E-01
3 - 6	3.08E+01	1.38E-01
6 - 9	3.83E+00	1.72E-02
9 - 13	9.21E-01	4.14E-03
13 - 15	4.02E-02	1.81E-04
15 - 16	4.34E-03	1.95E-05
16 - 18	7.24E-03	3.25E-05
18 - 19	1.20E-03	5.39E-06
19 - 21	1.57E-03	7.05E-06
21 - 22	4.04E-04	1.81E-06
22 - 24	3.86E-04	1.73E-06
24 - 25	1.33E-04	5.97E-07
> 25	2.73E-04	1.23E-06
Total	2.23E+02	1.00

Thus, approximately 84% of the initiating threats for Scenario 3 – 3 involve 14-day precipitation totals in the range of 1 to 3 inches, approximately 14% involve precipitation totals in the range of 3 to 6 inches, etc.

Trench Liquid Release and Dose Analyses

Section 8.4.3.1 describes the analyses that were performed to correlate the trench liquid overflow volumes, the corresponding leachate release rates, and the streamwater dilution flows for each range of incident precipitation that exceeds 1 inch.

Figure 13.2-17 shows the cumulative probability distribution for the conditional dose from Scenario 3 – 3. The major parameters of this distribution are summarized below.

Conditional Dose from Scenario 3 – 3 (mrem in 1 year)				
5th Percentile	Median	Mean	95th Percentile	Error Factor
0.98	28.9	295	824	29.0

There is large uncertainty in the estimated dose from this scenario. The mean value of the uncertainty distribution is slightly more than 10 times higher than the median value, which indicates that the upper end "tail" of Figure 13.2-17 has a significant impact on the overall results.

The uncertainty in the conditional dose from Scenario 3 – 3 is also influenced by the uncertainty in the radionuclide concentrations in the liquid that is released from the trenches. Section 9.2 describes the analyses that account for uncertainties in the concentrations of each radionuclide in the trench solids and uncertainties in the empirical distribution coefficients that are used to derive the liquid concentrations.

Potential Risk Improvements

The risk contribution from Scenario 3 – 3 accounts for the updated trench water level analyses described in Section 6.7 and the correlation between trench release rates and stream flows summarized in Section 8.4.3.1. Two potential improvements may reduce remaining sources of conservatism.

- The geomembrane damage analyses could be refined to evaluate the fraction of seismic events and the fraction of general aviation aircraft crashes that may cause sufficient SDA surface disruption to allow direct water infiltration.
- Analyses of leachate samples from each trench or further refinements to the empirical distribution coefficients used in this study may provide improved estimates for the concentrations of specific radionuclides in the trench liquid.

13.2.10 Additional Risk Contributors

After the first nine scenarios described in the preceding sections, no other release scenario individually accounts for more than 1% of the total SDA risk.

Table 13.2-1 shows that seismic damage, gully erosion, and landslide scenarios in Release Mechanism 4 contribute increasingly to the "low frequency / high consequence" end of the risk profile in Figure 13.1-1. The table shows that the mean doses from some of these scenarios can be quite significant. However, the release frequencies are extremely small, resulting in negligible contributions to overall site risk. "Intermediate frequency / intermediate consequence" scenarios in Release Mechanism 3 also contribute to the middle range of the risk spectrum.

Of course, if additional efforts and analyses conclude that the risk from the top nine contributors can be substantially reduced, the remaining scenarios will account for correspondingly larger fractions of an overall lower total site risk, and they may then merit more detailed attention.

Table 13.2-1. SDA Risk Scenarios (Page 1 of 3)							
Scenario	Mean Frequency (event / year)	Mean Dose (mrem in 1 year)	Mean Frequency x Dose [(mrem in 1 year) / year]	Fraction of Total Risk	Cumulative Fraction of Total Risk	Contributing Conditions	
1 – 2	4.57E-04	174.95	7.99E-02	2.97E-01	0.297	Groundwater, Level = ULT / WLT, ULT Lateral	
4 – 1c	5.84E-05	1096.01	6.11E-02	2.27E-01	0.524	Local Landslide or Seismic Damage 1, Level = Current / Low, Liquids	
4 – 1	5.93E-05	539.60	3.18E-02	1.18E-01	0.643	Local Landslide or Seismic Damage 1, Solids	
2 – 1	4.00E-05	683.01	2.73E-02	1.02E-01	0.744	Groundwater, Level = High, WLT Lateral	
1 – 3	3.12E-02	0.59	1.85E-02	6.88E-02	0.813	Groundwater, Level = Current, ULT Lateral	
3 – 4	2.51E-04	69.66	1.73E-02	6.44E-02	0.877	Overflow, Level = ULT / WLT, > 9 inches in 14 days	
1 – 4	3.33E-02	0.35	1.17E-02	4.36E-02	0.921	Groundwater, ULT-KRS	
1 – 1	4.00E-05	290.64	1.16E-02	4.32E-02	0.964	Groundwater, Level = High, ULT Lateral	
3 – 3	2.01E-05	294.57	5.44E-03	2.02E-02	0.985	Overflow, Level = High, Surface Disturbed, > 1 inch in 14 days	
4 – 1b	8.13E-07	2283.36	1.77E-03	6.58E-03	0.991	Local Landslide or Seismic Damage 1, Level = WLT / ULT, Liquids	
4 – 3c	8.65E-07	1187.35	1.17E-03	4.35E-03	0.995	Seismic Damage 2, Level = Current / Low, Liquids	
4 – 1a	7.12E-08	4749.39	3.23E-04	1.20E-03	0.997	Local Landslide or Seismic Damage 1, Level = High, Liquids	
4 – 3	8.79E-07	361.82	3.21E-04	1.19E-03	0.998	Seismic Damage 2, Solids	

Table 13.2-1. SDA Risk Scenarios (Page 2 of 3)

Scenario	Mean Frequency (event / year)	Mean Dose (mrem in 1 year)	Mean Frequency x Dose [(mrem in 1 year) / year]	Fraction of Total Risk	Cumulative Fraction of Total Risk	Contributing Conditions
3 – 5	9.93E-07	171.28	1.67E-04	6.22E-04	0.999	Overflow, Level = ULT / WLT, Wind or Tornado, > 9 inches in 14 days
3 – 7	4.79E-06	34.78	1.49E-04	5.56E-04	0.999	Overflow, Level = Current / Low, > 25 inches in 14 days
4 – 2c	6.89E-08	1096.01	7.92E-05	2.95E-04	0.999	Gully Erosion, Level = Current / Low, Liquids
3 – 6	9.75E-07	69.46	6.23E-05	2.32E-04	1.000	Overflow, Level = ULT / WLT, Surface Disturbed, > 9 inches in 14 days
4 – 2	7.00E-08	539.60	3.81E-05	1.42E-04	1.000	Gully Erosion, Solids
4 – 3b	1.20E-08	2740.03	3.75E-05	1.40E-04	1.000	Seismic Damage 2, Level = WLT / ULT, Liquids
4 – 4c	4.95E-09	2557.37	1.35E-05	5.00E-05	1.000	Global Landslide, Level = Current / Low, Liquids
4 – 3a	1.05E-09	5662.74	6.79E-06	2.53E-05	1.000	Seismic Damage 2, Level = High, Liquids
5 – 1	3.69E-07	18.18	6.66E-06	2.48E-05	1.000	Aircraft crash or meteorite
3 – 2	1.97E-07	14.38	2.79E-06	1.04E-05	1.000	Overflow, Level = High, Wind or Tornado
4 – 2b	9.58E-10	2283.36	2.30E-06	8.54E-06	1.000	Gully Erosion, Level = WLT / ULT, Liquids
3 – 1	1.99E-08	28.60	6.32E-07	2.35E-06	1.000	Overflow, Level = High, 24- or 48-Hour Storm
3 – 9	2.07E-08	34.78	5.57E-07	2.07E-06	1.000	Overflow, Level = Current / Low, Surface Disturbed, > 25 inches in 14 days

Table 13.2-1. SDA Risk Scenarios (Page 3 of 3)

Scenario	Mean Frequency (event / year)	Mean Dose (mrem in 1 year)	Mean Frequency x Dose [(mrem in 1 year) / year]	Fraction of Total Risk	Cumulative Fraction of Total Risk	Contributing Conditions
3 – 8	1.93E-08	34.78	5.33E-07	1.98E-06	1.000	Overflow, Level = Current / Low, Wind or Tornado, > 25 inches in 14 days
4 – 4b	6.89E-11	6028.08	4.41E-07	1.64E-06	1.000	Global Landslide, Level = WLT / ULT, Liquids
4 – 2a	8.39E-11	4749.39	4.18E-07	1.56E-06	1.000	Gully Erosion, Level = High, Liquids
4 – 4	5.03E-09	24.95	1.17E-07	4.34E-07	1.000	Global Landslide, Solids
4 – 4a	6.03E-12	9772.79	6.26E-08	2.33E-07	1.000	Global Landslide, Level = High, Liquids

Table 13.2-2. Geomembrane Unavailability, Trench Caps Intact, Quantification Parameter GEOMUI						
Contributor	5th Percentile	Median	Mean	95th Percentile	Fractional Importance	
Slope gully erosion	1.51E-03	5.80E-03	1.15E-02	3.69E-02	0.599	
Wildfire	1.73E-04	1.80E-03	3.17E-03	5.57E-03	0.165	
XR-5 planned replacement	2.22E-03	2.62E-03	2.60E-03	2.91E-03	0.135	
VLDPE planned replacement	1.12E-03	1.31E-03	1.30E-03	1.44E-03	0.068	
Gas pipeline fire	2.47E-05	2.33E-04	6.35E-04	2.34E-03	0.033	
Total			1.92E-02		1.000	

Table 13.2-3. Geomembrane Unavailability, Clay Caps Damaged, Quantification Parameter GEOMUD						
Contributor	5th Percentile	Median	Mean	95th Percentile	Fractional Importance	
Seismic acceleration ≥ 0.25 g	5.25E-06	3.02E-05	5.29E-05	1.69E-04	0.690	
General aviation aircraft crash	3.39E-07	5.62E-06	2.35E-05	8.73E-05	0.307	
Meteorite impact (≤ 0.3 -meter)	3.39E-09	2.52E-08	1.24E-07	5.55E-07	0.002	
Commercial aircraft crash	2.15E-08	5.98E-08	7.44E-08	1.74E-07	0.001	
Military aircraft crash	1.48E-08	4.66E-08	6.11E-08	1.53E-07	< 0.001	
Total			7.67E-05		1.000	

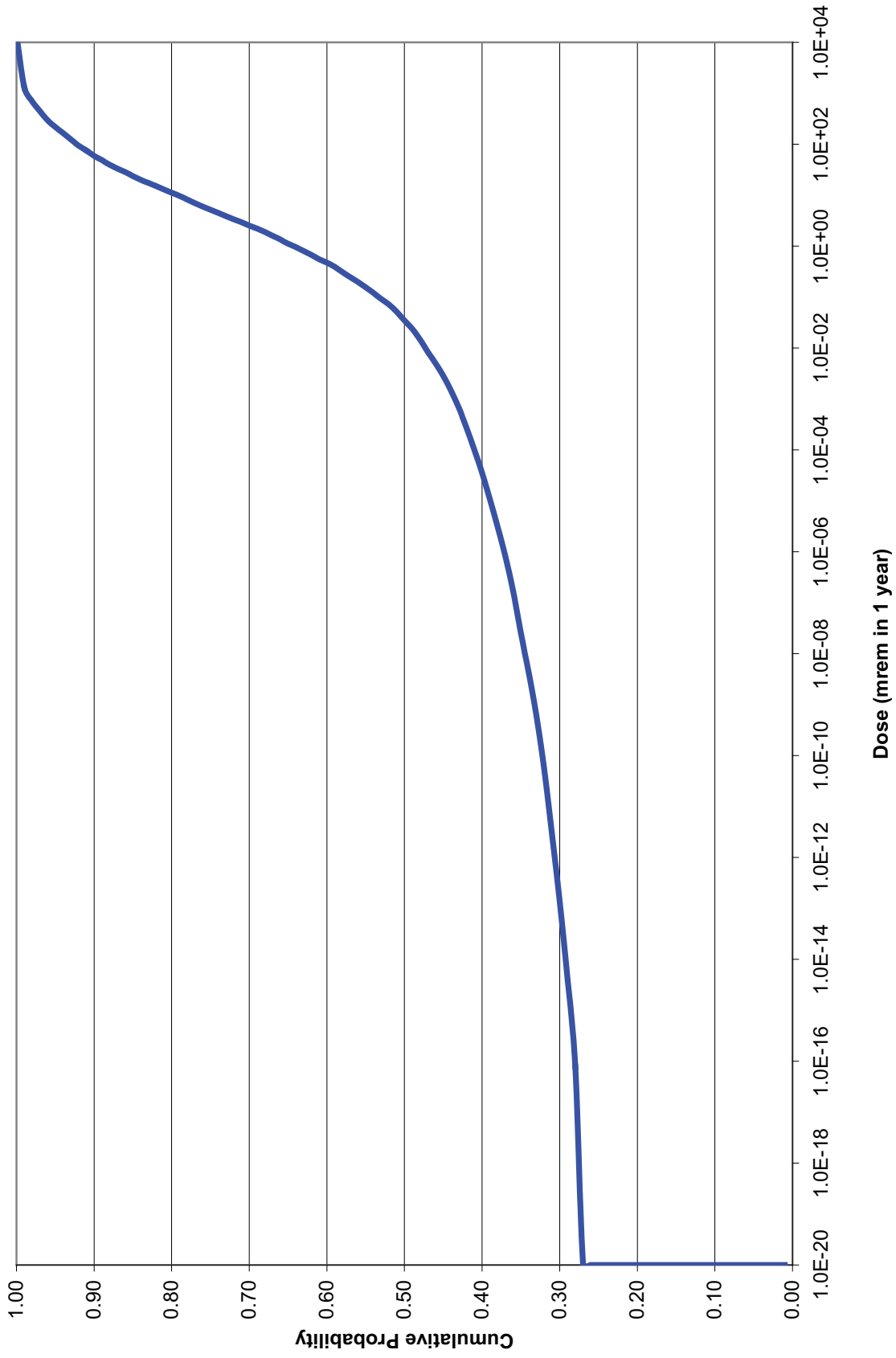

Figure 13.2-1. Uncertainty in Conditional Dose from Releases during Scenario 1 - 2

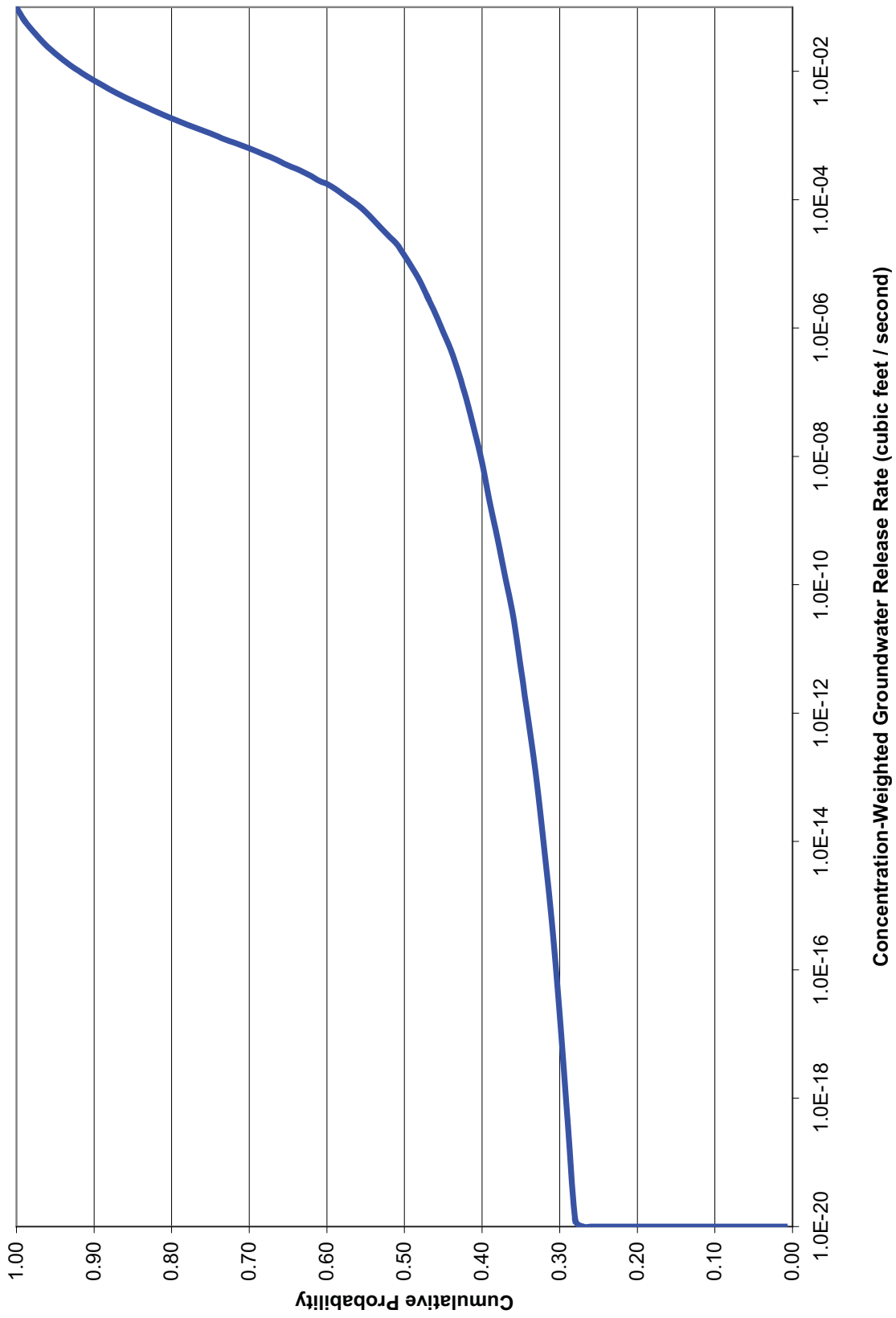

Figure 13.2-2. Uncertainty in Groundwater Releases during Scenario 1 - 2

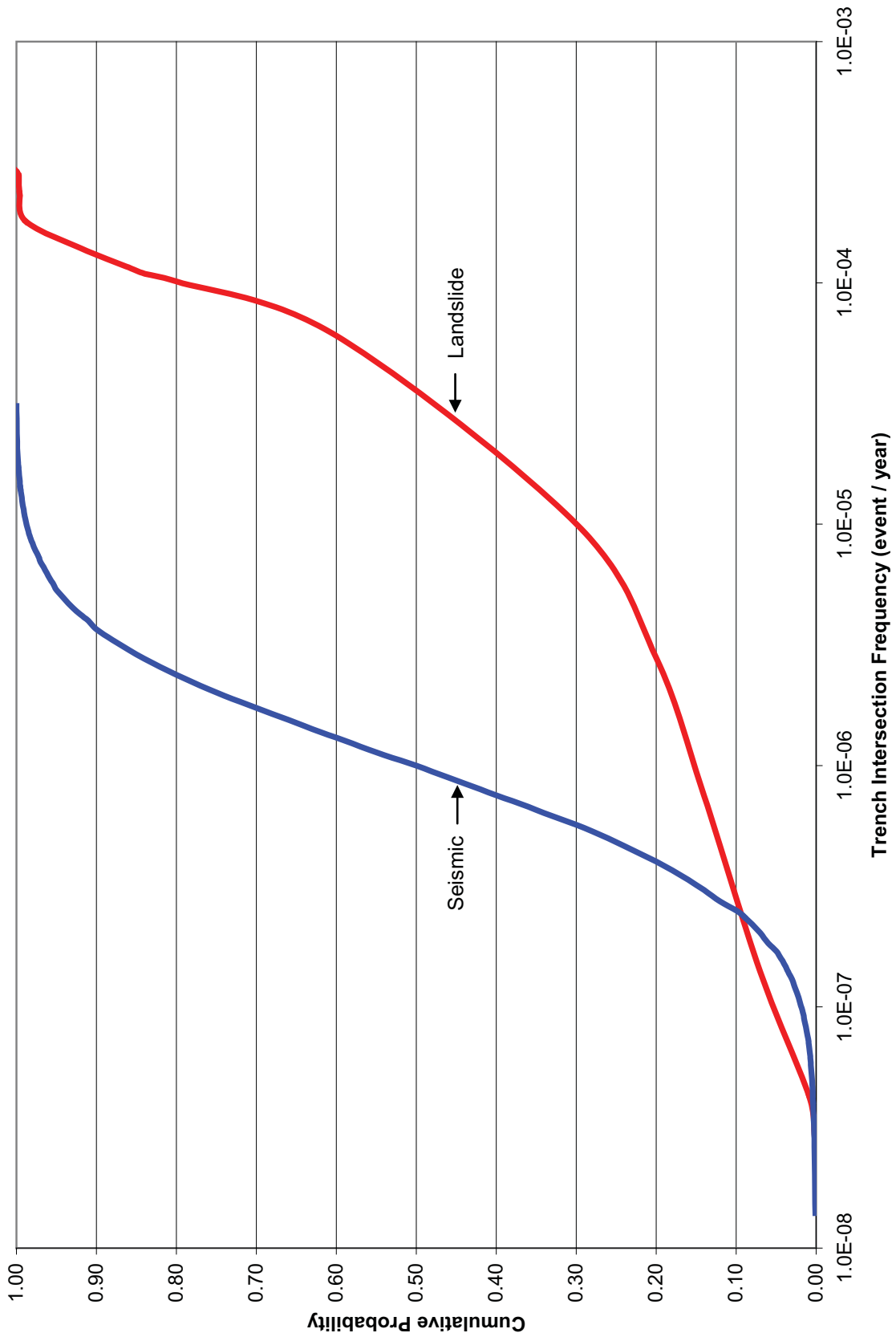

Figure 13.2-3. Uncertainty in Frequency of Localized Landslides and Seismic Damage Condition 1

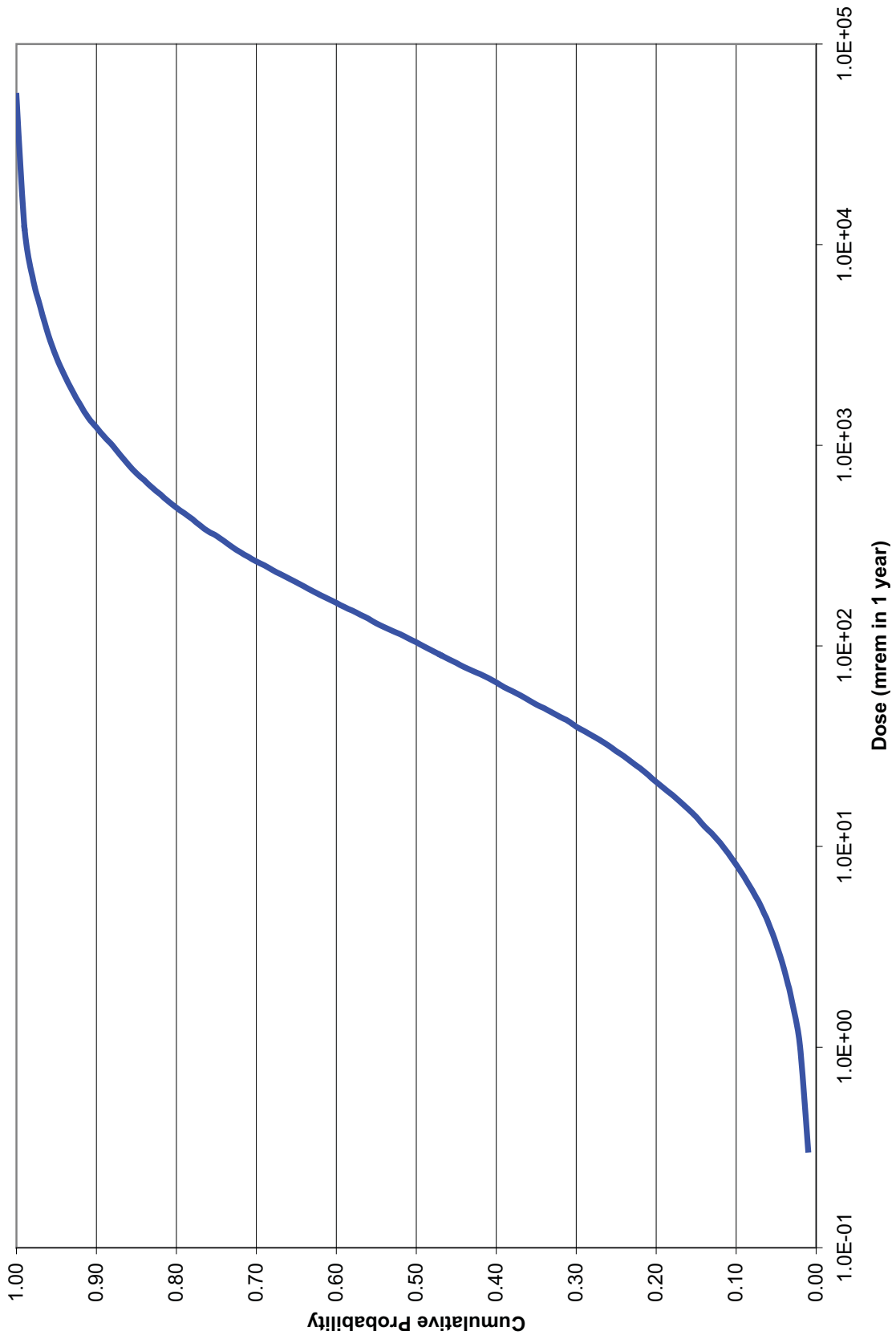

Figure 13.2-4. Uncertainty in Conditional Dose from Releases during Scenario 4 – 1c

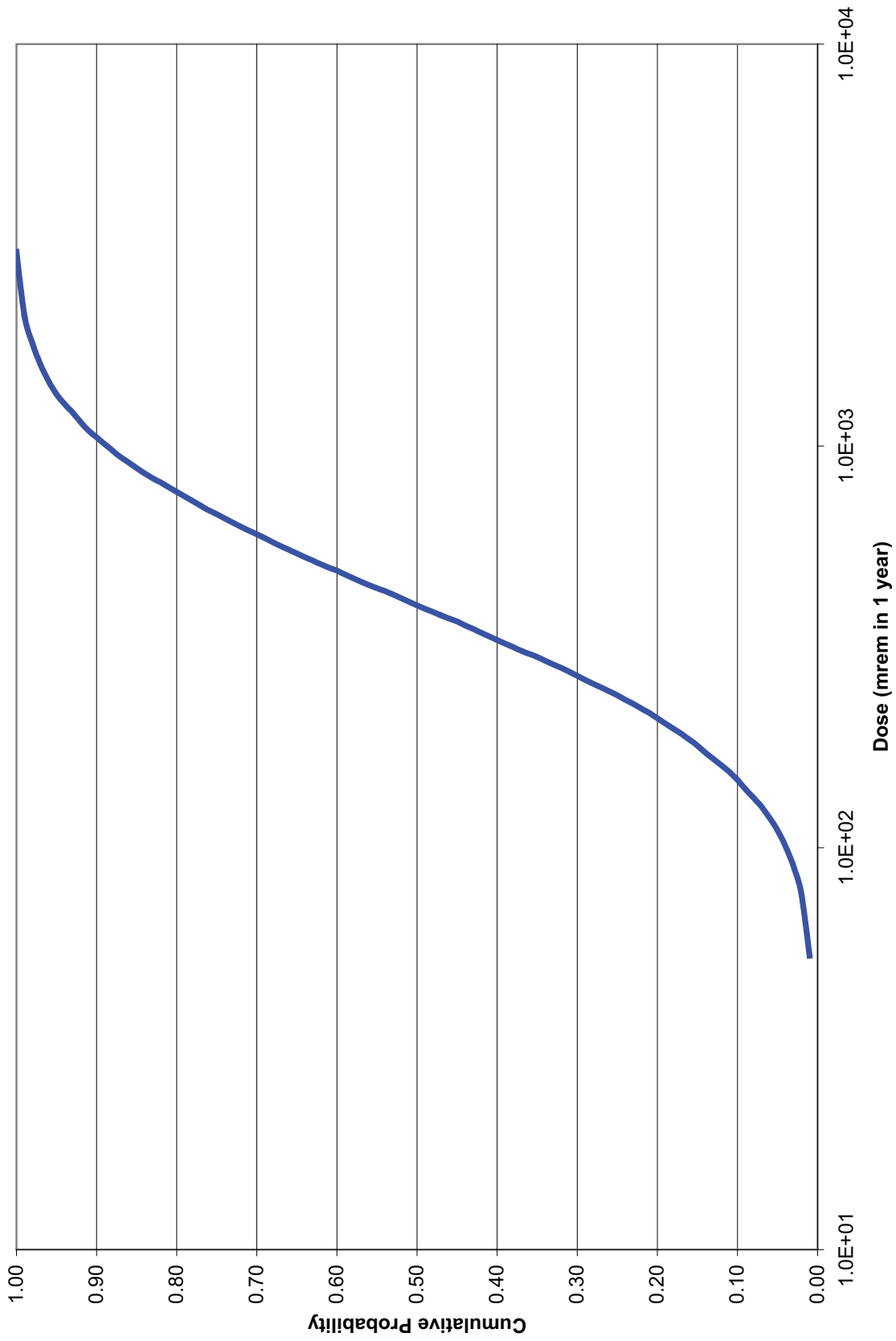

Figure 13.2-5. Uncertainty in Conditional Dose from Releases during Scenario 4 – 1

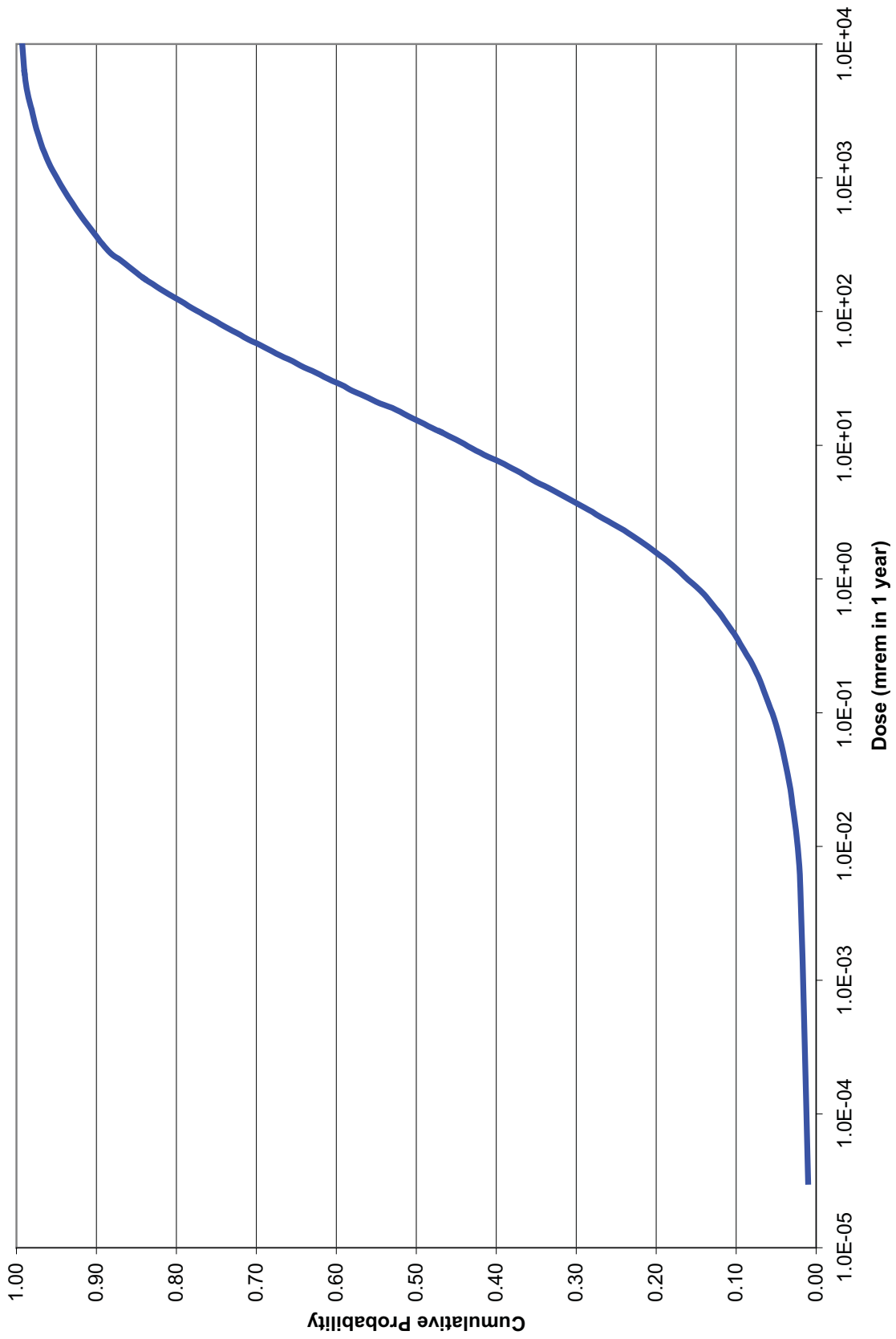

Figure 13.2-6. Uncertainty in Conditional Dose from Releases during Scenario 2 - 1

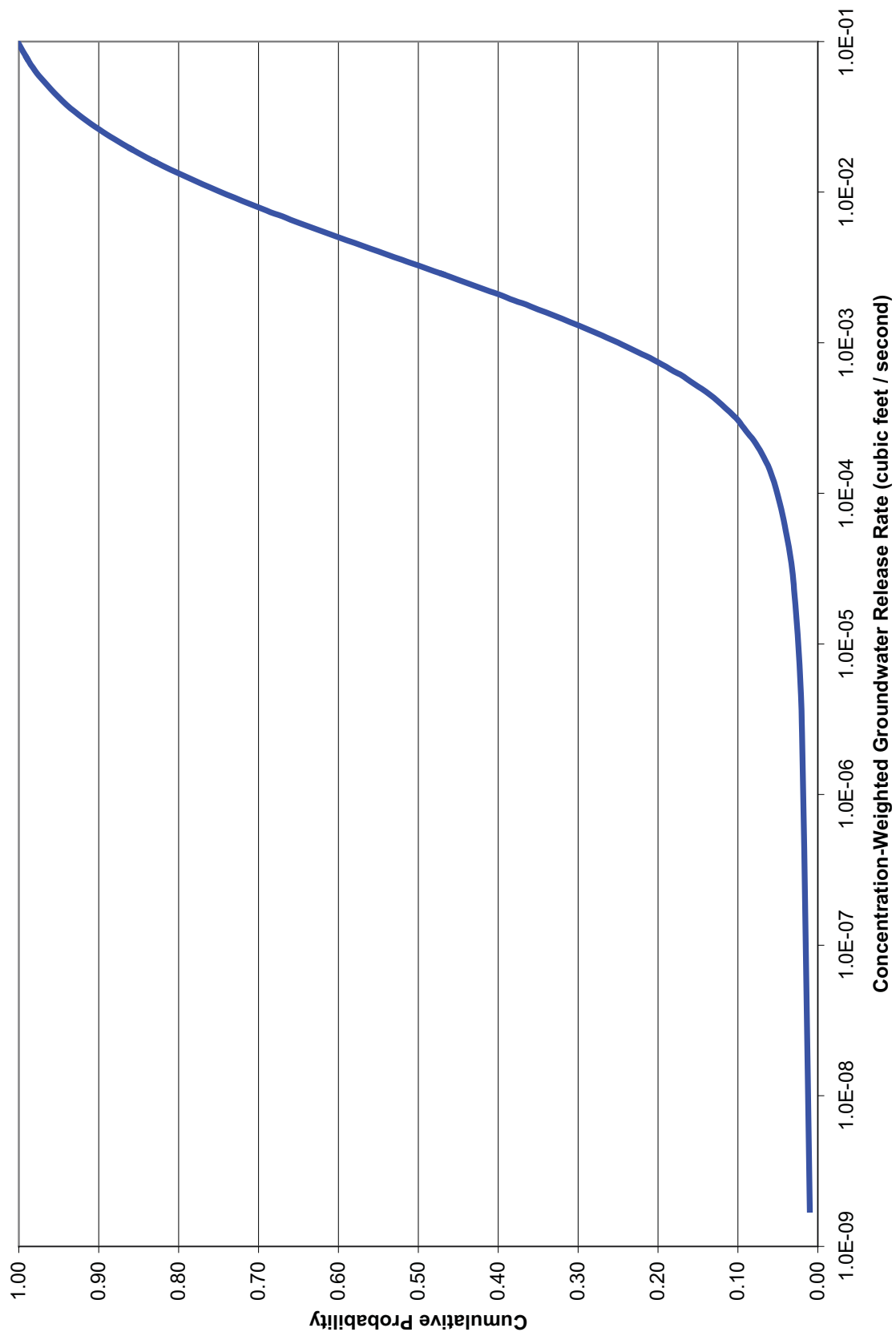

Figure 13.2-7. Uncertainty in Groundwater Releases during Scenario 2 - 1

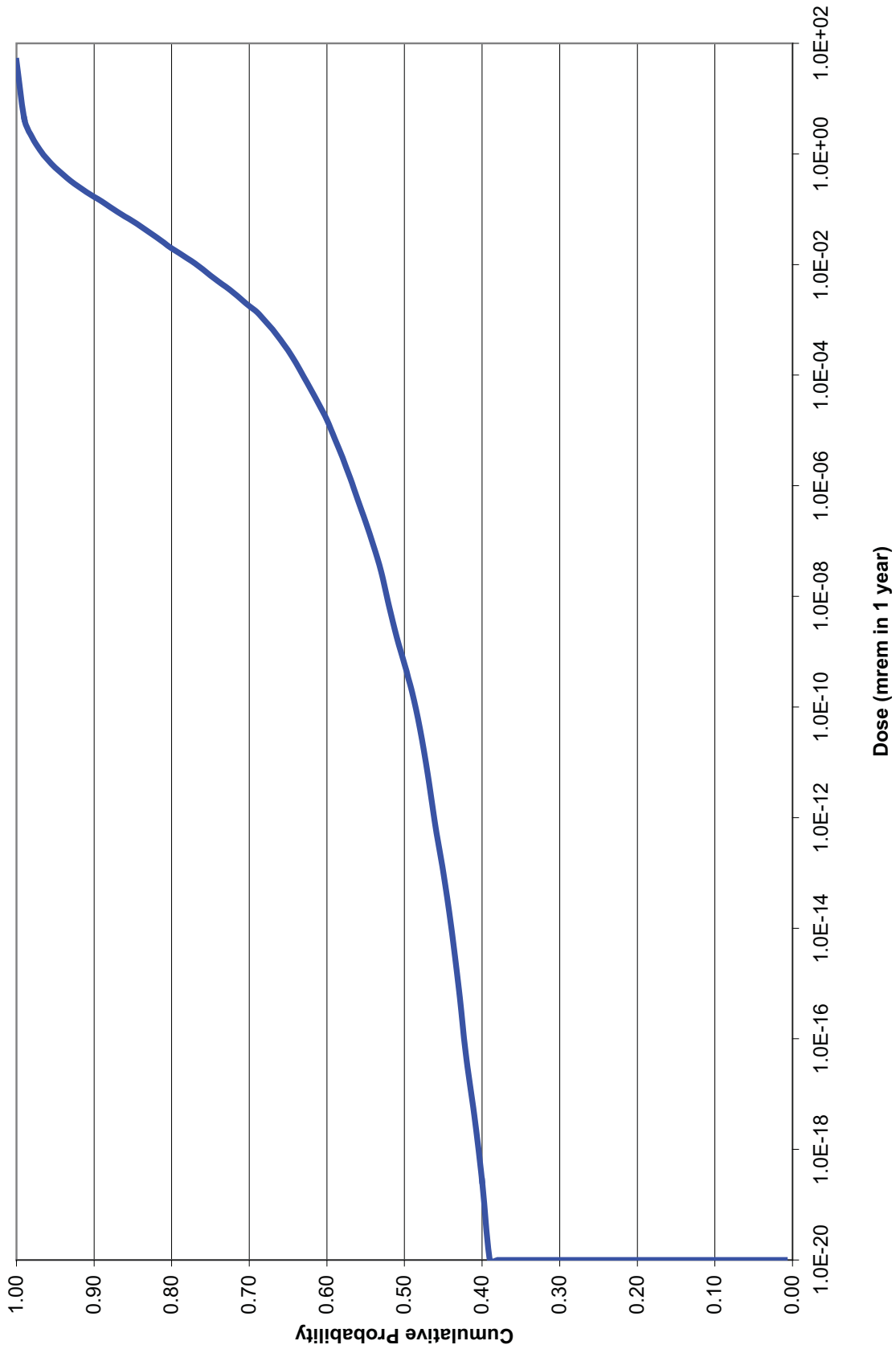

Figure 13.2-8. Uncertainty in Conditional Dose from Releases during Scenario 1 - 3

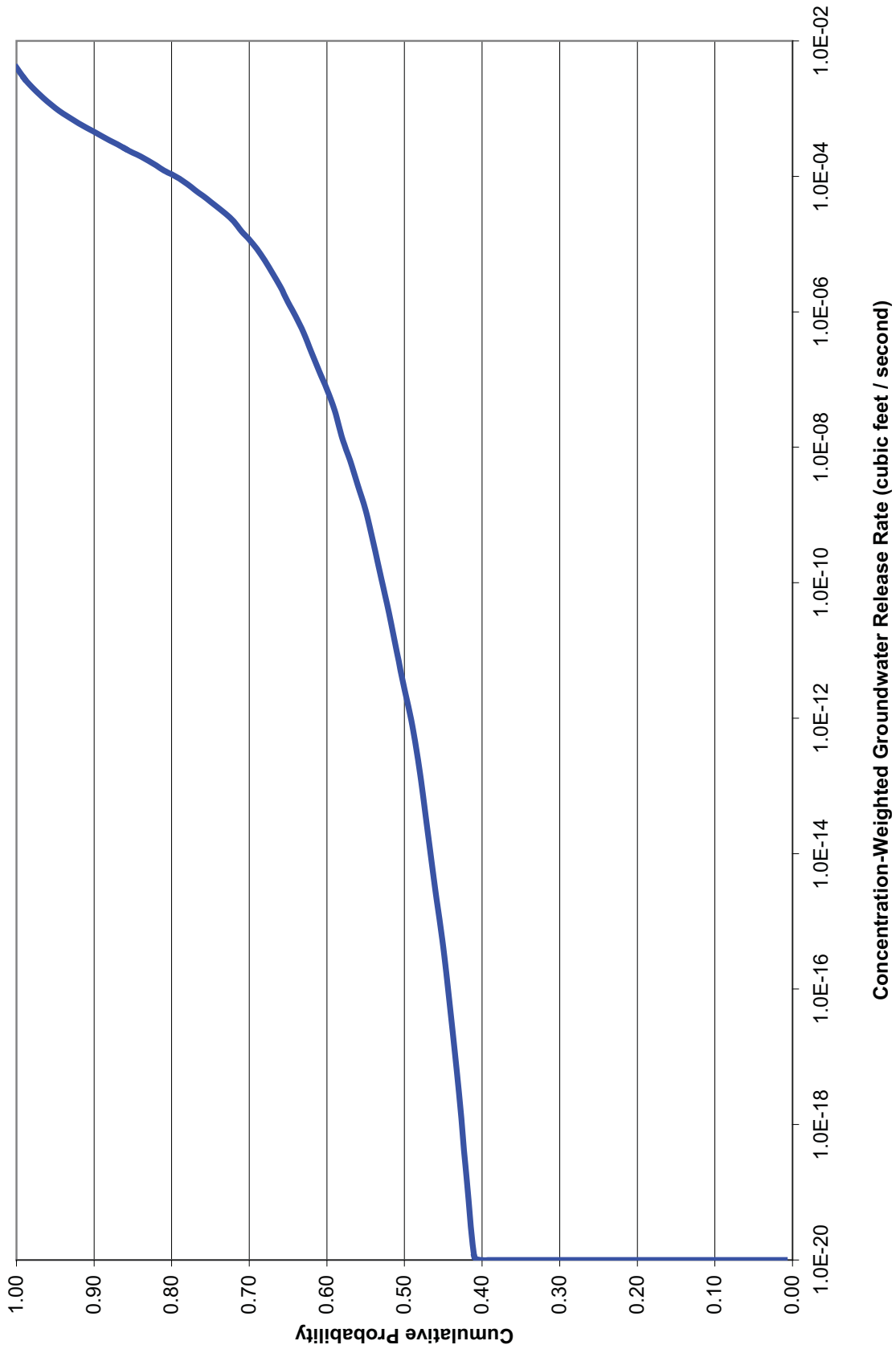

Figure 13.2-9. Uncertainty in Groundwater Releases during Scenario 1 - 3

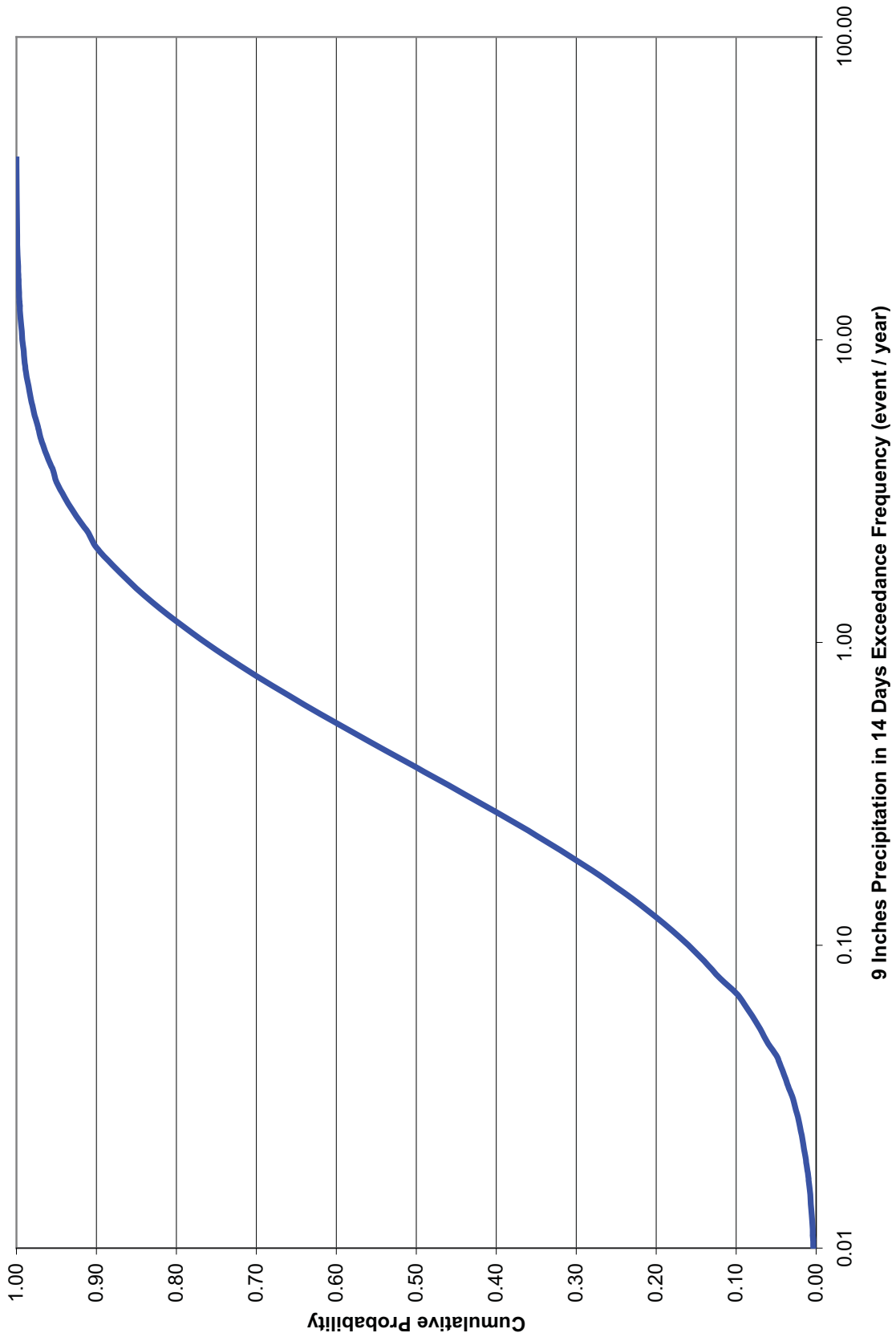

Figure 13.2-10. Uncertainty in Exceedance Frequency for 9 Inches Precipitation in 14 Days, Parameter IPRE9

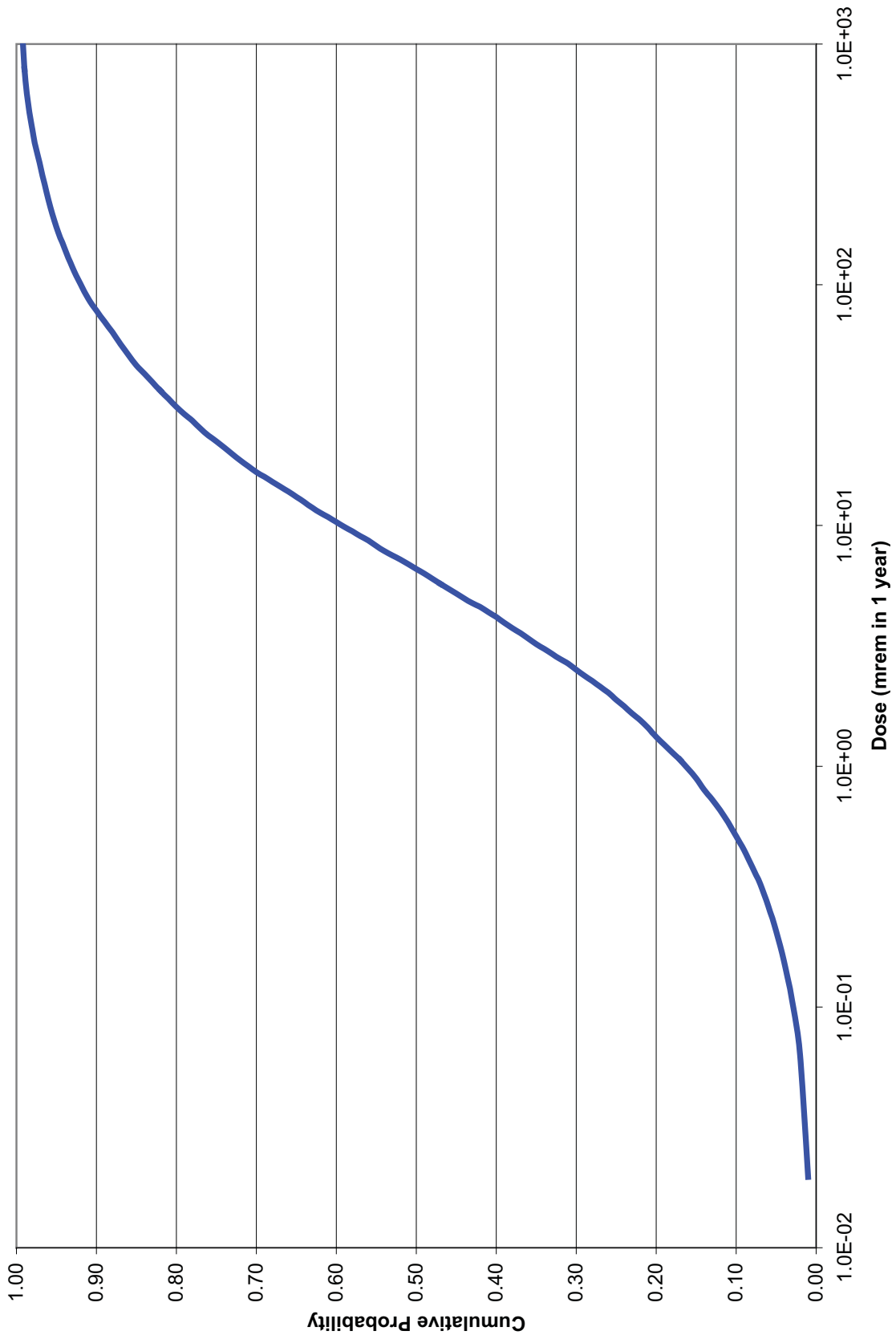

Figure 13.2-11. Uncertainty in Conditional Dose from Releases during Scenario 3 - 4

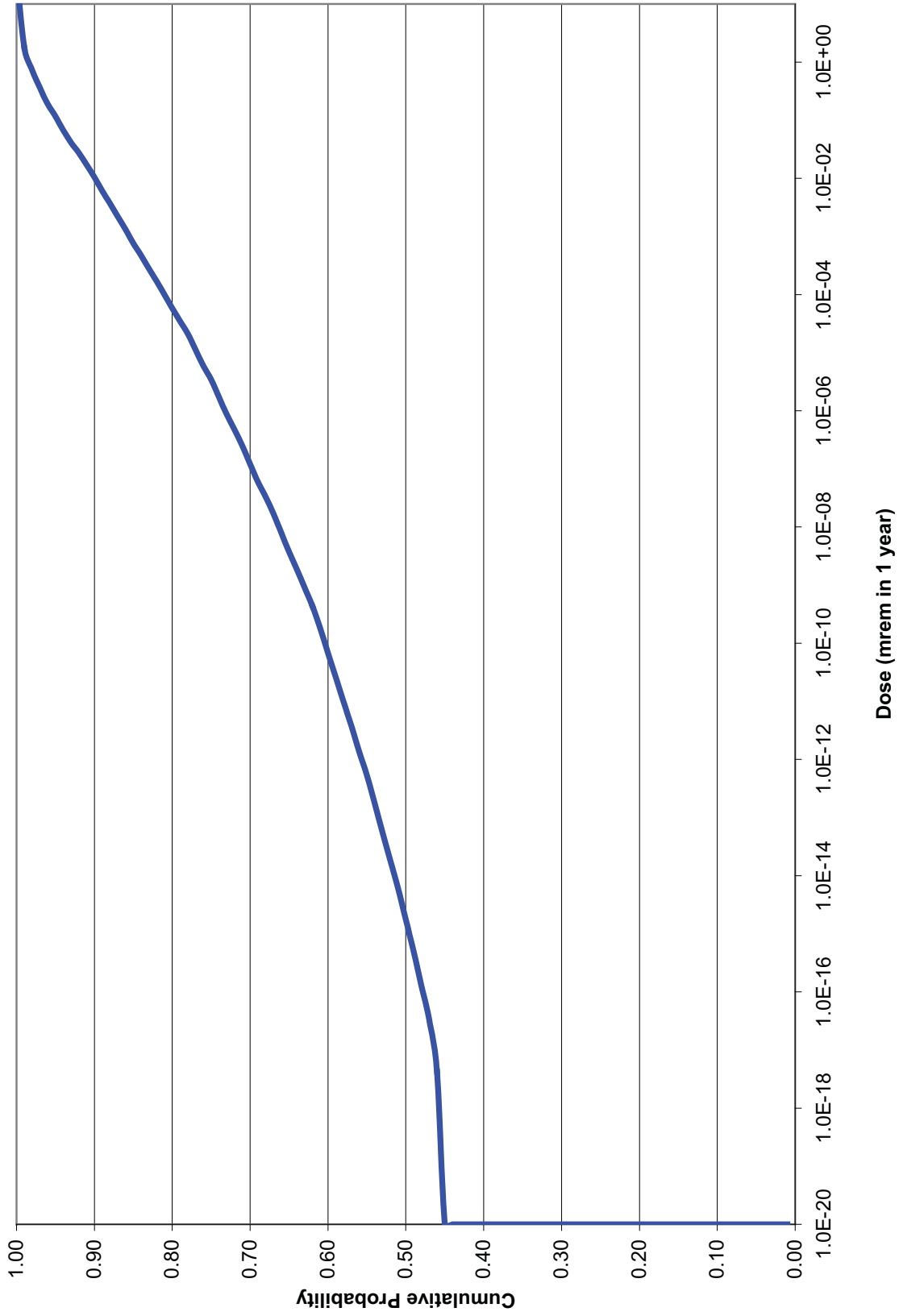

Figure 13.2-12. Uncertainty in Conditional Dose from Releases during Scenario 1 - 4

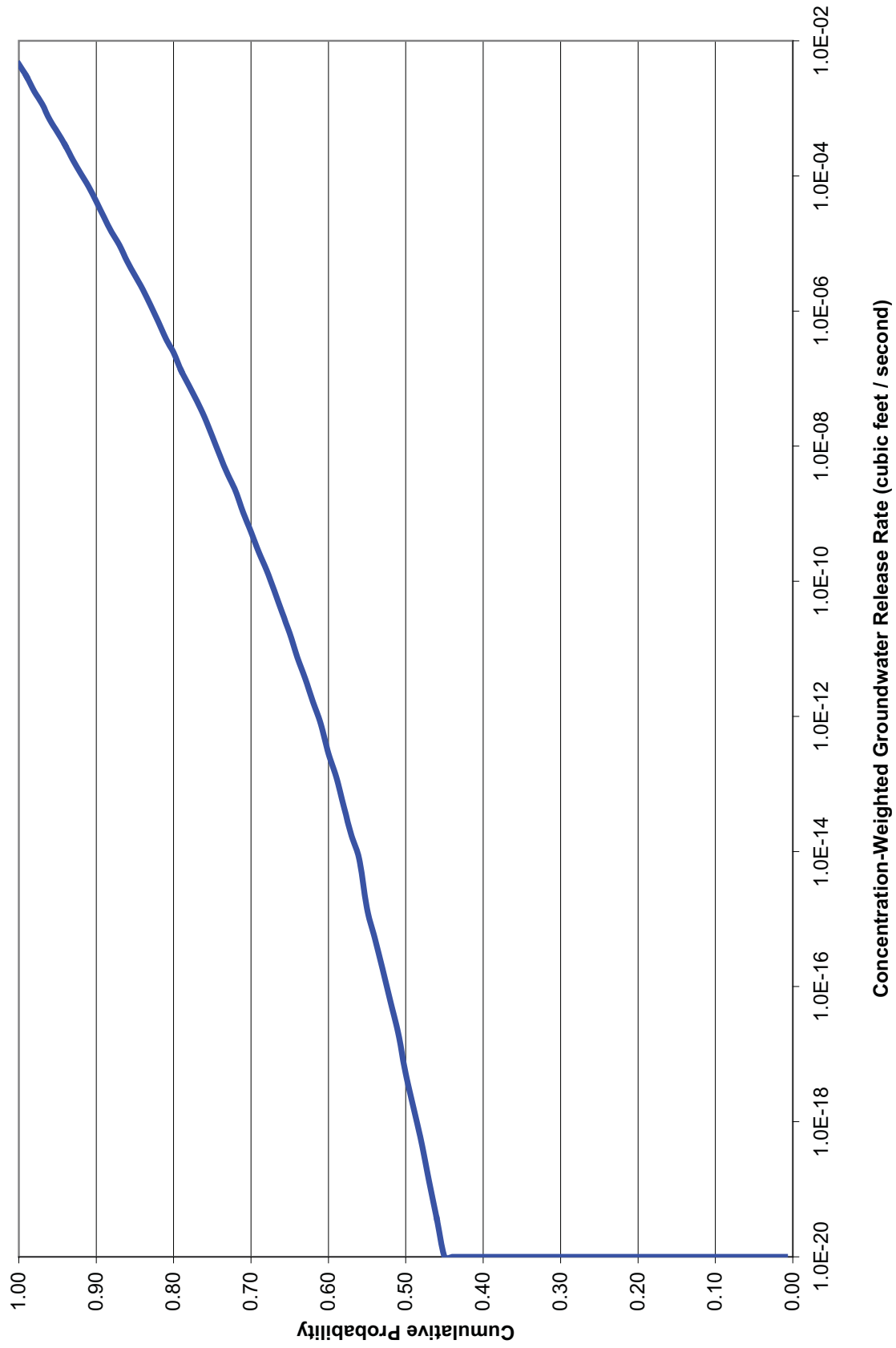

Figure 13.2-13. Uncertainty in Groundwater Releases during Scenario 1 – 4

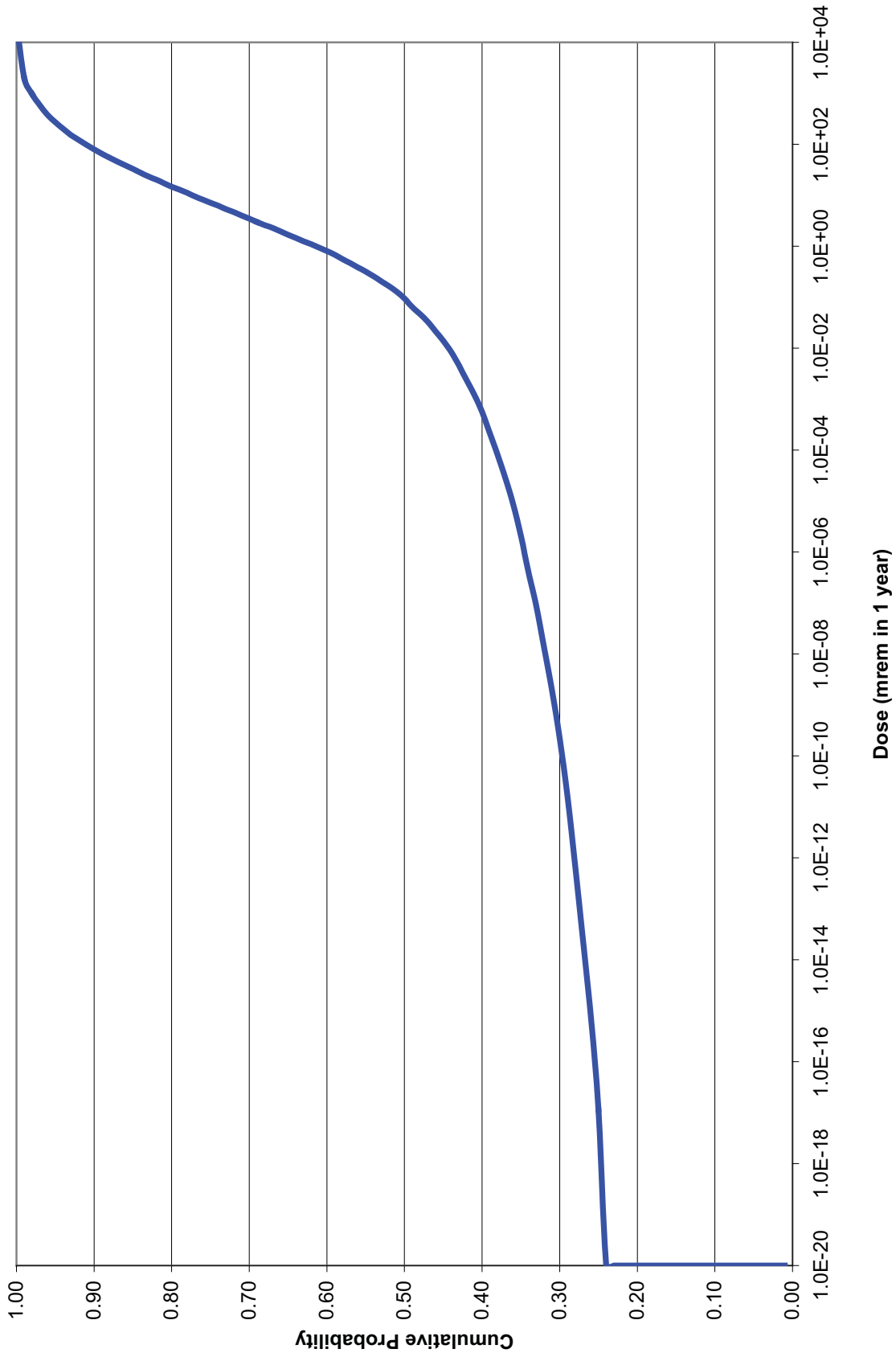

Figure 13.2-14. Uncertainty in Conditional Dose from Releases during Scenario 1 - 1

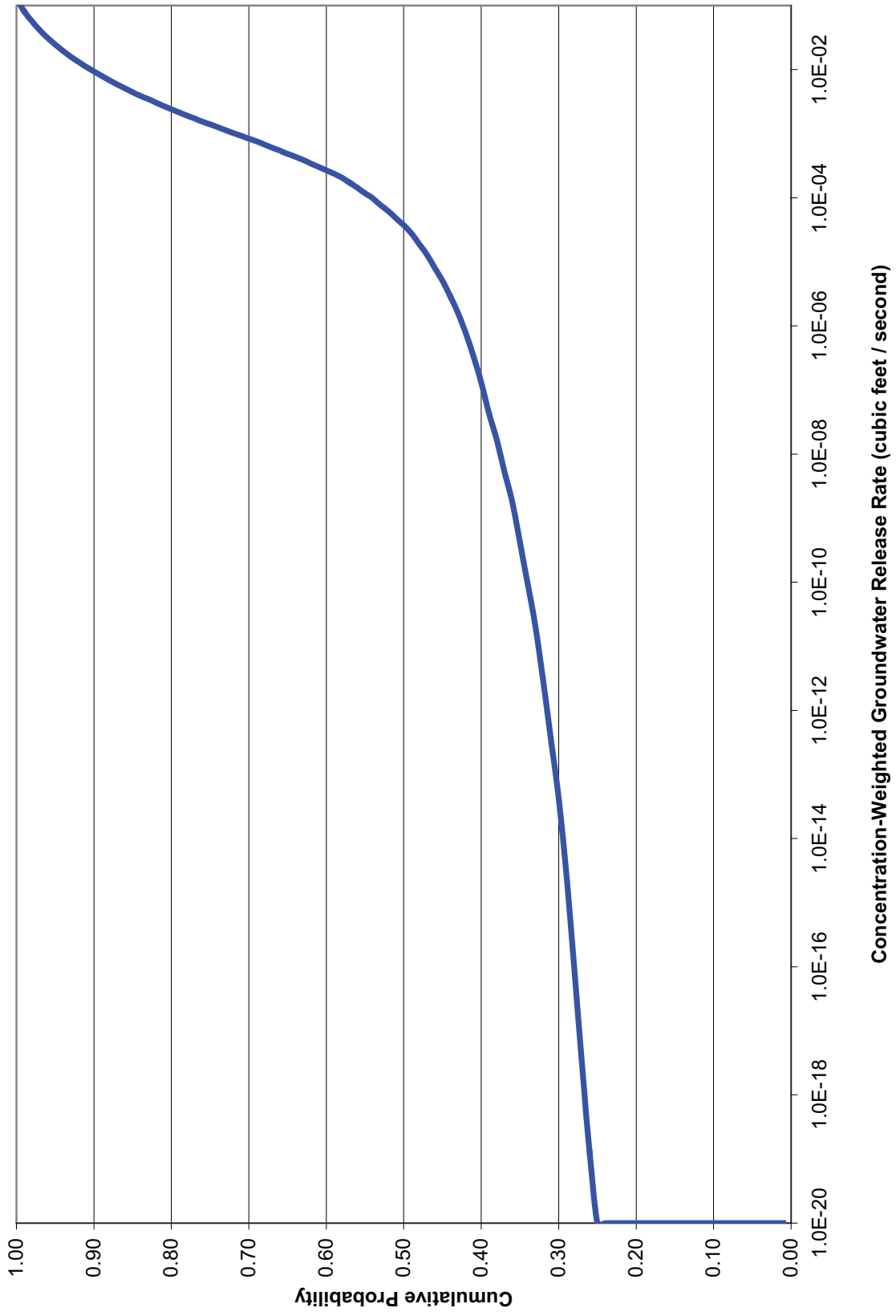

Figure 13.2-15. Uncertainty in Groundwater Releases during Scenario 1 - 1

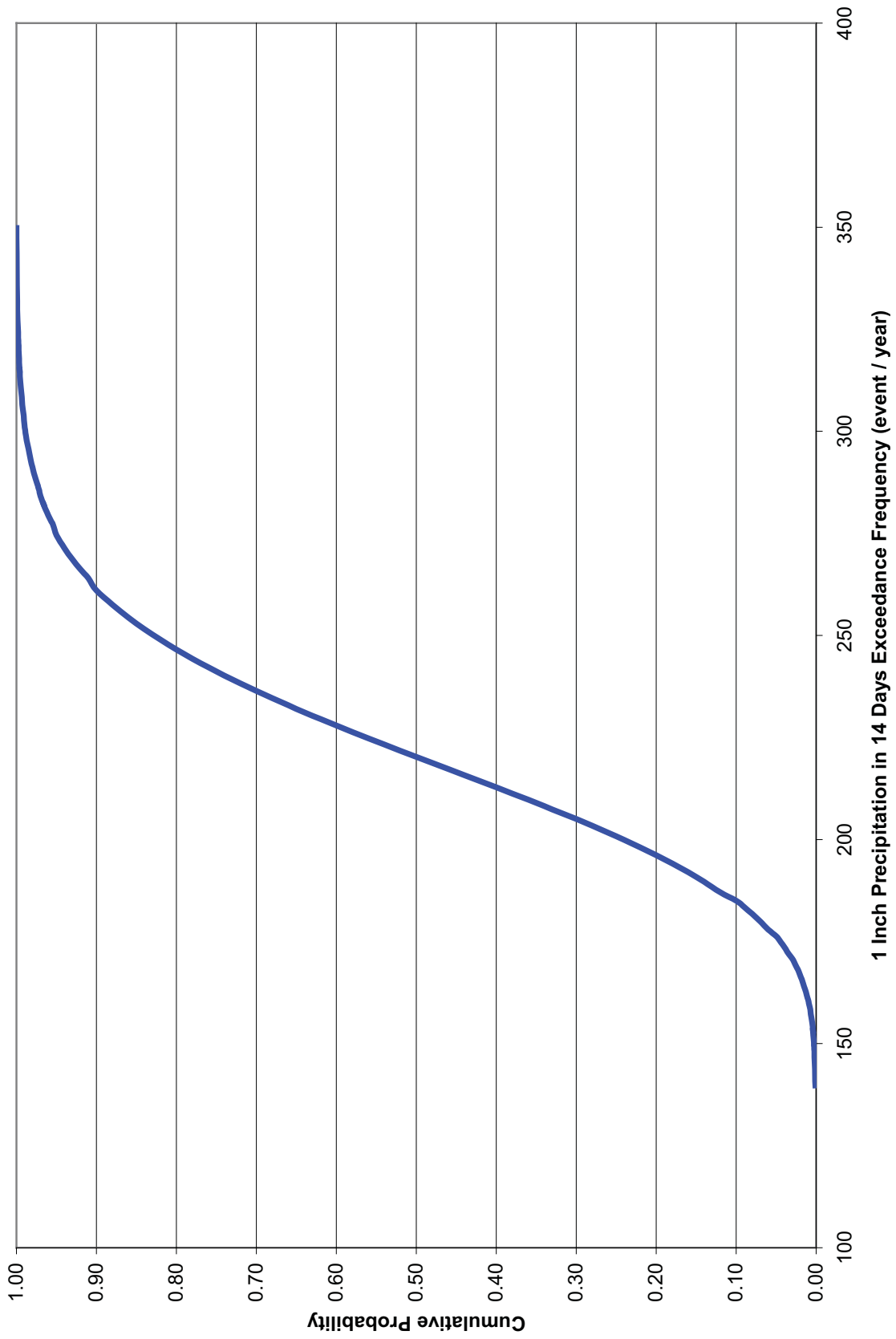

Figure 13.2-16. Uncertainty in Exceedance Frequency for 1 Inch Precipitation in 14 Days, Parameter IPRE1

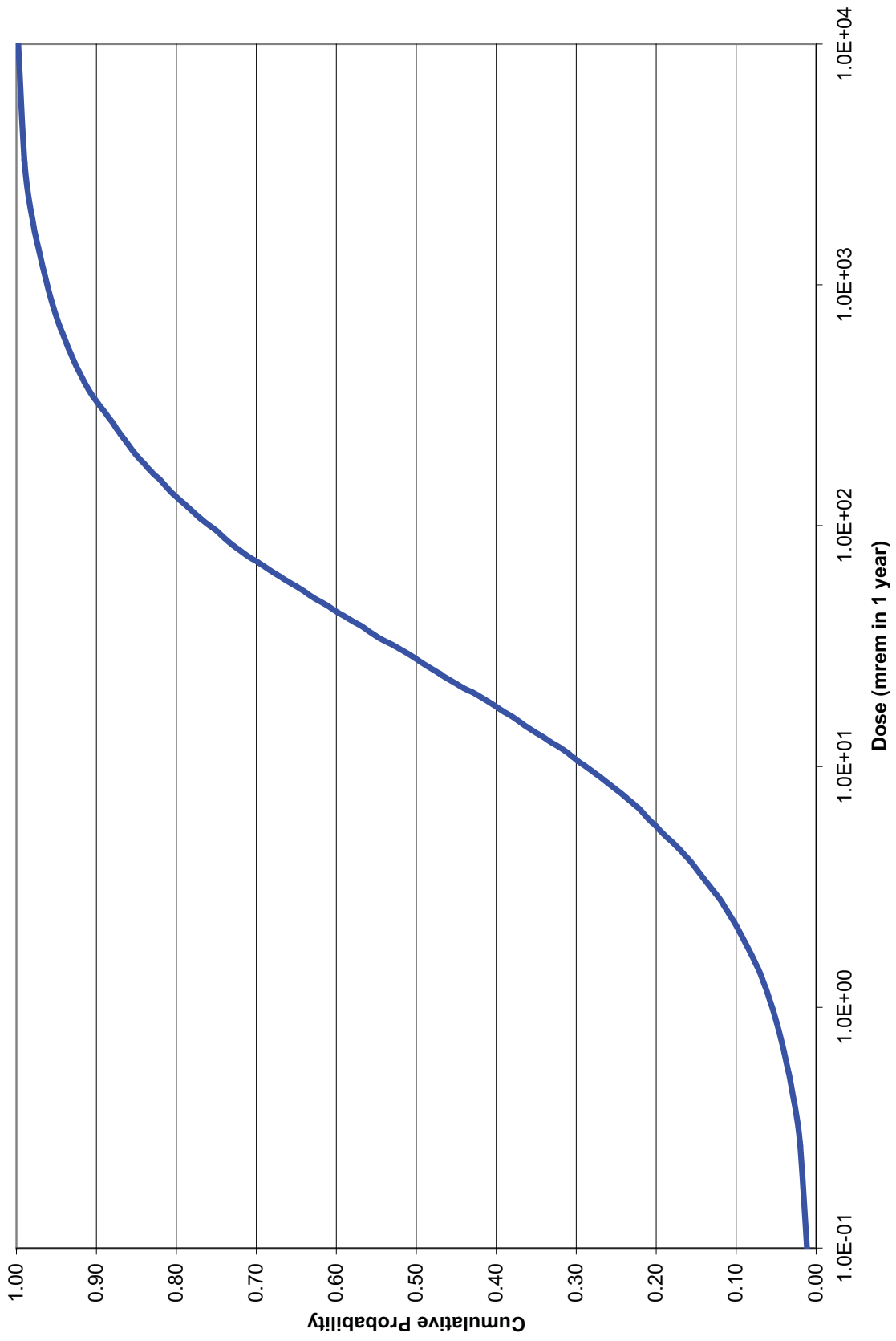

Figure 13.2-17. Uncertainty in Conditional Dose from Releases during Scenario 3 - 3

13.3 UNDERSTANDING THE UNCERTAINTIES

The preceding sections summarize the overall results from the SDA risk assessment and describe the most important contributing risk scenarios. Explicit quantification and display of the underlying uncertainties is a fundamental element of the QRA process. This section contains some illustrative examples that may facilitate better understanding and appreciation of the uncertainties in the results from this study.

As a specific example, we will examine the uncertainty for a "slice" through the SDA risk curves at the dose level of 100 mrem, or more, in one year. What do the study results tell us about this level of risk?

First, it is important to recall that this slice is characterized by the "probability of frequency" format that is used to quantify and display our uncertainty about the risk. In this context, we will answer the question – "How many release events will occur during the next 30 years that will result in a dose of 100 mrem, or more, to a member of the public?"

The complete answer to that question is represented by the uncertainty distribution that is shown in Figure 13.1-8. But what does "the answer" really tell us?

- The "expected" number of these release events in a 30-year period is 0.015 (the mean value of the uncertainty distribution). This value is also shown by the mean curve in Figure 13.1-7 at the dose "slice" of 100 mrem in one year.

Of course, we cannot experience a fraction of an event during the next 30 years. So what does this number mean? It is not correct to simply extrapolate the SDA operating time until we "accumulate" one release event, because many of the QRA supporting analyses and assumptions specifically account for the fixed 30-year study period. So, for example, this result does **not** mean that we would expect to have one release that produces a dose of 100 mrem, or more, if the SDA continues to operate for $[(1 / 0.015) * 30 =]$ 1,965 more years, because our particular risk assessment period extends only to the 30-year point. We have not evaluated how the site may change after 30 years, and we have certainly not examined the full range of possible conditions that may evolve over the next 2,000 years. What this risk result really means is that we would expect to experience one release that produces a dose of 100 mrem, or more, at some time during the next 30 years if we have a total population of about $(1 / 0.015 =)$ 67 sites that are precisely identical to the SDA.

This is the mathematically precise interpretation of the mean frequency for a release with consequences of 100 mrem, or more. However, despite its numerical rigor, it is admittedly somewhat confusing to characterize the risk from the SDA in terms of a population of identical sites that must operate for 30 years before we would expect to experience one release. So, in practice, QRA results are often presented in terms that are more intuitively meaningful to most people.

The most usual characterization is to simply report the mean value of 0.015 release in the 30-year period in terms of its equivalent annual frequency, or one event in approximately 1,965 years. As shown above, this characterization may be somewhat misleading, because we have not evaluated the actual risk beyond 30 years. However, because 1,965 years is much longer

than the planned 30-year SDA operating period, it is easy to understand that we do not "expect" to have a release with these consequences during the next 30 years.

Another occasionally used characterization is to state that there is approximately "1.5% chance" that we will experience a release from the SDA during the next 30 years. However, we now know that this "1.5% chance" is *not* a "1.5% **probability**" according to our understanding of the risk uncertainties. This value is simply the fraction of one release that is allocated to "our" SDA during the next 30 years. This characterization is generally discouraged, because it too easily confuses the fundamental concepts of probability, frequency, and fractional risk allocation.

- We have equal confidence that the number of these release events in a 30-year period is greater than, or less than, 0.014 (the median value of the uncertainty distribution). This value is also shown by the median curve in Figure 13.1-7 at the dose "slice" of 100 mrem in one year.

Continuing the discussion, this means that there is a "50 / 50 chance" that we would experience one release that produces a dose of 100 mrem, or more, at some time during the next 30 years if we have a total population of about $(1 / 0.014 =) 71$ sites that are precisely identical to the SDA. This value is slightly different from the "expected" (mean) result, because the uncertainty distribution in Figure 13.1-8 is not a symmetric bell-shaped curve. The non-symmetric shape of the curve results from the types of uncertainties that apply to each risk contributor and their propagation throughout the QRA analyses. The mean value is slightly higher than the median value because the long low-probability "tail" at the right end of Figure 13.1-8 includes scenarios with frequencies that are much higher than the median. The numerical effects from these rare "outliers" skew our uncertainty, but we must consistently account for them in our comprehensive assessment of the risk.

In the alternate method to characterize the results, we are 50% confident that the frequency of a release with consequences of 100 mrem, or more, is less than one event in approximately 2,105 years. We are also 50% confident that the frequency of these releases is greater than one event in approximately 2,105 years.

- We are 90% confident that the number of these release events in a 30-year period is between 0.012 and 0.019 (the 5th and 95th probability percentiles of the uncertainty distribution). These values are also shown by the 5th percentile and 95th percentile curves in Figure 13.1-7 at the dose "slice" of 100 mrem in one year.

This range represents our 90% confidence in the SDA risk results at this level of consequences. So, for example, we are 90% confident that we would experience one release that produces a dose of 100 mrem, or more, at some time during the next 30 years if we have a total population of between $(1 / 0.019 =) 52$ sites and $(1 / 0.012 =) 83$ sites that are precisely identical to the SDA.

Or, in the alternate characterization, we are 90% confident that the frequency of a release with consequences of 100 mrem, or more, is between one event in approximately 2,558 years and one event in approximately 1,567 years. This also means that we are 95% confident that the frequency is higher than one event in approximately 2,558 years, and we are 95% confident that the frequency is lower than one event in approximately 1,567 years.

- We are 95% confident that the number of these release events in a 30-year period is between 0.011 and 0.021 (the 2.5th and 97.5th percentiles of the uncertainty distribution).

These confidence bounds lie outside the range that is shown in Figure 13.1-7. For simplicity, we will now suspend the rigorous characterization of the risk results and retain only the alternate form. If we examine the uncertainties out to this confidence level, we can state that we are 95% confident that the frequency of a release with consequences of 100 mrem, or more, is between one event in approximately 2,611 years and one event in approximately 1,418 years. This also means that we are 97.5% confident that the frequency is higher than one event in approximately 2,611 years, and we are 97.5% confident that the frequency is lower than one event in approximately 1,418 years. The frequency of our lower confidence bound does not change very much as we extend the interval from 90% confidence to 95% confidence because the left side of the curve in Figure 13.1-8 is quite steep over this range. However, the low probability "tail" at the right side of the curve shows a much larger difference as we extend from the 95th percentile to the 97.5th percentile.

- We are 99% confident that the number of these release events in a 30-year period is between 0.011 and 0.060 (the 0.5th and 99.5th percentiles of the uncertainty distribution).

The 99.5th percentile of our uncertainty extends well beyond the right end of the plot in Figure 13.1-8. If we examine the uncertainties out to this confidence level, we can state that we are 99% confident that the frequency of a release with consequences of 100 mrem, or more, is between one event in approximately 2,670 years and one event in approximately 504 years. This also means that we are 99.5% confident that the frequency is higher than one event in approximately 2,670 years, and we are 99.5% confident that the frequency is lower than one event in approximately 504 years.

- We are "essentially certain" that the number of these release events in a 30-year period is between 0.011 and 0.091 (At least, within the numerical limits of our discrete version of the full probability distribution.)

These bounds are the smallest and largest values that are computed in the discrete representation of our uncertainty. It is not rigorously correct to state that there is zero probability that the number of events can be lower than 0.011, or there is zero probability that the number of events can be higher than 0.091. The actual underlying uncertainty distribution is a continuous function, and it does extend beyond these bounds. We simply cannot determine values very precisely outside this range with our computational tools. However, we do know that this range spans much more than our 99.8% confidence interval.

If we examine the uncertainties out to this confidence level, the best that we can state is that we are "extremely confident" that the frequency of a release with consequences of 100 mrem, or more, is between one event in approximately 2,695 years and one event in approximately 330 years.

So, in summary, this entire discussion is our current understanding of the "true" answer to the original question – "How many release events will occur during the next 30 years that will result in a dose of 100 mrem, or more, to a member of the public?"

In fact, we are quite uncertain about the precise answer to this question. The expected number of releases in 30 years is 0.015 (equivalent to one event in approximately 1,965 years). It could

be as high as 0.091 (one event in approximately 330 years) or as low as 0.011 (one event in approximately 2,695 years). However, we can state that we are:

- "Extremely confident" that it is less than 0.091 (one event in approximately 330 years),
- 99.5% confident that it is less than 0.060 (one event in approximately 504 years),
- 97.5% confident that it is less than 0.021 (one event in approximately 1,418 years), and
- 95% confident that it is less than 0.019 (one event in approximately 1,567 years)

SECTION 14

CONCLUSIONS AND RECOMMENDATIONS

This section highlights the principal technical conclusions from the SDA risk assessment and discusses a few recommendations from the QRA team.

14.1 CONCLUSIONS

The QRA results confirm that the public health risk from operating the SDA in its present configuration for the next 30 years is well below widely applied radiation dose limits, such as the 100 mrem per year limit specified under "Radiation Dose Limits for Individual Members of the Public" in Part 380 of the State of New York Codes, Rules, and Regulations (6 NYCRR Part 380) and in Part 20 of Title 10 of the Code of Federal Regulations (10CFR20). There is extremely high confidence that potential releases of radioactive materials from the SDA which may result in a 1-year dose to any member of the public of 100 mrem, or more, will occur much less often than once in 30 years.

These results should not be interpreted to mean that a release of this magnitude is impossible. They simply indicate that a release with these consequences is extremely unlikely during the next 30 years. If the SDA site could be maintained in its current state in perpetuity (including all geohydrologic and meteorological conditions) we would expect to experience this type of event only once in approximately 1,965 years.

This low level of risk will be maintained only if NYSERDA continues to operate the SDA according to its current physical and administrative controls.

The quantified risk from the SDA is dominated by a small number of event scenarios. A total of nine scenarios account for almost 99% of the overall risk. Five of these scenarios involve releases of radioactive liquids from the waste trenches through groundwater flow paths. Two scenarios involve trench overtopping and radioactive liquid releases via surface runoff during heavy precipitation that occurs while the geomembranes are not intact. Two scenarios are caused by localized landslides or seismic events that result in partial breaching of waste trenches near the site boundaries, with subsequent releases of contaminated solids and liquids.

The fractional risk contribution from each major release mechanism defined for this study is:

Release Mechanism 1: Groundwater flows through the Unweathered Lavery Till (ULT)	45.3%
Release Mechanism 2: Groundwater flows through the Weathered Lavery Till (WLT)	10.2%
Release Mechanism 3: Trench overflows and surface water runoff	8.6%
Release Mechanism 4: Trench breaches by erosion, landslides, and earthquakes	35.9%
Release Mechanism 5: Airborne releases from SDA physical impacts	<< 0.1%

In general, the occurrence frequencies for the scenarios that contribute to Release Mechanisms 1, 2, and 3 are higher than the frequencies of the scenarios that contribute to Release Mechanism 4. However, the potential doses from the scenarios in Release Mechanism 4 are typically much higher than the doses from Release Mechanisms 1, 2, and 3. Therefore,

Release Mechanism 4 accounts for slightly more than one-third of the total SDA risk, despite the low occurrence frequencies of those scenarios.

The risk contributions from Release Mechanisms 1, 2, 3, and liquid releases in Release Mechanism 4 are also influenced by the water levels in the waste trenches. These water levels have the following fractional risk contributions:

Water level does not affect the scenario risk:	16.3%
Levels at current elevations, or lower:	30.1%
Levels at the ULT / WLT interface:	36.9%
Levels near tops of trenches:	16.6%

The current trench levels are substantially below the ULT / WLT interface, and have been decreasing slowly. The QRA analyses conclude that there is slightly more than 98% probability that these conditions will be maintained throughout the 30-year SDA operating period. However, levels could increase, if the geomembranes are not properly maintained, if severe disruptive events damage the membranes, or if the SDA surface remains uncovered during planned membrane replacements. The sensitivity of the overall risk results to these increased water levels is apparent. The QRA analyses conclude that there is less than 2% probability that the two elevated water level conditions will occur during the next 30 years. However, despite that low probability, those conditions account for slightly more than 53% of the overall site risk.

There are very large uncertainties in the models, parametric data, and analyses that evaluate potential liquid releases through the groundwater pathways in Release Mechanisms 1 and 2. Those uncertainties contribute significantly to the quantified level of risk from those scenarios. In most cases, the mean (or "expected") consequences from the groundwater release scenarios are determined almost completely by low probability conditions that dominate the overall uncertainty and results.

14.2 RECOMMENDATIONS

There is very large uncertainty about several of the most important risk contributors identified in this study. The three most significant sources of uncertainty are:

- Models and analyses for the groundwater release pathways. Substantial reduction of these uncertainties may be achieved by extensive refinements to the groundwater flow models, supporting data, and analyses.
- Estimation of radionuclide concentrations in the trench leachate. These uncertainties may be reduced by further refinements to the QRA evaluations of the distribution coefficients for liquid concentrations of the most risk-sensitive radionuclides. Additional sampling of the trench leachate may also reduce these uncertainties. However, each trench contains a small number of sample points, and large variability has been observed in previously measured nuclide concentrations. Therefore, limited benefit may be realized from additional sampling with the sole purpose to reduce uncertainties in the estimated average nuclide concentrations in the trench leachate. Nonetheless, consideration of periodic monitoring of trench leachate concentrations for this and other purposes, such as assessment of trench water turnover rates, may be warranted.

- Evaluation of SDA slope stabilities and non-seismic slope failures. It is likely that these uncertainties can be reduced through further refinements to the slope failure models and the trench intersection probabilities.

The first two sources of uncertainty have compound effects for the liquid release scenarios in Release Mechanisms 1 and 2. The second source of uncertainty also affects all other liquid release scenarios. The third source of uncertainty affects the most important risk contributors from Release Mechanism 4. Relatively small reductions in the uncertainties may have a rather significant impact on the quantified risk, due to the numerical effects from low probability "tails" of the uncertainty distributions.

Apart from decisions regarding possible refinements to the QRA models, data, and analyses, it is recommended that NYSERDA should:

- Continue to monitor and, if necessary, actively maintain trench water levels below the ULT / WLT interface level, regardless of the status of the geomembranes and other activities at the site.
- Minimize the amount of time that the geomembrane covers are not intact, and the surface of the trench soil caps is exposed. This includes expedited repairs or replacement of damaged geomembrane sections, and minimizing the time and area of uncovered trench surfaces during planned geomembrane replacements.
- Formalize emergency preparedness plans and guidelines for responses to the types of release scenarios that are evaluated in this study. The risk from specific scenarios is affected significantly by the credit that has been applied for these intervention and mitigation responses.
- Consider the benefits from a program to periodically sample the water in each trench and monitor the concentrations of radionuclide species.

SECTION 15

PUBLIC COMMENTS AND REVIEWS

The September 25, 2008, draft of this report was made available to the public. Public meetings were also held to inform local citizens about the scope of the study, its methods, analyses, and results. During the intervening period, NYSERDA received comments regarding three general topics of concern that are addressed in this section. Section 15.1 provides an overview of the possibility of nuclear criticality in the SDA waste trenches. Section 15.2 discusses concerns regarding potential terrorist attacks and other intentional acts of destruction. Section 15.3 addresses the issue of climate change and how it might affect the study results.

15.1 CRITICALITY

Extreme care was exercised during the original preparation, packaging, shipment, and burial of wastes at the SDA to prevent the accumulation of sufficient quantities of fissile materials in a configuration that could support nuclear criticality. A previous study examined the following two hypothetical conditions that conservatively bound the likelihood for potential criticality.

- In-situ criticality within the SDA waste trenches, if fissile materials are present in a sufficient concentration and geometry with effective neutron moderation and reflection
- Mobilization, relocation, and deposition of sufficient quantities of fissile materials to form a potentially critical geometry

The study concluded that an in-situ critical geometry cannot be achieved at the SDA locations which contain the largest concentrations of fissile materials. The study also concluded that criticality due to mobilization, transport, and deposition of fissile material within 15,000 years is not a credible event.

The QRA team reviewed the earlier study and reconfirmed its conclusions, based on current data for the quantities and locations of fissile materials in the SDA trenches. Section 5.1.2.3 of this report summarizes those evaluations and concludes that potential nuclear criticality can be screened from further consideration in the SDA risk assessment.

15.2 TERRORISM

As noted in Section 3.6, the scope of this study does not include quantification of the risk from intentional acts of destruction, war, terrorism, or sabotage. Deterring the threat of terrorist attacks on U.S. targets has become a key element of national, state, and local security plans. Therefore, it is natural to question why deliberate attacks have been excluded from this study. This section discusses the issue of terrorism with respect to the SDA and provides a context for considering the potential risk from terrorist attacks.

Section 2 of this report describes the fundamental concept of the risk "triplet" that answers the following questions.

- What can happen?
- How frequently will it happen?
- What are the consequences if it does happen?

Considering the general threat of a potential terrorist attack, it is certainly possible to list a variety of conceivable attack scenarios. However, the physical characteristics of the SDA site and its security impose many practical constraints on the options that are available to a potential attacker. The QRA team does not believe that it is prudent to describe specific attack options or to discuss their relative merits in a publicly available report. However, it seems reasonable to assume that the most attractive options would involve a rapid attack using large amounts of explosives. The attacks could be ground-based, airborne, or a coordinated combination. Their common features would almost necessarily require a destructive method to rapidly disrupt the site and release radioactive material into the environment. This provides some useful perspectives on "what can happen".

With respect to the second question in the risk "triplet", it is first worthwhile to consider why a terrorist group might attack the SDA. Of course, detailed discussion of this topic is also problematic in a public report. It is useful to note that terrorist groups have historically preferred to attack high profile targets that are strong symbols of government, military, security, or public infrastructure. Of course, the anticipated direct consequences, public hysteria, fear, and media attention are also influencing factors. Although the SDA and its associated risks are the focus of this particular study and have thereby received increased attention, there is ample reason to believe that the SDA is not an attractive terrorist target.

Of course, the QRA team cannot claim that a terrorist attack on the SDA is "not credible". That assertion would be contrary to the fundamental principles of risk assessment. Therefore, a fully integrated quantitative assessment of the risk from terrorist attacks would need to answer the second question about "how frequently will it happen". This is the most difficult part of the analysis. It requires a realistic evaluation of the potential attack scenarios, their frequencies, and the associated uncertainties. That assessment would require substantial input from security organizations and experts who are familiar with terrorist capabilities, resources, and tactics. The QRA team again believes that it is not prudent to describe specific SDA attack scenarios, evaluate their potential likelihood of success, and estimate their occurrence frequency in a publicly available report. Therefore, we have not developed those scenarios, and we have not quantified the answer to the second question in the risk "triplet".

Despite the lack of a quantitative answer to the question of attack frequency, it is certainly possible to use the available knowledge and evidence to provide a degree of confidence about that answer. For example, security experts generally agree that terrorist groups are motivated primarily to attack high profile targets that combine elements of infrastructure vulnerability and immediate, sensational consequences. The SDA site certainly does not satisfy those requirements. The waste material is widely dispersed, and it is buried under several feet of compacted overburden. Even if the material were released, the quantities, activity levels, and very low local population density would not result in any significant immediate public health consequences. These observations are fully confirmed by the QRA results. Therefore, it is very difficult to postulate why a terrorist group would assemble and mobilize the substantial resources that are necessary to inflict damage on the SDA when the "payback" from that damage is minimal. That perspective is especially relevant, considering the multitude of much

more attractive targets that could be attacked using those same resources. For example, there are no known deliberate attempts of a terrorist attack on a nuclear reactor or a high level radioactive waste storage facility. If a nuclear target is appealing to a terrorist group, it is reasonable to think that a nuclear power plant or other reactor facility would be a first choice. Unlike a waste facility, a reactor has stored energy to assist in the dispersion of radioactive material, and it has a much higher public fear profile. A second choice for an attack would most likely be the site of a large inventory of high level radioactive waste (HLRW) such as onsite dry storage, spent fuel pools, nuclear weapon sites, shipments of HLRW or special nuclear material, or an interim storage site for HLRW. However, this would be a less attractive target than a nuclear reactor because of the absence of stored energy and its reduced public sensationalism. Thus, even within the potential realm of "nuclear targets", low level waste disposal areas such as the SDA rank very close to the bottom of any realistic attack priorities.

In summary, although the frequency of a terrorist attack on the SDA is not explicitly quantified in this study, that decision was influenced by the QRA team's confidence that such an attack is very unlikely, based on our current knowledge and the available evidence.

The SDA risk assessment models, supporting analyses, and results provide substantial information regarding the third question about "what are the consequences if it does happen". In particular, if it were successful, the type of attack that is considered in this section would have two consequences.

- An immediate direct release of airborne activity
- Destruction of the geomembranes and physical disruption of the SDA site and the trench clay caps

Scenario 5-1 in this study evaluates the dose from airborne activity releases that occur as a direct consequence from aircraft crashes and meteorite impacts. The results in Table 13.2-1 show that the mean dose from these direct releases is quite small. Therefore, the direct airborne activity released during a terrorist attack could be potentially important to the overall SDA risk only if the frequency of those attacks is very high.

The second consequence noted above generally has a more important impact on the overall SDA risk than the immediate airborne activity releases. Damage to the geomembranes and the clay caps leaves the trenches vulnerable to water intrusion from precipitation that occurs during the period until the covers are restored. The resulting hydraulic conditions affect essentially all of the other release mechanisms that are analyzed in this study.

The QRA team performed simplified sensitivity analyses to examine the integrated risk impacts from both the direct releases and the collateral effects from physical damage that may be caused by a terrorist attack. Those analyses indicate that the overall risk may increase by a factor of approximately 11 if there is a 10% probability of a successful attack on the SDA at some time during the 30-year period of this study. If the probability of a successful attack decreases to 1%, the overall risk may increase by only about 35%. There is a negligible impact on risk if the probability of a successful terrorist attack during the next 30 years is less than approximately 0.1%.

Thus, based on qualitative considerations regarding the likelihood of an attack and insights from the available QRA models and results, it is possible to conclude with reasonable

confidence that terrorism accounts for a very small fraction of the overall SDA risk, despite the lack of a fully integrated quantitative evaluation of the potential frequency of terrorist attacks.

15.3 CLIMATE CHANGE

This study contains a comprehensive assessment of the meteorology at the West Valley site and the surrounding region. The study evaluates risk contributions from severe storms, high winds, tornadoes, and extreme ranges of precipitation. Global evidence indicates that the Earth is currently experiencing a warming trend that is unprecedented in recorded history. Experts have postulated that this trend may cause dramatic changes in the North American climate and weather patterns, including disruption of ocean currents with increased frequencies and intensities of severe storms. Therefore, it is natural to question how these climate changes may affect the results from this study.

It is first important to recall that the time frame for this risk assessment extends only 30 years into the future. Therefore, the study does not address the effects from changes to the site that may occur over centuries or millennia. However, some experts note that the effects from global warming are already in progress and that regional climate changes may occur over a time scale of decades, rather than centuries.

15.3.1 Historic Weather Data

Sections 5.2, 5.3, and 5.4 of this report summarize the meteorological data that were compiled for this study. Records from the site and three regional weather reporting stations were used to develop detailed histories of precipitation rates and storm frequencies. The supporting databases contain approximately 86 years of daily weather records from the reporting station at Buffalo and approximately 82 years of records from the station at Dunkirk. Records of tornadoes in western New York, northwest Pennsylvania, and southern Ontario span 56 years.

The QRA team examined the meteorological data to investigate whether any trends are evident in either the frequency or the severity of storms in the West Valley region. There are certainly rather notable variations in the weather history. Figure 15.3-1 shows the annual precipitation at Buffalo, Dunkirk, and West Valley over each of the respective reporting periods. The records contain three very distinct spikes in the Buffalo precipitation data (1973-1974, 1993, and 1995). The QRA team confirmed that these deviations were not caused by extreme anomalies in the individual daily weather records. The team did not attempt to further investigate the reasons for these large perturbations. However, it is noteworthy that the weather data from Dunkirk and the West Valley site do not exhibit similar extremes in the same years. Therefore, it seems likely that the deviations may be attributed to local weather phenomena (e.g., lake effects). The Buffalo data also contain three years of very low precipitation (1967-1969) that are not mirrored by the Dunkirk records.

It is difficult to discern any consistent trend from the data in Figure 15.3-1. Average precipitation rates during the 1970's through the 1990's appear to be somewhat higher than the preceding five decades. However, precipitation rates seem to reduce again during the most recent decade. Of course, the averages are influenced considerably by the Buffalo data discussed above.

The QRA team also examined the daily weather records to investigate whether any trends are evident in the severity of individual storm events. Table 15.3-1 lists the top 20 daily precipitation records from each of the three reporting stations. Considering the fact that the West Valley data are available only for 1991 through 2007, there is no evident trend in the number of days with extremely high precipitation over the most recent several decades.

The historical data exhibit large variations in daily, annual, and location-specific weather among the three regional reporting stations. The analyses in this study explicitly account for the effects of these variations through the uncertainties that are evaluated for each meteorological parameter. For example, to preserve this important source of uncertainty, the data are intentionally not pooled or averaged among the reporting stations. Thus, the uncertainty analyses explicitly account for all of the variations shown in Table 15.3-1 and Figure 15.3-1. These uncertainties are displayed and quantified in the analysis of each contributing scenario, and they are propagated throughout the SDA risk integration process.

15.3.2 Sensitivity Analyses

It is unlikely that changes in the regional climate will have a significant impact on weather at the West Valley site during the next 30 years. In fact, it is likely that the quantitative impacts from any evolving climate changes will remain well within the uncertainties that are derived from the historical experience. However, to further examine the potential risk impacts from this issue, the QRA team performed several sensitivity analyses that evaluate the potential effects from increases in storm frequency and severity. The sensitivity analyses evaluate variations in the following meteorological conditions.

- High winds
- Tornadoes
- Precipitation

These conditions affect the following contributors to the SDA risk scenarios.

- Geomembrane unavailability
- Slope gully erosion
- Trench water levels
- Trench overflow

The trench water levels also have a secondary impact on the seismic and non-seismic slope failure analyses. For example, those analyses account for both water level and soil properties when evaluating the conditional likelihood of slope failure. However, the analyses performed in 2008 and 2009 confirm that these impacts are numerically very small over large variations in the trench water level probabilities. Therefore, the climate change sensitivity analyses do not re-evaluate those effects.

The sensitivity analyses set each meteorological parameter equal to the 95th percentile of its underlying uncertainty distribution. Thus, there is currently 95% confidence that the parameter value is less than this estimate. Depending on the degree of uncertainty, the mean (or expected) value for the parameter is typically much smaller than this 95% confidence bound. Considering the large uncertainties in the supporting meteorological data, the QRA team believes that this process provides a very conservative estimate for the potential effects that 30 years of climate change may have on the mean value for any parameter.

The following sections summarize the sensitivity analyses for each affected risk contributor and the integrated impacts on overall SDA risk.

15.3.2.1 Geomembrane Unavailability

Unavailability of the geomembranes is evaluated in Section 7.2 of this report. Table 7.2-1 lists the following frequencies for meteorological events that may damage the geomembranes.

Geomembrane Threat	Frequency (event / year)	
	Mean	95th Percentile
Wind gusts \geq 115 mph	1.23E-06	4.42E-06
F2 tornado impact	3.26E-05	1.43E-04
F3 tornado impact	4.39E-05	1.93E-04
F4 tornado impact	6.45E-05	1.54E-04
F5 tornado impact	2.06E-05	6.60E-05
Slope gully erosion	1.64E-02	5.22E-02

Use of the 95th-percentile frequency for each threat has the following impact on unavailability of the geomembranes.

Risk Model Parameter	Geomembrane Unavailability	
	Nominal Mean Value	Sensitivity Results
GEOMUI	1.93E-02	4.46E-02
GEOMUA	1.95E-02	4.50E-02

The sensitivity results are affected most by increased erosion of the slope gullies that intersect the East boundary of the site.

Table 12-1 shows that parameter GEOMUI contributes to risk Scenarios 3-1, 3-4, and 3-7. Parameter GEOMUA contributes to Scenarios 4-2, 4-2a, 4-2b, and 4-2c. Geomembrane unavailability parameter GEOMUD contributes to Scenarios 3-3, 3-6, and 3-9. However, that parameter is not affected by these particular meteorological conditions.

15.3.2.2 Slope Gully Erosion

The gully erosion that is evaluated in Section 15.3.2.1 may damage the engineered drainage systems and the geomembrane anchors near the site boundary, but it does not breach any of the waste trenches. Section 8.5.3.3 of this report describes the analyses of slope gully erosion that is severe enough to breach the trenches. This damaging erosion is caused by very intense precipitation that occurs during a 24-hour to 48-hour storm. The 95th-percentile precipitation

exceedance frequencies for these storms were convoluted with the gully erosion fragilities to produce the following result.

Risk Model Parameter	Trench Breach Frequency (event / year)	
	Nominal Mean Value	Sensitivity Results
GULLER	3.76E-06	1.31E-05

Scenarios 4-2, 4-2a, 4-2b, and 4-2c evaluate the risk from releases that are caused by this gully erosion.

15.3.2.3 Trench Water Levels

Water levels in the trenches are an important input to several analyses in this study. Section 6.7 of this report evaluates the probabilities for four discrete level conditions that may apply during the 30-year study period. Those analyses are affected by severe storms that may damage the geomembranes and expose the trench surfaces to incident precipitation (e.g., conditions like those evaluated in Section 15.3.2.1). The analyses are also affected by cumulative precipitation that occurs during periods when the trench surfaces are exposed due to other types of disruptive events that damage the geomembranes, or during planned geomembrane replacement periods.

Section 15.3.2.1 lists the 95th-percentile frequencies that apply for high winds and tornadoes that may damage the geomembranes.

The precipitation exceedance data applied in Section 6.7 are conservatively derived from the maximum of the three relevant weather reporting stations (i.e., Buffalo, Dunkirk, and West Valley). For these sensitivity analyses, it is assumed that the applied data are the mean values of the underlying uncertainty distributions. This is conservative, because the actual mean value will always be lower than the nominal applied value, accounting for the observed variability in the weather station data. The following numerical factors are then used to scale the (assumed) mean values to the corresponding 95th percentile values.

Range of Mean	Approximate Lognormal Error Factor	Mean to 95th Percentile Scaling Factor
1E-02 to 1.0	3	2.5
1E-03 to 1E-02	5	3
1E-04 to 1E-03	7.5	3.5
1E-05 to 1E-04	15	4
1E-06 to 1E-05	25	4.5

The scaling factor of 4.5 for the lowest range is actually much larger than would apply for a lognormal error factor of 25. However, it is used for conservatism in the sensitivity analyses to account for very large uncertainties at these low precipitation exceedance values.

As an example of this scaling process, the analyses in Section 6.7.4.1 show that a nominal exceedance probability of 3.58E-05 applies for cumulative precipitation that exceeds 36.8 inches in 46 days. This value was derived from the Buffalo weather data that are summarized in Table 6.7-3 and Figure 6.7-1. For the sensitivity analyses, this exceedance probability is increased by a scaling factor of 4 to (4 * 3.58E-05 =) 1.43E-04.

These changes affect the trench water level probabilities as follows.

Trench Water Level	Nominal Probability	Sensitivity Results
Trench Tops	0.0012	0.0009
WLT / ULT Interface	0.0137	0.0270
March 2008 Benchmark	0.9351	0.9221
Trench Bottoms	0.0500	0.0500

The sensitivity analyses result in a lower probability that water levels are at the tops of the trenches, compared with the analyses in Section 6.7. This occurs because the higher precipitation increases the probability that the trenches will overflow, rather than levels stabilizing between the WLT / ULT interface and the trench tops. Thus, some of the nominal precipitation conditions in Section 6.7 that result in High trench levels effectively transition to overflow cases for the sensitivity analyses.

Table 12-1 shows that the trench water levels affect all risk scenarios in the study, except Scenarios 1-4, 4-1, 4-2, 4-3, 4-4, and 5-1.

15.3.2.4 Trench Overflow

Section 8.4 of this report describes the nine scenarios in Release Mechanism 3 that involve overflow of contaminated liquid from the waste trenches. The scenarios account for intense precipitation during storms, and cumulative precipitation that occurs during periods when the trench surfaces are exposed due to geomembrane damage or planned replacement.

The following 24-hour and 48-hour storm frequencies apply to the conditions that are evaluated in Scenario 3-1.

Precipitation Range (inches)	24-Hour Storm Frequency (event / year)		48-Hour Storm Frequency (event / year)	
	Mean	95th Percentile	Mean	95th Percentile
4 – 5	1.79E-02	2.30E-02	6.33E-02	8.11E-02
5 – 6	6.33E-03	1.15E-02	1.90E-02	3.46E-02
6 – 7.5	3.51E-03	8.36E-03	1.03E-02	2.19E-02
7.5 – 10	2.10E-03	6.14E-03	5.52E-03	1.31E-02
10 – 12.5	7.78E-04	2.71E-03	1.58E-03	4.39E-03

Precipitation Range (inches)	24-Hour Storm Frequency (event / year)		48-Hour Storm Frequency (event / year)	
	Mean	95th Percentile	Mean	95th Percentile
12.5 – 15	3.29E-04	1.24E-03	6.66E-04	2.18E-03
15 – 17.5	1.88E-04	7.05E-04	3.26E-04	1.12E-03
17.5 – 20	9.75E-05	3.56E-04	1.04E-04	3.68E-04
20 – 22.5	4.63E-05	1.59E-04	6.90E-05	2.57E-04
22.5 – 25	3.99E-05	1.24E-04	3.49E-05	1.32E-04
> 25	8.54E-05	2.43E-04	7.04E-05	2.64E-04

Scenarios 3-2, 3-5, and 3-8 account for high winds and tornadoes that damage the geomembranes with accompanying intense precipitation. Section 15.3.2.1 lists the 95th-percentile frequencies that apply for these storms. The sensitivity analyses also increase the conditional probabilities for intense precipitation during these storms as follows.

Precipitation during Storm Event (inches)	Nominal Probability	Sensitivity Probability
3	0.75	0.50
6	0.15	0.30
9	0.08	0.15
12	0.02	0.05

The following 14-day precipitation exceedance frequencies also apply to all scenarios, except for the conditions that are evaluated in Scenarios 3-1 and 3-2.

Precipitation (inches)	14-Day Exceedance Frequency (event / year)	
	Mean	95th Percentile
1	223	276
3	35.6	64.8
6	4.81	14.7
9	9.77E-01	3.54
13	5.58E-02	2.10E-01
15	1.55E-02	5.87E-02
16	1.12E-02	4.23E-02

Precipitation (inches)	14-Day Exceedance Frequency (event / year)	
	Mean	95th Percentile
18	3.97E-03	1.49E-02
19	2.76E-03	1.03E-02
21	1.20E-03	4.41E-03
22	7.92E-04	2.90E-03
24	4.06E-04	1.46E-03
25	2.73E-04	9.75E-04

For example, the meteorological data show that there are 223 times per year (mean value) when cumulative precipitation of at least 1 inch occurs during a randomly selected 14 consecutive day period. There is 95% confidence that this amount of precipitation occurs during fewer than 276 randomly selected 14-day periods throughout the year. The 95th percentile exceedance frequencies are used for the sensitivity analyses.

Precipitation affects the frequency of each trench overflow scenario, the rate at which contaminated liquid is released when the trenches overflow (model parameter FR), and the flows in the surrounding streams (model parameter FD). The following table summarizes the sensitivity study results for each scenario.

Scenario	Initiating Event Frequency (event / year)			FR / FD	
	Parameter	Nominal Mean Value	Sensitivity Results	Nominal Mean Value	Sensitivity Results
3-1	IPRECF	8.48E-04	2.13E-03	2.98E-04	2.98E-04
3-2	IWITOR	1.15E-04	3.58E-04	2.99E-04	3.00E-04
3-3	IPRE1	2.23E+02	2.76E+02	4.39E-04	4.33E-04
3-4	IPRE9	9.77E-01	3.54E+00	1.04E-04	1.04E-04
3-5	IWITOR	1.15E-04	3.58E-04	2.55E-04	3.08E-04
	WSPR9	4.43E-01	1.23E+00		
3-6	IPRE9	9.77E-01	3.54E+00	1.04E-04	1.04E-04
3-7	IPRE25	2.73E-04	9.75E-04	5.17E-05	5.17E-05
3-8	IWITOR	1.15E-04	3.58E-04	5.17E-05	5.17E-05
	WSPR25	1.16E-04	8.20E-04		
3-9	IPRE25	2.73E-04	9.75E-04	5.17E-05	5.17E-05

15.3.2.5 Sensitivity Analysis Results

Table 15.3-2 summarizes the integrated SDA risk results from the climate change sensitivity analyses. As noted above, the QRA team does not believe that the extreme meteorological conditions that are evaluated by these analyses will evolve over the next 30 years. However, even if these conditions were to apply throughout the 30-year study period beginning in 2010, the mean total SDA risk may increase by a factor of only approximately 2.3, compared to the baseline risk assessment. Approximately 75% of the risk increase is attributed to trench overflow Scenario 3-4, which is particularly sensitive to moderate- to high-precipitation conditions. Groundwater release Scenario 1-2 accounts for essentially all of the remaining difference, due primarily to the increased probability that trench water levels are at the WLT / ULT interface. The sensitivity results also confirm that a release which results in a dose of 100 mrem in 1 year, or more, to an offsite receptor remains very unlikely during the next 30 years of SDA operation.

Table 15.3-1. Maximum 24-Hour Precipitation					
Buffalo (1922 – 2007)		Dunkirk (1926 – 2007)		West Valley (1991 – 2007)	
Date	Precipitation (inches)	Date	Precipitation (inches)	Date	Precipitation (inches)
6/22/1987	5.01	8/22/1942	6.88	6/26/1998	3.75
9/14/1979	4.94	9/14/1979	5.81	8/31/2005	2.25
8/7/1963	3.88	7/29/1983	4.41	9/17/2004	1.99
8/22/1980	3.80	8/8/1979	3.46	11/1/1994	1.90
4/29/1973	3.78	4/23/1977	3.32	9/9/2004	1.90
2/27/1973	3.69	8/1/1986	3.32	8/30/2005	1.88
8/17/1944	3.65	9/14/1972	3.25	8/20/1999	1.86
7/29/1963	3.38	9/2/1980	3.17	6/13/1994	1.81
9/9/2004	3.24	8/6/1956	2.96	11/2/1999	1.74
1/28/1934	3.11	7/29/1976	2.88	5/19/1997	1.70
6/9/1989	3.01	8/1/1979	2.88	7/15/2004	1.68
10/1/1945	3.00	7/4/1935	2.85	8/28/1992	1.64
7/5/1986	2.99	11/5/1985	2.78	5/11/1996	1.57
5/19/1986	2.85	9/16/2005	2.76	11/8/1996	1.57
6/24/1994	2.70	6/18/1937	2.74	11/9/2005	1.56
10/6/1955	2.65	6/13/1962	2.70	7/12/2006	1.56
3/17/1936	2.62	5/20/1986	2.68	10/23/2007	1.56
8/3/1980	2.56	8/24/1968	2.60	6/24/1997	1.54
6/23/1928	2.42	9/18/1945	2.56	4/24/1992	1.52
7/22/1927	2.41	10/1/1959	2.52	9/8/2004	1.52

Table 15.3-2. Climate Change Sensitivity Analysis Results (Page 1 of 3)							
Scenario	Mean Frequency (event / year)	Mean Dose (mrem in 1 year)	Mean Frequency x Dose [(mrem in 1 year) / year]	Fraction of Total Risk	Cumulative Fraction of Total Risk	Contributing Conditions	
3 – 4	4.15E-03	69.66	2.89E-01	4.68E-01	0.468	Overflow, Level = ULT / WLT, > 9 inches in 14 days	
1 – 2	9.00E-04	174.95	1.57E-01	2.55E-01	0.723	Groundwater, Level = ULT / WLT, ULT Lateral	
4 – 1c	5.77E-05	1096.01	6.32E-02	1.02E-01	0.825	Local Landslide or Seismic Damage 1, Level = Current / Low, Liquids	
4 – 1	5.93E-05	539.60	3.18E-02	5.15E-02	0.877	Local Landslide or Seismic Damage 1, Solids	
2 – 1	3.00E-05	683.01	2.05E-02	3.32E-02	0.910	Groundwater, Level = High, WLT Lateral	
1 – 3	3.07E-02	0.59	1.83E-02	2.96E-02	0.939	Groundwater, Level = Current, ULT Lateral	
1 – 4	3.33E-02	0.35	1.17E-02	1.90E-02	0.958	Groundwater, ULT-KRS	
1 – 1	3.00E-05	290.64	8.72E-03	1.41E-02	0.972	Groundwater, Level = High, ULT Lateral	
3 – 3	1.86E-05	290.55	5.41E-03	8.76E-03	0.981	Overflow, Level = High, Surface Disturbed, > 1 inch in 14 days	
4 – 1b	1.60E-06	2283.36	3.66E-03	5.92E-03	0.987	Local Landslide or Seismic Damage 1, Level = WLT / ULT, Liquids	
3 – 5	1.69E-05	206.88	3.50E-03	5.67E-03	0.993	Overflow, Level = ULT / WLT, Wind or Tornado, > 9 inches in 14 days	
3 – 7	3.90E-05	34.78	1.36E-03	2.20E-03	0.995	Overflow, Level = Current / Low, > 25 inches in 14 days	

Table 15.3-2. Climate Change Sensitivity Analysis Results (Page 2 of 3)

Scenario	Mean Frequency (event / year)	Mean Dose (mrem in 1 year)	Mean Frequency x Dose [(mrem in 1 year) / year]	Fraction of Total Risk	Cumulative Fraction of Total Risk	Contributing Conditions
4 – 3c	8.54E-07	1187.35	1.01E-03	1.64E-03	0.997	Seismic Damage 2, Level = Current / Low, Liquids
4 – 2c	5.47E-07	1096.01	5.99E-04	9.70E-04	0.998	Gully Erosion, Level = Current / Low, Liquids
3 – 6	6.96E-06	69.46	4.83E-04	7.83E-04	0.998	Overflow, Level = ULT / WLT, Surface Disturbed, > 9 inches in 14 days
4 – 3	8.79E-07	361.82	3.21E-04	5.19E-04	0.999	Seismic Damage 2, Solids
4 – 2	5.62E-07	539.60	3.03E-04	4.91E-04	0.999	Gully Erosion, Solids
4 – 1a	5.34E-08	4749.39	2.54E-04	4.10E-04	1.000	Local Landslide or Seismic Damage 1, Level = High, Liquids
4 – 3b	2.37E-08	2740.03	6.50E-05	1.05E-04	1.000	Seismic Damage 2, Level = WLT / ULT, Liquids
4 – 2b	1.52E-08	2283.36	3.47E-05	5.61E-05	1.000	Gully Erosion, Level = WLT / ULT, Liquids
3 – 8	4.19E-07	34.78	1.46E-05	2.36E-05	1.000	Overflow, Level = Current / Low, Wind or Tornado, > 25 inches in 14 days
4 – 4c	4.89E-09	2557.37	1.25E-05	2.02E-05	1.000	Global Landslide, Level = Current / Low, Liquids
5 – 1	3.69E-07	18.18	6.66E-06	1.08E-05	1.000	Aircraft crash or meteorite
3 – 2	4.59E-07	14.38	6.60E-06	1.07E-05	1.000	Overflow, Level = High, Wind or Tornado

Table 15.3-2. Climate Change Sensitivity Analysis Results (Page 3 of 3)

Scenario	Mean Frequency (event / year)	Mean Dose (mrem in 1 year)	Mean Frequency x Dose [(mrem in 1 year) / year]	Fraction of Total Risk	Cumulative Fraction of Total Risk	Contributing Conditions
4 – 3a	7.91E-10	5662.74	4.48E-06	7.25E-06	1.000	Seismic Damage 2, Level = High, Liquids
3 – 9	7.30E-08	34.78	2.54E-06	4.11E-06	1.000	Overflow, Level = Current / Low, Surface Disturbed, > 25 inches in 14 days
3 – 1	8.67E-08	28.60	2.48E-06	4.01E-06	1.000	Overflow, Level = High, 24- or 48-Hour Storm
4 – 2a	5.06E-10	4749.39	2.40E-06	3.89E-06	1.000	Gully Erosion, Level = High, Liquids
4 – 4b	1.36E-10	6028.08	8.18E-07	1.33E-06	1.000	Global Landslide, Level = WLT / ULT, Liquids
4 – 4	5.03E-09	24.95	1.17E-07	1.89E-07	1.000	Global Landslide, Solids
4 – 4a	4.53E-12	9772.79	4.42E-08	7.16E-08	1.000	Global Landslide, Level = High, Liquids

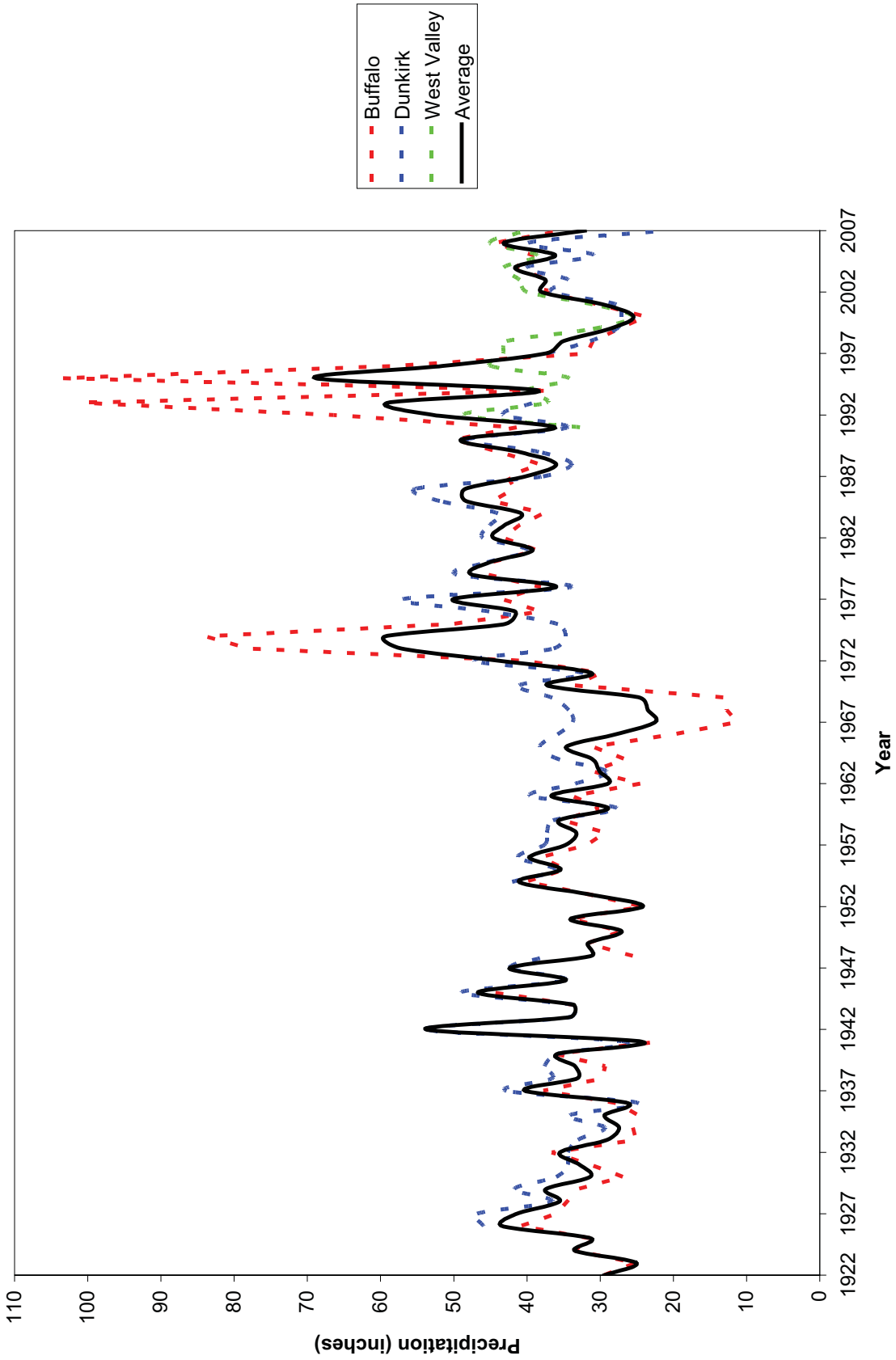

Figure 15.3-1. Annual Precipitation Data